

Top[®]
Light

LIGHT FOR LIVING

2021/2022



Design by[®]

R
Z
Raif Ziel

Ausgezeichnete Leuchten in bestem Design



INDUSTRIEPREIS
2015



PLUS X AWARD
2015/2016



PLUS X AWARD
2016/2017



LICHT + CONCEPT
LIEFERANT DES JAHRES
2016



PLUS X AWARD
2016/2017



PLUS X AWARD
2017/2018



PLUS X AWARD
2018



HOME TREND AWARD
2017/2018



GERMAN DESIGN AWARD
2019



LICHT + CONCEPT
LIEFERANT DES JAHRES
2020



GERMAN BRAND AWARD
2020



GERMAN BRAND AWARD
EXCELLENT BRANDS LIGHTING
2021



GERMAN BRAND AWARD
PRODUCT BRAND OF THE YEAR
2021



PLUS X AWARD
2021/2022



Lieber Top Light Kunde,

wir freuen uns Ihnen den Top Light Hauptkatalog »Light for Living« Upgrade 2021/22 präsentieren zu dürfen.

Gut strukturiert, übersichtlich, mit vielen neuen Produkten und Anwendungen, überzeugt er in allen Bereichen durch neue Oberflächen und Techniken.

So wurden wir 2021 nicht nur zum zweiten mal Gewinner des begehrten EK Licht & Konzept Servicepreises, sondern erhielten auch, neben anderen zahlreichen Designpreisen, zum dritten mal in Folge den „PLUS X AWARD“ für höchste Kundenzufriedenheit. Dies ist ein Zeichen, dass wir bei Service und Design zu den Besten der Branche gehören.

Wir möchten uns an dieser Stelle bei all unseren Kunden für ihre Treue und das in uns gesetzte Vertrauen herzlich bedanken.

Wir wünschen Ihnen und Ihrer Familie weiterhin Gesundheit, Glück und Erfolg, besonders in diesen Zeiten der Veränderung, Anpassung und Pandemie.

Herzlichst Ihr

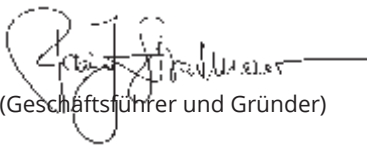

(Geschäftsführer und Gründer)

Dear Top Light customer,

We are pleased to present the Top Light main catalogue "Light for Living" Upgrade 2021/22.

Well-structured, clearly arranged, with many new products and applications, it convinces in all categories with new surfaces and techniques.

In 2021, we won the coveted EK Light & Concept Service Award for the second time and we also received the "PLUS X AWARD" for highest customer satisfaction for the third time in a row, in addition to other numerous design awards. This is a proof that we are among the best in the industry when it comes to service and design.

We would like to take this opportunity to thank all our customers for their loyalty and the trust they have placed in us.

We wish you and your family health, happiness and continued success, especially in these times of change, adjustment and pandemic.



(Managing Director and Founder)

Bestellhinweise:

Bezugsquelle

Top Light Produkte sind ausschließlich über unsere Fachhandelspartner zu beziehen.

Bestellungen/Lieferungen

Angebote sind freibleibend und werden nur durch unsere schriftliche Bestätigung unter Zugrundelegung unserer AGB wirksam. Mündliche Vereinbarungen bedürfen der schriftlichen Bestätigung.

Inhalt

Die Firma Top Light behält sich technische Änderungen vor. Für die Richtigkeit von technischen Angaben sowie Farbabweichungen wird keine Gewähr übernommen.

Produkte

Für viele Top Light Leuchten sind nationale und internationale Schutzrechte wie Patente, Gebrauchsmuster, Geschmacks- oder Markenrechte eingetragen.

Produktdesign: Rolf Ziel

Order Information

Source

Top Light products are only available through our qualified dealers.

Orders/Deliveries

All quotes are without obligation and are binding only after our written order confirmation based upon our General Terms of Business. Verbal agreements must be confirmed in writing.

Content

The firm Top Light reserves technical changes. No guarantee is given for the correctness of technical statements and differences in colors.

Products

For many Top Light lamps national and international protection rights such as patents, utility patents, design patents or trademark rights are registered.

Product design: Rolf Ziel

Follow us:



Top Light GmbH & Co. KG

Industriezentrum 100
32139 Spenge

fon +49 (0) 52 25 . 8 63 12 - 0
fax +49 (0) 52 25 . 8 63 12 - 10

www.top-light.de
www.orange-one.de
brief@top-light.de

Design by®

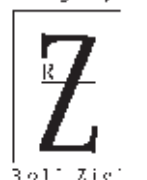

Top Light Infos & Icons

Alle LED Leuchtmittel der früheren Energieeffizienzklasse »A bis A++« werden nach der neuen Verordnung in die Energieeffizienzklasse »G bis F« eingestuft. Wir behalten uns vor, dass techn. Angaben und Preise der Leuchtmittel sich aufgrund der techn. Weiterentwicklung ändern können. Sowohl bei bestellen, als auch bei den von Top Light beigelegten Leuchtmitteln. Nicht alle Retrofits sind dimmbar. LED-Retrofit auch im Handel erhältlich.

All LED illuminants of the former energy efficiency class A to A++ are classified in the energy efficiency class G to F according to the new regulation. We reserve the right to change the technical specifications and prices of the lamps due to technical developments. This applies to both the illuminants ordered and those supplied by Top Light. Not all retrofits are dimmable. LED retrofits are also available in stores.

	Kennzeichnung zur Konformitätserklärung des Herstellers über die Einhaltung bestehender EG-Richtlinien.	Proof of manufacturer's conformity with existing European directives.
	IP (Ingress Protection), Schutzart-Klassifizierung IP20 = Geschützt gegen das Eindringen von festen Fremdkörpern > 12 mm.	IP (Ingress Protection), Protection classification IP20 = Protected against ingress by solid foreign objects > 12 mm.
	Schutzklasse I: Leuchten mit Schutzleiteranschluss.	Protection class I: Lamps with earth conductor connection.
	Schutzklasse II: Leuchten mit einer zusätzlichen oder verstärkten Schutzisolierung.	Protection class II: Lamps with additional or reinforced protective insulation.
	Schutzklasse III: Leuchten im Niederspannungsbereich.	Protection class III: Lamps in low-voltage range.
	IP (Ingress Protection), Schutzart-Klassifizierung IP44 = Geschützt gegen das Eindringen von festen Fremdkörpern > 1 mm und gegen Spritzwasser aus allen Richtungen.	IP (Ingress Protection), Protection classification IP44 = Protected against ingress by solid foreign objects > 1 mm and against splashing water from any direction.
	Dimmbar mit Standard-Phasenabschnittdimmer für Glühlampen.	Dimmable with standard leading edge dimmer for incandescent lamps.
	Dimmbar mit Standard-Phasenabschnittdimmer für LED.	Dimmable with standard leading edge dimmer for LED.
	Dimmbar mit Standard-Phasenabschnittdimmer für elektronische Transformatoren.	Dimmable with standard leading edge dimmer for electronic transformers.
	Vorschaltgerät ist mit 1-10V-Steuergerät dimmbar.	Ballast is dimmable with a 1-10V control unit.
	Vorschaltgerät ist mit DALI-Steuergerät dimmbar.	Ballast is dimmable with a DALI control unit.
	Separater Lichtschalter am Leuchtengehäuse.	Separate light switch on lamp housing.
	Elektronischer Transformator.	Electronic transformer.
	Elektronisches Vorschaltgerät (EVG).	Electronic ballast.
	Vorschaltgerät ist ausgelegt für zwei unterschiedliche Wattagen.	Ballast can operate two different wattages.

Casambi-Bau-Varianten:

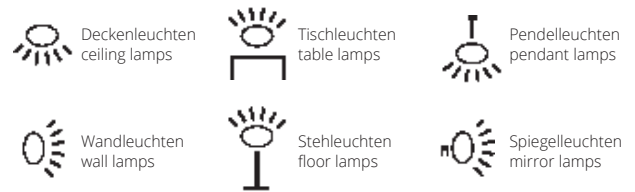

Energieeffizienzklassen

Alle angegebenen Energieeffizienzklassen rangieren auf einer Skala von A (sehr effizient) bis G (weniger effizient).



Für unsere LED Leuchten empfehlen wir folgende Dimmer:
For our LED lamps we recommend the following dimmer:

- Eltako EUD61NPN-UC (mit serienmäßigem Taster einsetzbar)
- Theben Dimax 544 plus p

Dimmen über Smarthome: Casambi TED

Austauschbare Leuchtmittel

Mit den Retro Fits wurden LED-Ersatzleuchtmittel ähnlicher Baugröße, wie die Halogenleuchtmittel geschaffen. Die rasche Entwicklung der LED Technik hat zur Konsequenz, dass auch die Leuchtmittel permanent angepasst werden müssen. Diese Anpassungen finden regelmäßig, fast halbjährlich statt. Abweichungen der Leuchtmittel lassen sich aus diesem Grund nicht vermeiden. Leuchtmittel, die wir zu unseren Produkten beilegen, sind kostenlose Beigaben und stellen keinen Anspruch dar. Sie sind Betriebsmittel und unterliegen keiner Gewährleistung. Wir arbeiten aber ständig daran, einen hohen Qualitätsanspruch zu erreichen.

Replaceable illuminants

The rapid development of LED technology means that the light sources also have to be permanently adapted. These adjustments take place regularly, almost every six months. For this reason, deviations of the lamps cannot be avoided. Illuminants that we enclose with our products are free of charge and do not constitute a claim. They are operating materials and are not subject to any warranty. However, we are constantly working to achieve a high standard of quality.

In diesem Katalog gezeigte Farben sind ein Hinweis auf das optische Finish und keine Eigenschaftszusicherung. Für die Richtigkeit von technischen Angaben, sowie Farbabweichungen, wird keine Gewähr übernommen. Alle Maßangaben sind unverbindlich und können geringfügige Abweichungen aufweisen. Technische Änderungen vorbehalten!

Colours shown in this catalogue are an indication of the visual finish and not a guarantee of characteristic. No responsibility is taken for the correctness of the technical specifications or for colour deviations. All dimensions are non-binding and may show slight deviations. We reserve the right to make technical changes!

Top Light Serviceleistungen

- 1 5-Jahre Garantie**
Bedingungen finden Sie auf unserer homepage www.top-light.de
 - 2 7-Tage Reparaturservice**
 - 3 Technische Beratung**
 - 4 Reparaturen zum Selbstkostenpreis**
 - 5 Telefonische Bestellung**
 - 6 Spiegelfertigung auf Maß**
 - 7 Sonderanfertigungen von unserem Konstruktionsteam nach Absprache möglich**
 - 8 Projektschutz**
Nur bei vorgelegter Planung
 - 9 Kostenlose Planung von Shop in Shop Systemen**
 - 10 Service-Hotline +49 (0) 52 25 . 8 63 12 - 0**
 - 11 Verlinkung unserer Premium-Partner auf der Top Light Homepage**
 - 12 Lichtplanung**
 - 13 Lichtberatung**
 - 14 Schnelle Auftragsbearbeitung**
 - 12 Flagship-Store in Bielefeld**
 - 15 Weltweiter Versand**
 - 16 2-sprachige Beratung**
 - 17 Keine Mindestbestellmenge**
- 1 5-year warranty**
Terms and conditions can be found on our homepage www.top-light.de
 - 2 7-day repair service**
 - 3 Technical consultation**
 - 4 Repairs at a reasonable cost**
 - 5 Order by telephone**
 - 6 Made to measure mirror production**
 - 7 Special designs by our design team possible by arrangement**
 - 8 Project protection**
Only with presented planning
 - 9 Free planning of shop-in-shop systems**
 - 10 Service hotline +49 (0) 52 25 . 8 63 12 - 0**
 - 11 Links to our premium partners on the Top Light homepage**
 - 12 Lighting design**
 - 13 Lighting consultation**
 - 14 Fast order processing**
 - 12 Flagship store in Bielefeld**
 - 15 Worldwide shipping**
 - 16 2-language consultation**
 - 17 No minimum order quantity**



So bestelle ich.

1. Wenn Sie bereits eine unserer Leuchten besitzen und das Lighting Control Modul nachrüsten möchten, müssen Sie unbedingt bei der Bestellung Modell und Artikelnr. der vorhandenen Leuchte angeben.
2. Bestellen Sie eine neue Leuchte und möchten das Lighting Control Modul integriert haben, dann geben Sie zu der Artikelnr. der Leuchte die Artikelnr. der gewünschten Modul Variante an.

How to order.

1. In case you already own lights of Top Light and want to equip them with Lighting Control, please indicate your type of lamp and item number with the order of the Lighting Control Modul.
2. In case you want to order a new lamp with integrated Lighting Control Module, please indicate the lamp and item number as well as the Control version you need.

Welche Leuchten funktionieren mit dem Modul?

Dieses Zeichen finden Sie auf den Seiten der Leuchten, die mit der Lighting Control ausgestattet werden können. Der oder die jeweiligen Buchstaben geben an, welche der vier aufgeführten Varianten realisierbar ist (s. rechte Seite).

Which lamp works with the modul?

All lightning fixtures which can be equipped with Lightning Control are marked with the following logo on each page. The letter indicates which of the four versions is possible for the lamp (see right page).



Modul-Kennung
auf allen
Produktseiten

Top Light Lighting Control

Ermöglicht über Bluetooth das Dimmen, Schalten und Steuern einzelner Leuchten oder Leuchtengruppen, sowie das Programmieren von Lichtszenen für das perfekte Wohlfühllicht. Außerdem bietet die Zeitschaltung Sicherheit bei Abwesenheit.

Enables via Bluetooth to dim, switch and control individual luminaires or luminaire groups, as well as to programme light scenes for the perfect feel-good light. In addition, the time switch offers security in case of absence.

Modul-Kennung für Ihre Top Light Leuchte

Passend für alle Wand-, Decken-, Pendelleuchtenmontagen und für alle Spiegel, möglich auch für Steh- und Tischleuchten.
Fits for all wall, ceiling and pendula lamp mounting and for all illuminated mirrors, also available for floor and table lamps.



- | | | | | |
|---|--|---|---|--|
| <p>A Aufbau Variante
integriert oder nachrüstbar, inkl. Baldachinanpassung mit Modul.
Mounted version
Integrated and upgradable</p> | <p>B Einbauvariante
Schalterdose/ U-Dose extern, inkl. Abdeckplatte und Modul.
Recessed version
Switch box U-Box /external</p> | <p>C Einbauvariante
extern für Hohlwanddeckenmontage, inkl. Modul
Recessed version
external</p> | <p>D Einbauvariante
intern im Wandschild, inkl. Modul
Recessed version
Included in wall- shield, incl. module</p> | <p>D SPIEGEL-Variante
Einbau hinter dem Spiegel, inkl. Modul
Mirror version
Included behind the mirror, incl. module</p> |
|---|--|---|---|--|

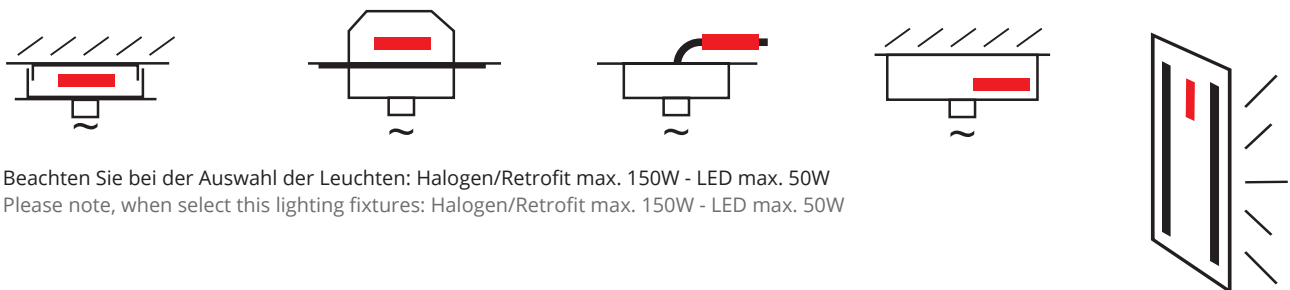

Beachten Sie bei der Auswahl der Leuchten: Halogen/Retrofit max. 150W - LED max. 50W
Please note, when select this lighting fixtures: Halogen/Retrofit max. 150W - LED max. 50W

Preise und Bestellnummern Prices and item-numbers

A	B	C	D	Gehäuse body
A. Modul integriert integrated	B. Modul Einbau recessed	C. Modul extern external	D. Modul integriert integrated	white
7-971	7-972	7-973	7-974	
Fernbedienung portabel + Wandhalterung Remote portable + wall holder			Gehäuse body	
7-978			white	
7-979			black	



Fernbedienung

Modulbeispiel

Inklusive kostenlosem »Casambi App« Download:
Download the free »Casambi App«:



Puk Mini, Puk Maxx & Puk Meg Maxx

Kopf-Konfigurationen Head configuration

We are family. Lernen Sie alle Mitglieder der Puk-Familie kennen. Become acquainted with all the members of the Puk family.



Puk Kopf-Konfiguration (frei wählbar)

Puk Configuration (freely selectable)

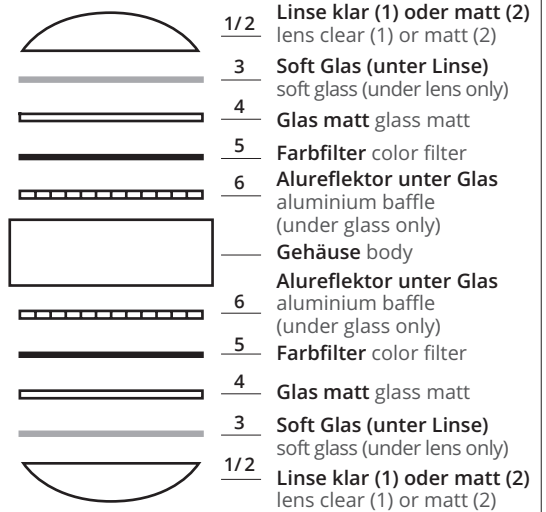

Puk Mini Wall LED: Kopf-Konfigurationen Head configuration

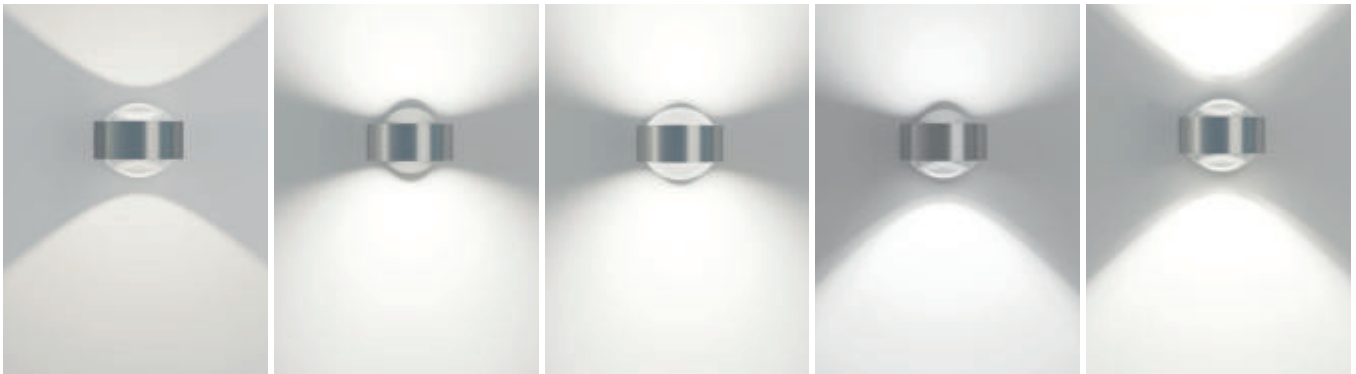

2 x Soft Glas, Linse klar
2 x soft glass, lens clear

Glas matt/Glas matt
glass matt/glass matt

Linse matt/Linse matt
lens matt/lens matt

Glas matt/Linse klar
glass matt/lens clear

Linse klar/Linse klar
lens clear/lens clear

Puk Maxx Wall LED: Farbfilter Color Filter

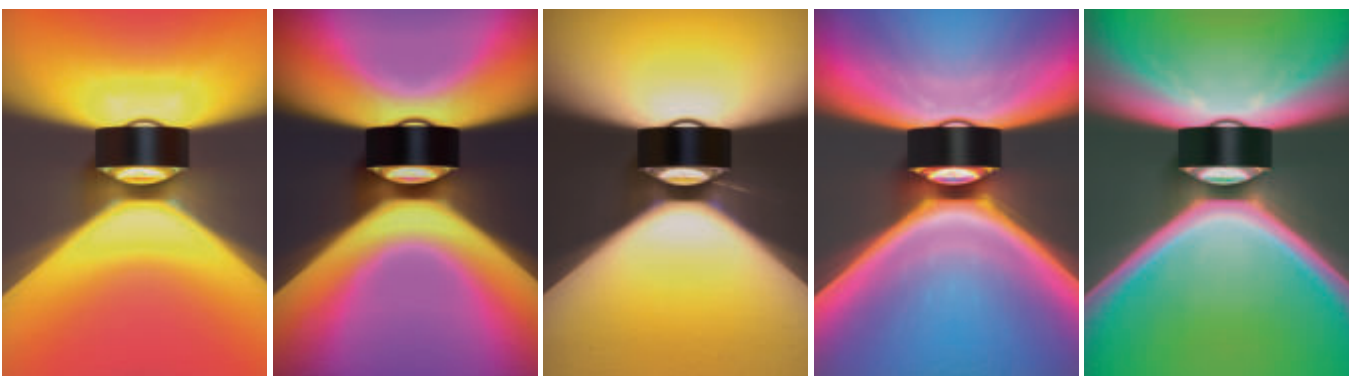

Farbfilter rot
color filter red

Farbfilter magenta
color filter magenta

Farbfilter gelb
color filter yellow

Farbfilter blau
color filter blue

Farbfilter grün
color filter green

Puk Mini, Puk Maxx & Puk Meg Maxx

Diese intelligente und moderne Leuchtenserie bietet Wand-, Decken-, Spiegel-, Pendel-, Steh- und Tischleuchten in verschiedenen Oberflächen. Auf dieser Seite sehen Sie die Möglichkeiten der Bestückung mit Linse, Glas, Lichtstopp und Farbfilter – egal ob Halogen oder LED.

This smart and modern lighting range offers wall, ceiling, mirror, pendula, floor and table lamps with various surfaces. On this page we show the possibilities of equipment with lens, glass, lightstop and color filter - no matter whether halogen or LED.



Puk Meg Maxx
ø 160 mm



Puk Mini Plus
ø 80 mm



Puk Maxx Plus
ø 120 mm

Puk Mini Wall: Oberflächen Surfaces

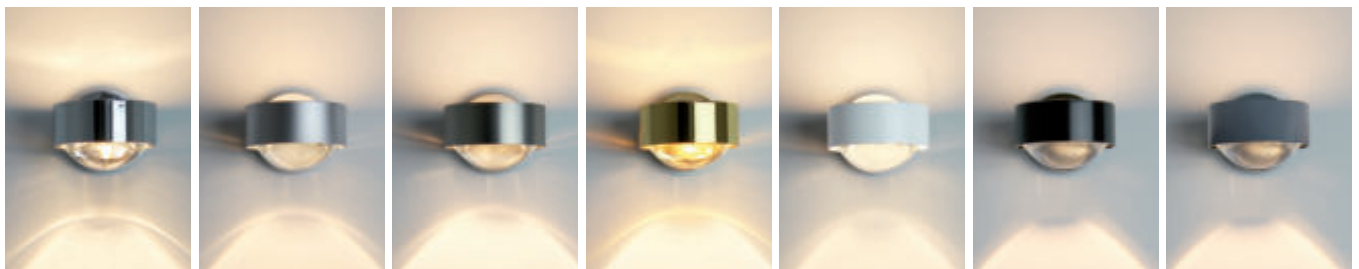

chrom
chrome

chrom matt
chrome matt

nickel matt
nickel matt

gold
gold

weiß matt
white matt

schwarz matt
black matt

anthrazit matt
anthracite matt



OVERVIEW LIGHT FOR LIVING *... and Office!*

INDOOR	12 - 289
1. Deckenleuchten/Einbauleuchten	14 - 107/108 - 111
2. Wandleuchten	112 - 175
3. Steckerleuchten	176 - 183
4. Pendelleuchten	184 - 237
5. Stehleuchten	238 - 265
6. Tischleuchten	266 - 289

SYSTEM	290 - 347
1. Mini Track	292 - 307
2. Top Line: Ceiling , Gallery, Crown	308 - 341
3. Eutrac	342 - 347

BATH & WELLNESS	348 - 419
1. Spiegelleuchten	352 - 375
2. Design LED-Lichtspiegel	376 - 419

OUTDOOR	420 - 464
1. Deckenleuchten	424 - 439
2. Wandleuchten	440 - 445
3. Pollerleuchten	446 - 449
4. Schirmleuchten	450 - 453
5. Bodeneinbauleuchten	454 - 464

SPEZIALS	465 - 493
-----------------	------------------

INDOOR

1. Deckenleuchten	14 - 107
Einbauleuchten	108 - 111
2. Wandleuchten	112 - 175
3. Steckerleuchten	176 - 183
4. Pendelleuchten	184 - 237
5. Stehleuchten	238 - 265
6. Tischleuchten	266 - 289

Leuchten geben einem Neubau oder renovierten Immobilien erst den letzten Schliff. Sie vervollkommen das stilistische Bild der Architektur. Deshalb finden sich in unserem Programm Designerlampen, die diesem Anspruch genügen und jede Architektur stilvoll abrunden. Die energiesparende LED Technologie steht immer mehr im Focus. Auf Wunsch finden Sie aber auch viele Modelle mit Halogenfassung in unserem Programm.

Luminaires add the finishing touch to a new build or renovated property. They enhance the stylistic image of the architecture. That is why our range includes designer lamps that meet this requirement and stylishly round off any architecture. The focus is increasingly on energy-saving LED technology. On request, however, you will also find many models with halogen sockets in our range.

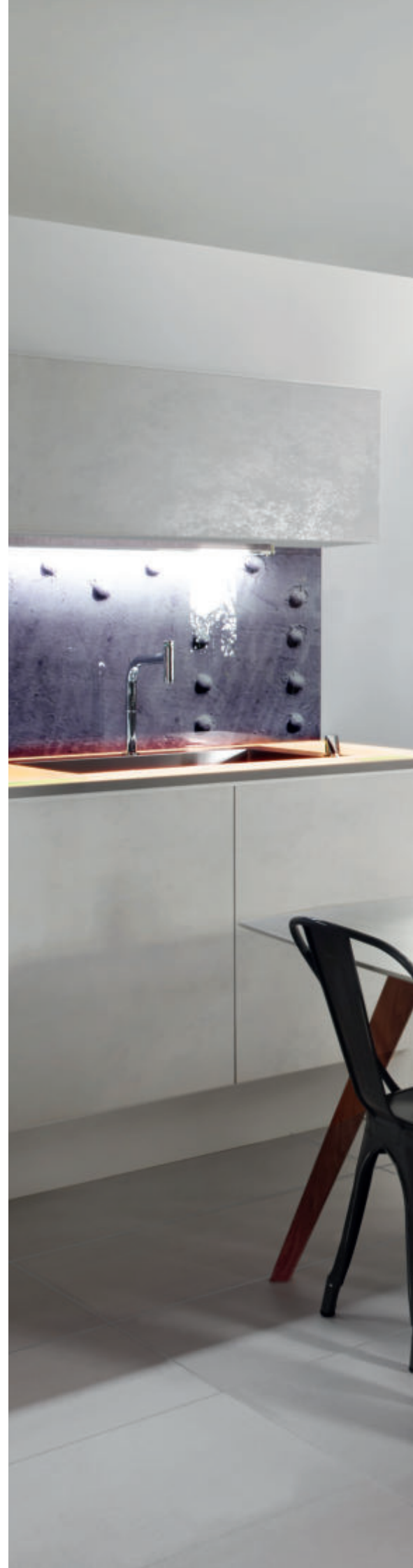





DECKENLEUCHTEN

CEILING LAMPS



Puk Mini One 17



Puk Mini One 2 19
Puk Maxx One 2 21



Puk Mini Plus 23
Puk Maxx Plus 25
Puk Meg Maxx Plus 27



Puk Mini Turn 29
Puk Maxx Turn 31



Puk Mini Move 33
Puk Maxx Move 35



Puk Mini Eye Ceiling 37
Puk Maxx Eye Ceiling 39
Puk Meg Maxx Eye Ceiling 41



Puk Mini Side Single 43
Puk Maxx Side Single 45



Puk Mini Side Twin 47
Puk Maxx Side Twin 49



Puk Mini Wing Single 51
Puk Maxx Wing Single 53



Puk Mini Wing Twin 55
Puk Maxx Wing Twin 57



Puk Maxx Next 59
Puk Meg Maxx Next 61



Puk Mini Ceiling Sister 63
Puk Maxx Ceiling Sister 65



Puk Mini Move Choice 67
Puk Maxx Move Choice 69



Puk Mini Turn Choice 71
Puk Maxx Turn Choice 73



Puk Mini Eye Choice 75
Puk Maxx Eye Choice 77



Puk Mini Side Choice 79
Puk Maxx Side Choice 81

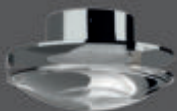

Paxx 83



Allround 85



Allround Flat 87



Foxx Round 89



Foxx Cube 91



Sun Ceiling 93



Sun Ceiling Choice downlight 95
Sun Ceiling Choice uplight 97



Only Choice 99



Dela 101



Dela Box 103



Quadro 105



Quadro Box 107



Puk Mini Inside 109
Puk Maxx Inside 111





Puk Mini One Ø 80

Deckenleuchte, Hochvolt Halogen oder LED Power, dimmbar.
Ceiling lamp, high voltage halogen or LED power, dimmable.

INDOOR

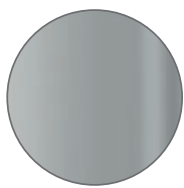

chrome matt



nickel matt

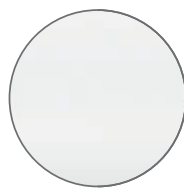

white matt

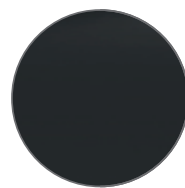

black matt

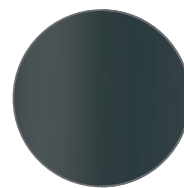

anthracite matt

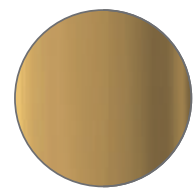

24c gold

Puk Mini One LED 8W ~600lm ~2.700k	Puk Mini One G9 Fassung	Ø x Höhe Ø x height in mm	Gehäuse body
2-08001-LED	2-08001	80 x 33	chrome matt
2-08002-LED	2-08002	80 x 33	chrome
2-08003-LED	2-08003	80 x 33	nickel matt
2-08002-LED-22	2-08002-22	80 x 33	white matt
2-08002-LED-02	2-08002-02	80 x 33	black matt
2-08002-LED-23	2-08002-23	80 x 33	anthracite matt
2-08006	2-08006	80 x 33	24 c. gold plated

▶ Ohne Zubehör. Bestell-Artikelnummern für Linse, Glas, Farbfilter und die Konfigurationsempfehlung (2) auf der Einklappseite!

▶ Without accessories: Order item-no. for lens, glass, color filter and the recommended Configuration (2) are on the fold-in page!

G9 max. 33W ECO, optional LED Retrofit
 G9 max. 33W ECO, LED Retrofit optional

Leuchtmittelempfehlung: LED max. 3W/300lm/2.700K/dimmbar Art Nr. 8-205
 bulb recommendation: LED max. 3W/300Lm/2.700K/dimmable Item No. 8-205

Chrom Teile/
chrome parts
 Gepulverte Teile/
powder-coating

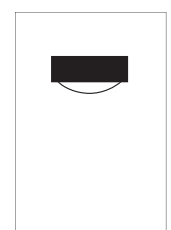
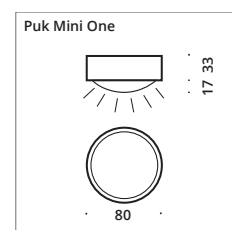





Puk Mini One 2 ø 80

Deckenleuchte, Hochvolt Halogen oder LED Power, dimmbar.
Ceiling lamp, high voltage halogen or LED power, dimmable.

INDOOR

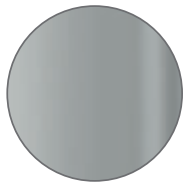

chrome matt



nickel matt

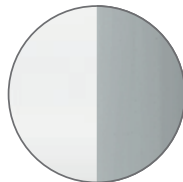

white matt/
chrome

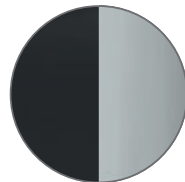

black matt/
chrome

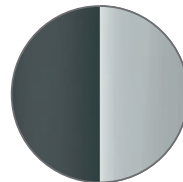

anthracite matt/
chrome

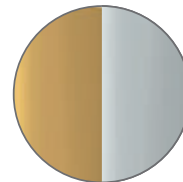

24c gold/
chrome

Puk Mini One 2 LED G 8W ~600lm ~2.700k	Puk Mini One 2 G9 Fassung	ø x Höhe ø x height in mm	Gehäuse body
2-080021-LED	2-080021	80 x 40	chrome matt
2-080022-LED	2-080022	80 x 40	chrome
2-080023-LED	2-080023	80 x 40	nickel matt
2-080022-LED-22	2-080022-22	80 x 40	white matt/chrome
2-080022-LED-02	2-080022-02	80 x 40	black matt/chrome
2-080022-LED-23	2-080022-23	80 x 40	anthracite matt/chr.
2-080026	2-080026	80 x 40	24 c. gold plated/chr.

- ▶ Ohne Zubehör. Bestell-Artikelnummern für Linse, Glas, Farbfilter und die Konfigurationsempfehlung (2) auf der Einklappseite!
- ▶ Without accessories: Order item-no. for lens, glass, color filter and the recommended Configuration (2) are on the fold-in page!



G9 max. 33W ECO, optional LED Retrofit
 G9 max. 33W ECO, LED Retrofit optional

Leuchtmittelempfehlung: LED max. 3W/300lm/2.700K/dimmbar **G** Art. Nr. 8-205
 bulb recommendation: LED max. 3W/300Lm/2.700K/dimmable **G** Item No. 8-205

Chrom Teile/
chrome parts
 Gepulverte Teile/
powder-coating

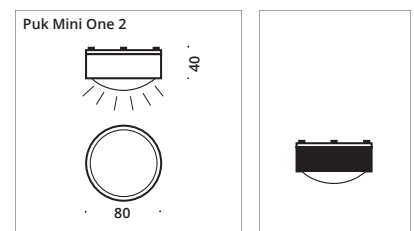

ABC (s.S 6-7/s.p. 6-7)





Puk Maxx One 2 \varnothing 120

Deckenleuchte, Hochvolt Halogen oder LED Power, dimmbar.
Ceiling lamp, high voltage halogen or LED power, dimmable.

INDOOR



chrome

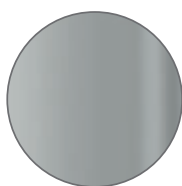

chrome matt

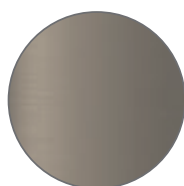

nickel matt

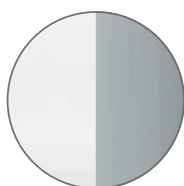

white matt/
chrome

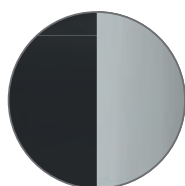

black matt/
chrome

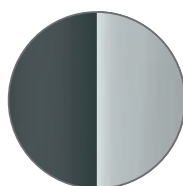

anthracite matt/
chrome

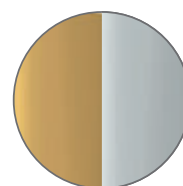

24c gold/
chrome

Puk Maxx One 2 LED G 1 x 12W ~900lm ~2.700k	Puk Maxx One 2 G9 Fassung	\varnothing x Höhe \varnothing x height in mm	Gehäuse body
2-3008001	2-3008001-H	120 x 57,5	chrome matt
2-3008002	2-3008002-H	120 x 57,5	chrome
2-3008003	2-3008003-H	120 x 57,5	nickel matt
2-3008002-22	2-3008002-H-22	120 x 57,5	white matt/chrome
2-3008002-02	2-3008002-H-02	120 x 57,5	black matt/chrome
2-3008002-23	2-3008002-H-23	120 x 57,5	anthracite matt/chr.
2-3008006	2-3008006-H	120 x 57,5	24 ct gold plated/chr.

► Ohne Zubehör. Bestell-Artikelnummern für Linse, Glas, Farbfilter und die Konfigurationsempfehlung (2) auf der Einklappseite!



► Without accessories: Order item-no. for lens, glass, color filter and the recommended Configuration (2) are on the fold-in page!

G9 max. 33W ECO, optional LED Retrofit

G9 max. 33W ECO, LED Retrofit optional

Leuchtmittelempfehlung: LED max. 3W/300lm/2.700K/dimmbar **G** Art. Nr. 8-205
bulb recommendation: LED max. 3W/300Lm/2.700K/dimmable **G** Item No. 8-205

Chrom Teile/
chrome parts
 Gepulverte Teile/
powder-coating

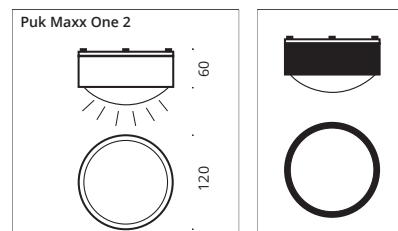

IP20 BC (s.S 6-7/s.p. 6-7)





Puk Mini Plus \varnothing 80

Deckenleuchte, Hochvolt Halogen oder LED Power, dimmbar.
Ceiling lamp, high voltage halogen or LED power, dimmable.

INDOOR



chrome

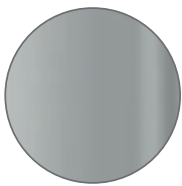

chrome matt

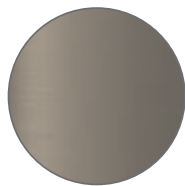

nickel matt

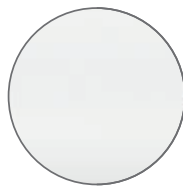

white matt

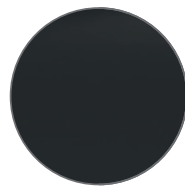

black matt

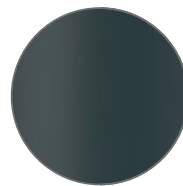

anthracite matt

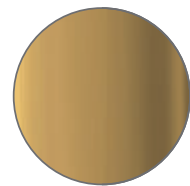

24c gold

Puk Mini Plus LED G 8W ~600lm ~2.700k	Puk Mini Plus G9 Fassung	\varnothing x Höhe \varnothing x height	Gehäuse body
2-18001-LED	2-18001	80 x 53 mm	chrome matt
2-18002-LED	2-18002	80 x 53 mm	chrome
2-18003-LED	2-18003	80 x 53 mm	nickel matt
2-18002-LED-22	2-18002-22	80 x 53 mm	white matt
2-18002-LED-02	2-18002-02	80 x 53 mm	black matt
2-18002-LED-23	2-18002-23	80 x 53 mm	anthracite matt
2-18006-LED	2-18006	80 x 53 mm	24 carat gold plated

► Ohne Zubehör. Bestell-Artikelnummern für Linse, Glas, Farbfilter und die Konfigurationsempfehlung (2) auf der Einklappseite!

► Without accessories: Order item-no. for lens, glass, color filter and the recommended Configuration (2) are on the fold-in page!

G9 max. 33W ECO, optional LED Retrofit

G9 max. 33W ECO, LED Retrofit optional

Leuchtmittelempfehlung: LED max. 3W/300lm/2.700K/dimmbar **G** Art. Nr. 8-205
 bulb recommendation: LED max. 3W/300Lm/2.700K/dimmable **G** Item No. 8-205

Chrom Teile/
chrome parts
 Gepulverte Teile/
powder-coating

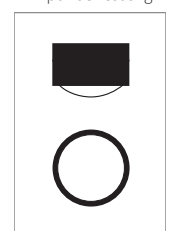
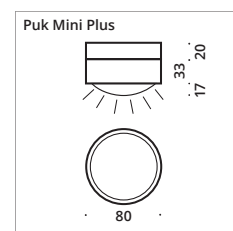

ABC (s.S 6-7/s.p. 6-7)





Puk Maxx Plus \varnothing 120

Deckenleuchte, Hochvolt Halogen oder LED Power, dimmbar.
Ceiling lamp, high voltage halogen or LED power, dimmable.

INDOOR



chrome

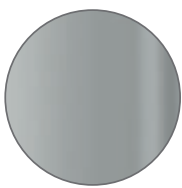

chrome matt

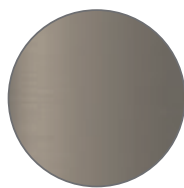

nickel matt

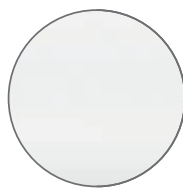

white matt

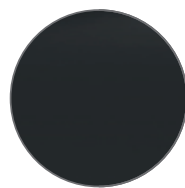

black matt

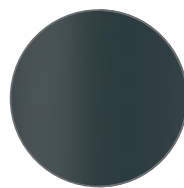

anthracite matt

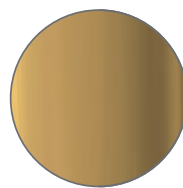

24c gold

Puk Maxx Plus LED G 12W ~900lm ~2.700k	Puk Maxx Plus G9 Fassung	\varnothing x Höhe \varnothing x height	Gehäuse body
2-3018001	2-3018001-H	120 x 91 mm	chrome matt
2-3018002	2-3018002-H	120 x 91 mm	chrome
2-3018003	2-3018003-H	120 x 91 mm	nickel matt
2-3018002-22	2-3018002-H-22	120 x 91 mm	white matt
2-3018002-02	2-3018002-H-02	120 x 91 mm	black matt
2-3018002-23	2-3018002-H-23	120 x 91 mm	anthracite matt
2-3018006	2-3018006-H	120 x 91 mm	24 ct gold plated

► Ohne Zubehör. Bestell-Artikelnummern für Linse, Glas, Farbfilter und die Konfigurationsempfehlung (2) auf der Einklappseite!

► Without accessories: Order item-no. for lens, glass, color filter and the recommended Configuration (2) are on the fold-in page!

G9 max. 33W ECO, optional LED Retrofit
 G9 max. 33W ECO, LED Retrofit optional

Leuchtmittelpfehlung: LED max. 3W/300lm/2.700K/dimmbar **G** Art. Nr. 8-205
 bulb recommendation: LED max. 3W/300Lm/2.700K/dimmable **G** Item No. 8-205

Chrom Teile/
chrome parts
 Gepulverte Teile/
powder-coating

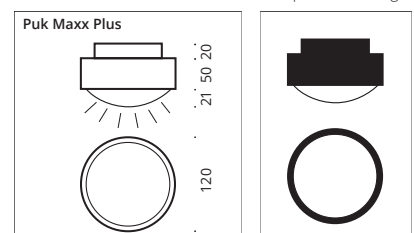

ABC (s.S 6-7/s.p. 6-7)





Puk Meg Maxx Plus ø 160

Deckenleuchte, Hochvolt LED Power oder Hochvolt Halogen, dimmbar.

Ceiling lamp, high voltage LED power or high voltage halogen, dimmable.

INDOOR



chrome

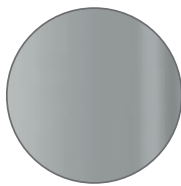

chrome matt

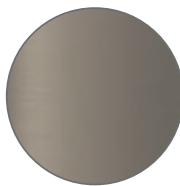

nickel matt

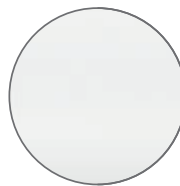

white matt

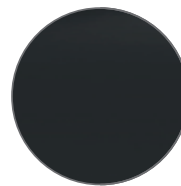

black matt

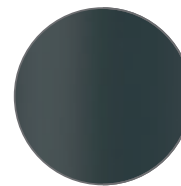

anthracite matt

Puk Meg Maxx Plus LED G 1 x 18W ~1.500lm, ~2.700k	Puk Meg Maxx Plus G9 Fassung	ø x Höhe ø x high in mm	Gehäuse body
● 2-402801	2-402801-H	160 x 80	chrome matt
● 2-402802	2-402802-H	160 x 80	chrome
● 2-402803	2-402803-H	160 x 80	nickel matt
● 2-402802-22	2-402802-H-22	160 x 80	white matt
● 2-402802-02	2-402802-H-02	160 x 80	black matt
● 2-402802-23	2-402802-H-23	160 x 80	anthracite matt

▶ Ohne Zubehör. Bestell-Artikelnummern für Linse, Glas, Farbfilter und die Konfigurationsempfehlung (2) auf der Einklappseite!



▶ Without accessories: Order item-no. for lens, glass, color filter and the recommended Configuration (2) are on the fold-in page!

💡 G9 max. 33W ECO, optional LED Retrofit
💡 G9 max. 33W ECO, LED Retrofit optional

💡 Leuchtmittelempfehlung: LED max. 3W/300lm/2.700K/dimmbar **G** Art. Nr. 8-205
💡 bulb recommendation: LED max. 3W/300Lm/2.700K/dimmable **G** Item No. 8-205

☐ Chrom Teile/
chrome parts
■ Gepulverte Teile/
powder-coating

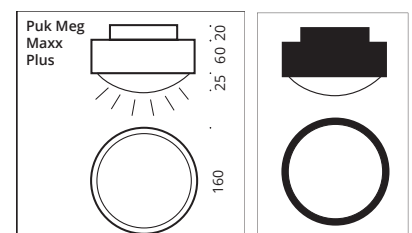





Puk Mini Turn \varnothing 80

Deckenleuchte, Hochvolt Halogen oder LED Power, dimmbar. Kopf dreh- und schwenkbar.

Ceiling lamp, high voltage halogen or LED power, dimmable. Head rotatable and titable.

INDOOR

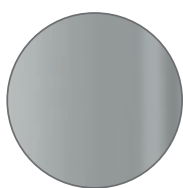

chrome matt



nickel matt

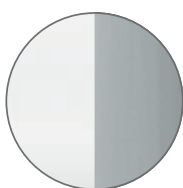

white matt/
chrome

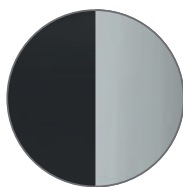

black matt/
chrome

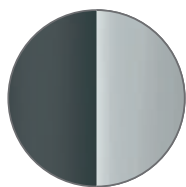

anthracite matt/
chrome

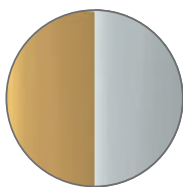

24c gold/
chrome



chrome

Puk Mini Turn LED ~1.200lm ~2.700k	Puk Mini Turn G9 Fassung	\varnothing x Höhe \varnothing x height in mm	Gehäuse body
up- & downlight 2 x 8W			
2-28001-LED	2-28001	80 x 120	chrome matt
2-28002-LED	2-28002	80 x 120	chrome
2-28003-LED	2-28003	80 x 120	nickel matt
2-28002-LED-22	2-28002-22	80 x 120	white matt/chrome
2-28002-LED-02	2-28002-02	80 x 120	black matt/chrome
2-28002-LED-23	2-28002-23	80 x 120	anthracite matt/chrome
2-28006-LED	2-28006	80 x 120	24 carat gold plated/chrome
downlight 1 x 8W			
2-38001-LED	2-38001	80 x 120	chrome matt
2-38002-LED	2-38002	80 x 120	chrome
2-38003-LED	2-38003	80 x 120	nickel matt
2-38002-LED-22	2-38002-22	80 x 120	white matt/chrome
2-38002-LED-02	2-38002-02	80 x 120	black matt/chrome
2-38002-LED-23	2-38002-23	80 x 120	anthracite matt/chrome
2-38006-LED	2-38006	80 x 120	24 carat gold plated/chrome

► Ohne Zubehör. Bestell-Artikelnummern für Linse, Glas, Farbfilter und die Konfigurationsempfehlung (2) auf der Einklappseite!

► Without accessories: Order item-no. for lens, glass, color filter and the recommended Configuration (2) are on the fold-in page!

G9 max. 33W ECO, optional LED Retrofit

G9 max. 33W ECO, LED Retrofit optional

Leuchtmittelempfehlung: LED max. 3W/300lm/2.700K/dimmbar Art. Nr. 8-205

bulb recommendation: LED max. 3W/300Lm/2.700K/dimmable Item No. 8-205



Chrom Teile/
chrome parts
 Gepulverte Teile/
powder-coating

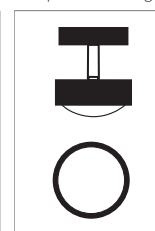
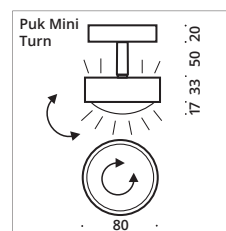





Puk Maxx Turn ø 120

Deckenleuchte, Hochvolt Halogen oder LED Power, dimmbar, Kopf dreh- und schwenkbar.

Ceiling lamp, high voltage halogen or LED power, dimmable, head rotatable and titable.

INDOOR

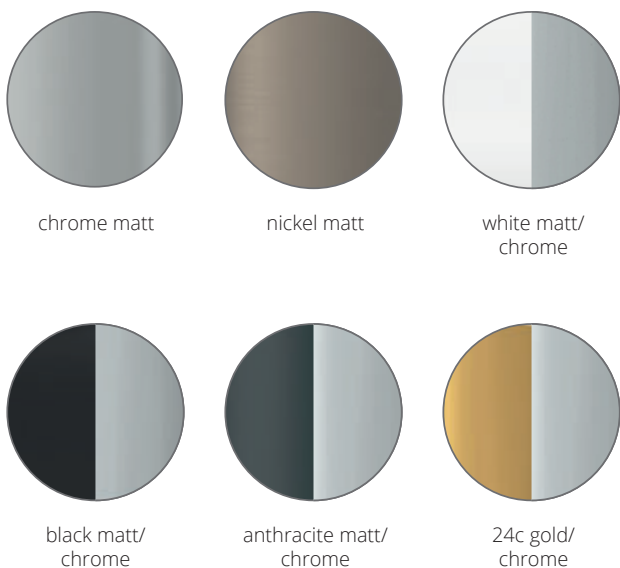

chrome

Puk Maxx Turn LED downlight	Puk Maxx Turn LED up-/downlight	Puk Maxx Turn G9 Fassung downlight	Puk Maxx Turn G9 Fassung up-/downlight	ø x Höhe mm ø x height mm	Gehäuse body
G 1 x 12W ~900lm ~2.700k	G 2 x 12W ~1.800lm ~2.700k				
● 2-3028001	2-3038001	2-3028001-H	2-3038001-H	120 x 141	chrome matt
● 2-3028002	2-3038002	2-3028002-H	2-3038002-H	120 x 141	chrome
● 2-3028003	2-3038003	2-3028003-H	2-3038003-H	120 x 141	nickel matt
● 2-3028002-22	2-3038002-22	2-3028002-H-22	2-3038002-H-22	120 x 141	white matt/chrome
● 2-3028002-02	2-3038002-02	2-3028002-H-02	2-3038002-H-02	120 x 141	black matt/chrome
● 2-3028002-23	2-3038002-23	2-3028002-H-23	2-3038002-H-23	120 x 141	anthracite matt/chr.
● 2-3028006	2-3038006	2-3028006-H	2-3038006-H	120 x 141	24 ct gold plated/chr.

□ Chrom Teile/
chrome parts
■ Gepulverte Teile/
powder-coating

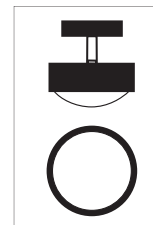

► Ohne Zubehör. Bestell-Artikelnummern für Linse, Glas, Farbfilter und die Konfigurationsempfehlung (2) auf der Einklappseite!



► Without accessories: Order item-no. for lens, glass, color filter and the recommended Configuration (2) are on the fold-in page!

💡 G9 max. 33W ECO, optional LED Retrofit
💡 G9 max. 33W ECO, LED Retrofit optional

💡 Leuchtmittelempfehlung: LED max. 3W/300lm/2.700K/dimmbar **G** Art. Nr. 8-205
💡 bulb recommendation: LED max. 3W/300Lm/2.700K/dimmable **G** Item No. 8-205

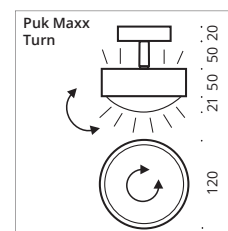





Puk Mini Move \varnothing 80

Deckenleuchte, Hochvolt LED Power oder Hochvolt Halogen, dimmbar. Dreh- (360°) und schwenkbare (\approx 50°) Deckenleuchte.

Ceiling lamp, high voltage LED power or high voltage halogen, dimmable. Rotating (360°) and titable (\approx 50°) ceiling lamp.

INDOOR

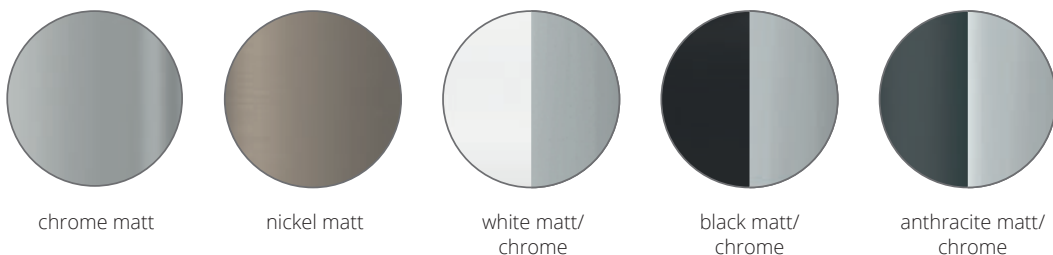
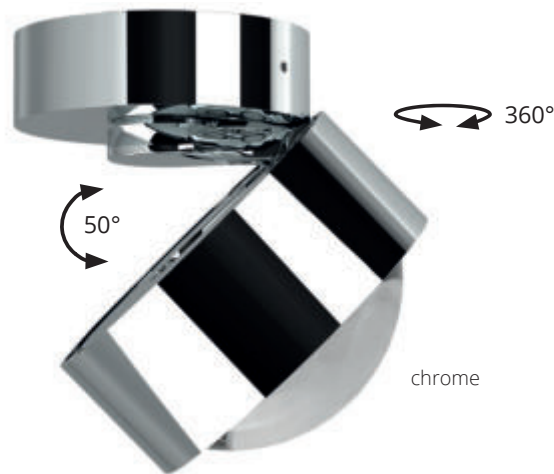

Puk Mini Move LED G 8W, ~600lm ~2.700k	Puk Mini Move G9 Fassung	\varnothing x Höhe \varnothing x height in mm	Gehäuse body
7-69001	7-69001-H	80 x 53	chrome matt
7-69002	7-69002-H	80 x 53	chrome
7-69003	7-69003-H	80 x 53	nickel matt
7-69002-22	7-69002-H-22	80 x 53	white matt/chrome
7-69002-02	7-69002-H-02	80 x 53	black matt/chrome
7-69002-23	7-69002-H-23	80 x 53	anthracite matt/chrome

► Ohne Zubehör. Bestell-Artikelnummern für Linse, Glas, Farbfilter und die Konfigurationsempfehlung (2) auf der Einklappseite!

► Without accessories: Order item-no. for lens, glass, color filter and the recommended Configuration (2) are on the fold-in page!

G9 max. 3W LED Retrofit
 G9 max. 3W Retrofit optional

Leuchtmittelempfehlung: LED max. 3W/300lm/2.700K/dimmbar **G** Art. Nr. 8-205
 bulb recommendation: LED max. 3W/300Lm/2.700K/dimmable **G** Item No. 8-205



Chrom Teile/
chrome parts
 Gepulverte Teile/
powder-coating

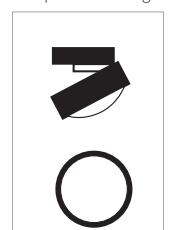
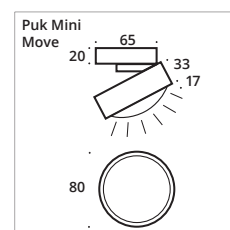





Puk Maxx Move ø 120

Deckenleuchte, Hochvolt LED Power oder Hochvolt Halogen, dimmbar. Dreh- (360°) und schwenkbare (± 106°) Deckenleuchte.

Ceiling lamp, high voltage LED power or high voltage halogen, dimmable. Rotating (360°) and titable (±106°) ceiling lamp.

INDOOR

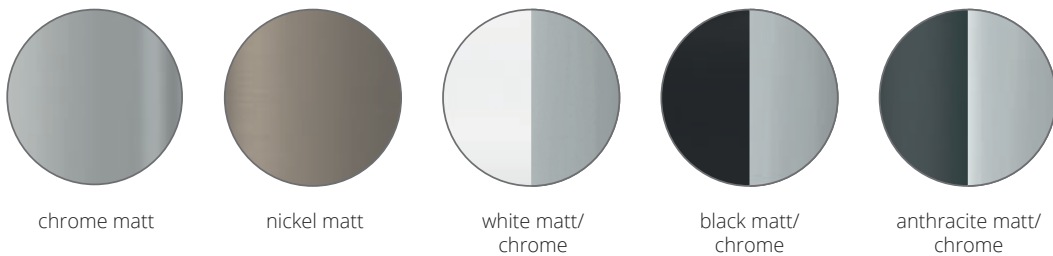

Puk Maxx Move LED G 12W, ~900lm ~2.700k	Puk Maxx Move G9 Fassung	ø x Höhe ø x height in mm	Gehäuse body
7-69301	7-69301-H	120 x 70	chrome matt
7-69302	7-69302-H	120 x 70	chrome
7-69303	7-69303-H	120 x 70	nickel matt
7-69302-22	7-69302-H-22	120 x 70	white matt/chrome
7-69302-02	7-69302-H-02	120 x 70	black matt/chrome
7-69302-23	7-69302-H-23	120 x 70	anthracite matt/chrome

► Ohne Zubehör. Bestell-Artikelnummern für Linse, Glas, Farbfilter und die Konfigurationsempfehlung (2) auf der Einklappseite!

► Without accessories: Order item-no. for lens, glass, color filter and the recommended Configuration (2) are on the fold-in page!

G9 max. 5W LED Retrofit
 G9 max. 5W Retrofit optional

Leuchtmittelempfehlung: LED max. 3W/300lm/2.700K/dimmbar **G** Art. Nr. 8-205
 bulb recommendation: LED max. 3W/300Lm/2.700K/dimmable **G** Item No. 8-205



Chrom Teile/
chrome parts
 Gepulverte Teile/
powder-coating

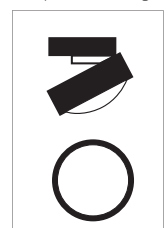
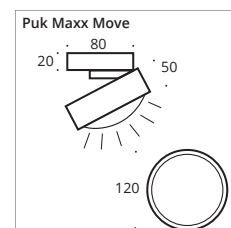





Puk Mini Eye Ceiling \varnothing 80 up & downlight

Deckenleuchte, Hochvolt LED Power oder Hochvolt Halogen, dimmbar. Smarte Deckenleuchte mit fest installierter Linse »up« und optionaler Linse oder Glas »down«.

Ceiling lamp, high voltage LED power or high voltage halogen, dimmable. Smart ceiling lamp with permanently installed "up" lens and optional "down" lens or glass.

INDOOR

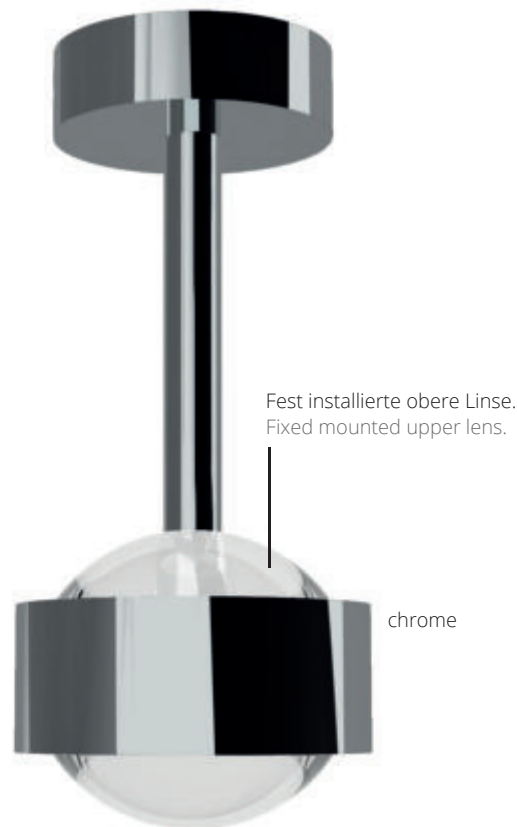
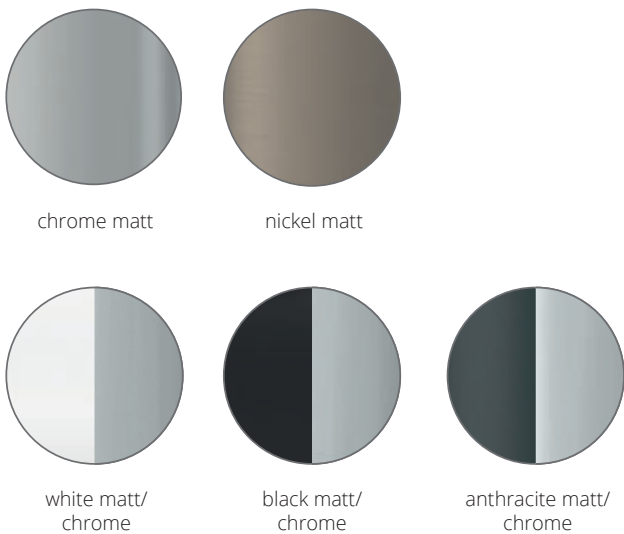

Fest installierte obere Linse.
Fixed mounted upper lens.

chrome

Puk Eye Ceiling LED G 2 x 8W, ~600lm ~2.700k	Puk Eye Ceiling G9 Fassung	\varnothing x Höhe \varnothing x height in mm	Gehäuse body
7-75001	7-75001-H	80 x 170	chrome matt
7-75002	7-75002-H	80 x 170	chrome
7-75003	7-75003-H	80 x 170	nickel matt
7-75002-22	7-75002-H-22	80 x 170	white matt/chr.
7-75002-02	7-75002-H-02	80 x 170	black matt/chr.
7-75002-23	7-75002-H-23	80 x 170	anthracite matt/chr.

► Ohne Zubehör. Bestell-Artikelnummern für Linse, Glas, Farbfilter und die Konfigurationsempfehlung (2) auf der Einklappseite!

► Without accessories: Order item-no. for lens, glass, color filter and the recommended Configuration (2) are on the fold-in page!

G9 max. 33W ECO, optional LED Retrofit
 G9 max. 33W ECO, LED Retrofit optional

Leuchtmittelempfehlung: LED max. 3W/300lm/2.700K/dimmbar **G** Art. Nr. 8-205
 bulb recommendation: LED max. 3W/300Lm/2.700K/dimmable **G** Item No. 8-205

Chrom Teile/
chrome parts
 Gepulverte Teile/
powder-coating

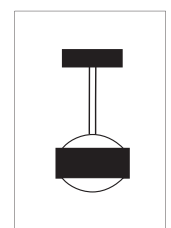
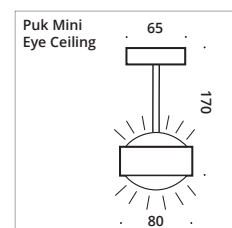





Puk Maxx Eye Ceiling \varnothing 120 up & downlight

Deckenleuchte, Hochvolt LED Power oder Hochvolt Halogen, dimmbar. Smarte Deckenleuchte mit fest installierter Linse »up« und optionaler Linse oder Glas »down«.

Ceiling lamp, high voltage LED power or high voltage halogen, dimmable. Smart ceiling lamp with permanently installed "up" lens and optional "down" lens or glass.

INDOOR

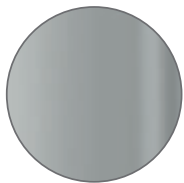

chrome matt



nickel matt

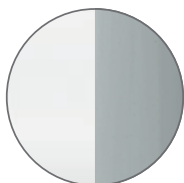

white matt/
chrome

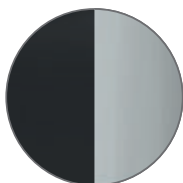

black matt/
chrome



anthracite matt/
chrome

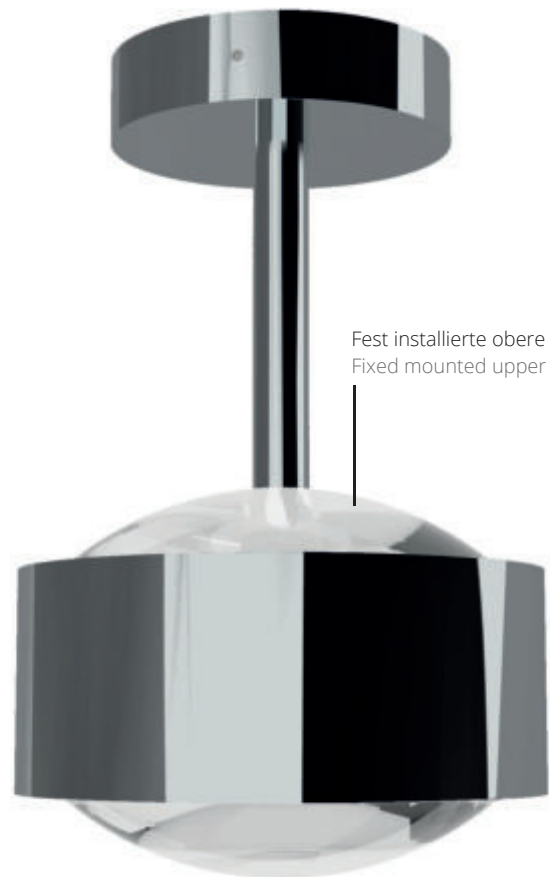

chrome

Fest installierte obere Linse.
Fixed mounted upper lens.

Puk Maxx Eye Ceiling LED G 2 x 12W, ~1.800lm ~2.700k	Puk Maxx Eye Ceiling G9 Fassung	\varnothing x Höhe \varnothing x height in mm	Gehäuse body
7-753001	7-753001-H	120 x 185	chrome matt
7-753002	7-753002-H	120 x 185	chrome
7-753003	7-753003-H	120 x 185	nickel matt
7-753002-22	7-753002-H-22	120 x 185	white matt/chr.
7-753002-02	7-753002-H-02	120 x 185	black matt/chr.
7-753002-23	7-753002-H-23	120 x 185	anthracite matt/chr.

► Ohne Zubehör. Bestell-Artikelnummern für Linse, Glas, Farbfilter und die Konfigurationsempfehlung (2) auf der Einklappseite!



► Without accessories: Order item-no. for lens, glass, color filter and the recommended Configuration (2) are on the fold-in page!

G9 max. 33W ECO, optional LED Retrofit
 G9 max. 33W ECO, LED Retrofit optional

Leuchtmittelempfehlung: LED max. 3W/300lm/2.700K/dimmbar **G** Art. Nr. 8-205
 bulb recommendation: LED max. 3W/300Lm/2.700K/dimmable **G** Item No. 8-205



Chrom Teile/
chrome parts
 Gepulverte Teile/
powder-coating

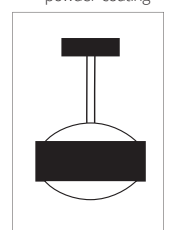
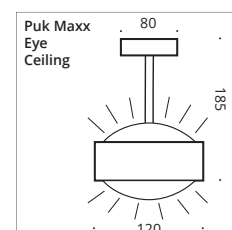





Puk Meg Maxx Eye Ceiling \varnothing 160 up & downlight

Deckenleuchte, Hochvolt LED Power oder Hochvolt Halogen, dimmbar. Smarte Deckenleuchte mit fest installierter Linse »up« und optionaler Linse oder Glas »down«.

Ceiling lamp, high voltage LED power or high voltage halogen, dimmable. Smart ceiling lamp with permanently installed "up" lens and optional "down" lens or glass.

INDOOR

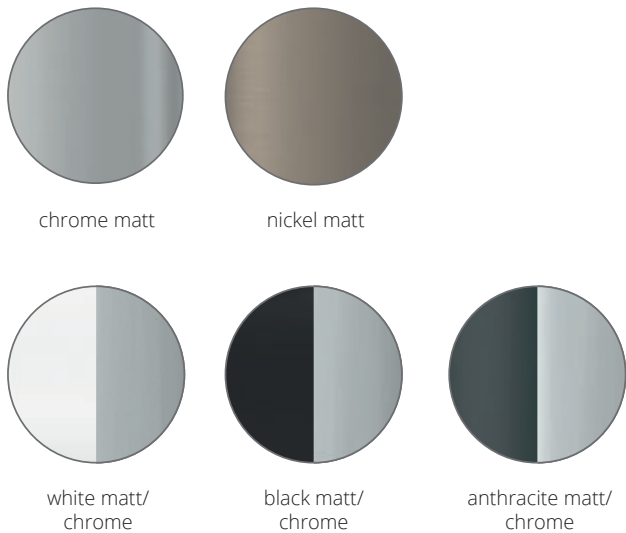

Puk Meg Maxx Eye Ceiling LED G 2 x 16W ~2.400lm ~2.700k	Puk Meg Maxx Eye Ceiling G9 Fassung	\varnothing x Höhe \varnothing x height in mm	Gehäuse body
7-755001	7-755001-H	160 x 210	chrome matt
7-755002	7-755002-H	160 x 210	chrome
7-755003	7-755003-H	160 x 210	nickel matt
7-755002-22	7-755002-H-22	160 x 210	white matt/chr.
7-755002-02	7-755002-H-02	160 x 210	black matt/chr.
7-755002-23	7-755002-H-23	160 x 210	anthracite matt/chr.

► Ohne Zubehör. Bestell-Artikelnummern für Linse, Glas, Farbfilter und die Konfigurationsempfehlung (2) auf der Einklappseite!

► Without accessories: Order item-no. for lens, glass, color filter and the recommended Configuration (2) are on the fold-in page!

G9 max. 33W ECO, optional LED Retrofit

G9 max. 33W ECO, LED Retrofit optional

Leuchtmittelempfehlung: LED max. 3W/300lm/2.700K/dimmbar **G** Art. Nr. 8-205

bulb recommendation: LED max. 3W/300Lm/2.700K/dimmable **G** Item No. 8-205



Chrom Teile/
chrome parts

Gepulverte Teile/
powder-coating

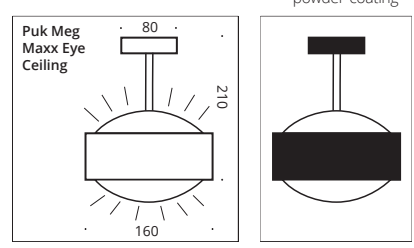

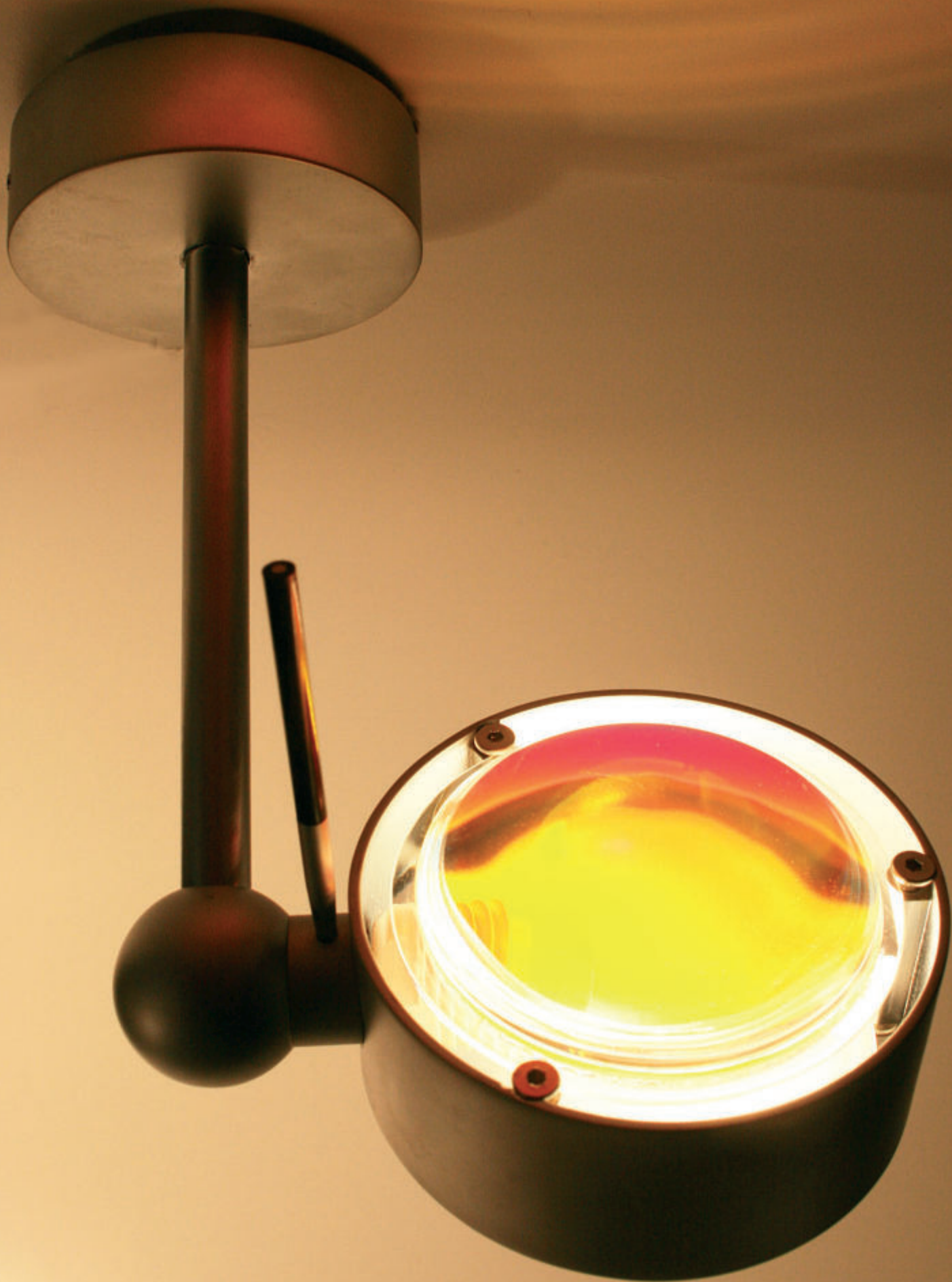

Puk Mini Side Single



Puk Mini Side Single ø 80

Deckenleuchte, Hochvolt Halogen oder LED Power, dimmbar, Kopf drehbar mit Verstellstift. Mit drehbarem Arm (bis 350°).

Ceiling lamp, high voltage halogen or LED power, dimmable, head rotatable with adjusting pin. With turnable arm (up to 350°).

INDOOR

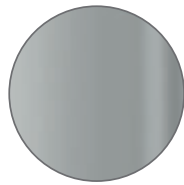

chrome matt

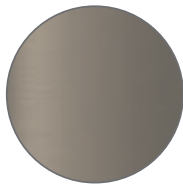

nickel matt

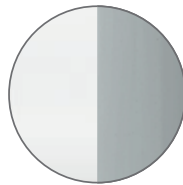

white matt/
chrome

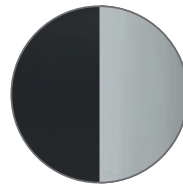

black matt/
chrome

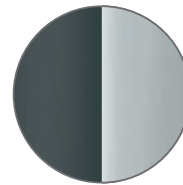

anthracite matt/
chrome

Puk Side Single LED G 2 x 8W ~1.200lm ~2.700k	Puk Side Single G9 Fassung L	Armlänge arm length in mm	Gehäuse body
2-0821-LED	2-0821	100	chrome matt
2-0822-LED	2-0822	100	chrome
2-0823-LED	2-0823	100	nickel matt
2-0822-LED-22	2-0822-22	100	white matt/chr.
2-0822-LED-02	2-0822-02	100	black matt/chr.
2-0822-LED-23	2-0822-23	100	anthracite matt/chr.
2-0831-LED	2-0831	200	chrome matt
2-0832-LED	2-0832	200	chrome
2-0833-LED	2-0833	200	nickel matt
2-0832-LED-22	2-0832-22	200	white matt/chr.
2-0832-LED-02	2-0832-02	200	black matt/chr.
2-0832-LED-23	2-0832-23	200	anthracite matt/chr.
2-0861-LED	2-0861	300	chrome matt
2-08062-LED	2-08062	300	chrome
2-0863-LED	2-0863	300	nickel matt
2-08062-LED-22	2-08062-22	300	white matt/chr.
2-08062-LED-02	2-08062-02	300	black matt/chr.
2-08062-LED-23	2-08062-23	300	anthracite matt/chr.
2-0871-LED	2-0871	400	chrome matt
2-0872-LED	2-0872	400	chrome
2-0873-LED	2-0873	400	nickel matt
2-0872-LED-22	2-0872-22	400	white matt/chr.
2-0872-LED-02	2-0872-02	400	black matt/chr.
2-0872-LED-23	2-0872-23	400	anthracite matt/chr.
2-0881-LED	2-0881	600	chrome matt
2-0882-LED	2-0882	600	chrome
2-0883-LED	2-0883	600	nickel matt
2-0882-LED-22	2-0882-22	600	white matt/chr.
2-0882-LED-02	2-0882-02	600	black matt/chr.
2-0882-LED-23	2-0882-23	600	anthracite matt/chr.

▶ Ohne Zubehör. Bestell-Artikelnummern für Linse, Glas, Farbfilter und die Konfigurationsempfehlung (2) auf der Einklappseite!



▶ Without accessories: Order item-no. for lens, glass, color filter and the recommended Configuration (2) are on the fold-in page!

L G9 max. 33W ECO, optional LED Retrofit
L G9 max. 33W ECO, LED Retrofit optional

L Leuchtmittelempfehlung: LED max. 3W/300lm/2.700K/dimmbar **G** Art. Nr. 8-205
L bulb recommendation: LED max. 3W/300Lm/2.700K/dimmable **G** Item No. 8-205



chrome

□ Chrom Teile/
chrome parts
■ Gepulverte Teile/
powder-coating

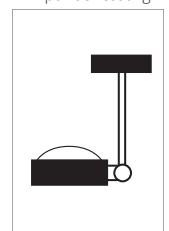
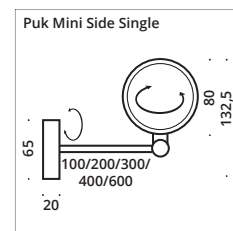



Puk Maxx Side Single



Puk Maxx Side Single ø 120

Deckenleuchte mit Arm, Hochvolt Halogen oder LED Power, Kopf drehbar. Mit drehbarem Arm (bis 350°).

Ceiling lamp with arm, high voltage halogen or LED power, head rotatable. With turnable arm (up to 350°).

INDOOR

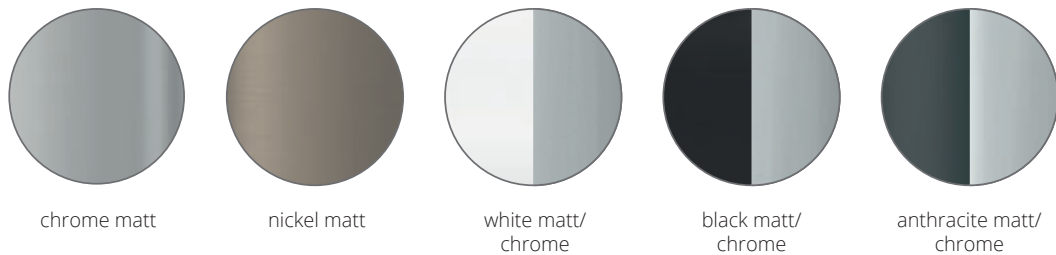

Puk Maxx Side Single LED 2 x 12W ~1.800lm ~2.700k	Puk Maxx Side Single G9 Fassung	Armlänge arm length in mm	Gehäuse body
2-30821	2-30821-H	100	chrome matt
2-30822	2-30822-H	100	chrome
2-30823	2-30823-H	100	nickel matt
2-30822-22	2-30822-H-22	100	white matt/chr.
2-30822-02	2-30822-H-02	100	black matt/chr.
2-30822-23	2-30822-H-23	100	anthracite matt/chr.
2-30831	2-30831-H	200	chrome matt
2-30832	2-30832-H	200	chrome
2-30833	2-30833-H	200	nickel matt
2-30832-22	2-30832-H-22	200	white matt/chr.
2-30832-02	2-30832-H-02	200	black matt/chr.
2-30832-23	2-30832-H-23	200	anthracite matt/chr.
2-30861	2-30861-H	300	chrome matt
2-30862	2-30862-H	300	chrome
2-30863	2-30863-H	300	nickel matt
2-30862-22	2-30862-H-22	300	white matt/chr.
2-30862-02	2-30862-H-02	300	black matt/chr.
2-30862-23	2-30862-H-23	300	anthracite matt/chr.
2-30871	2-30871-H	400	chrome matt
2-30872	2-30872-H	400	chrome
2-30873	2-30873-H	400	nickel matt
2-30872-22	2-30872-H-22	400	white matt/chr.
2-30872-02	2-30872-H-02	400	black matt/chr.
2-30872-23	2-30872-H-23	400	anthracite matt/chr.
2-30881	2-30881-H	600	chrome matt
2-30882	2-30882-H	600	chrome
2-30883	2-30883-H	600	nickel matt
2-30882-22	2-30882-H-22	600	white matt/chr.
2-30882-02	2-30882-H-02	600	black matt/chr.
2-30882-23	2-30882-H-23	600	anthracite matt/chr.



chrome

► Ohne Zubehör. Bestell-Artikelnummern für Linse, Glas, Farbfilter und die Konfigurationsempfehlung (2) auf der Einklappseite!



► Without accessories: Order item-no. for lens, glass, color filter and the recommended Configuration (2) are on the fold-in page!

G9 max. 33W ECO, optional LED Retrofit
 G9 max. 33W ECO, LED Retrofit optional

Leuchtmittelempfehlung: LED max. 3W/300lm/2.700K/dimmbar Art. Nr. 8-205
 bulb recommendation: LED max. 3W/300Lm/2.700K/dimmable Item No. 8-205



Chrom Teile/
chrome parts
 Gepulverte Teile/
powder-coating

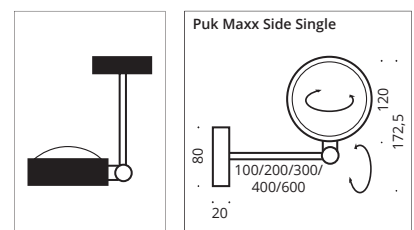





Puk Mini Side Twin \varnothing 80

Deckenleuchte, Hochvolt Halogen oder LED Power, dimmbar, Köpfe drehbar mit Verstellstift. Mit drehbarem Arm (bis 350°).

Ceiling lamp, high voltage halogen or LED power, dimmable, heads rotatable with adjusting pin. With rotatable arm (up to 350°).

INDOOR

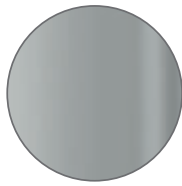

chrome matt

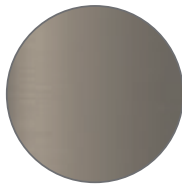

nickel matt

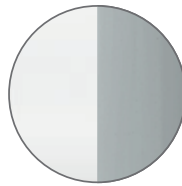

white matt/
chrome

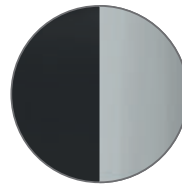

black matt/
chrome

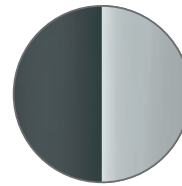

anthracite matt/
chrome

Puk Side Twin LED G 4 x 8W ~2.400lm ~2.700k	Puk Side Twin G9 Fassung G	Armlänge arm length in mm	Gehäuse body
● 2-0841-LED	2-0841	100	chrome matt
● 2-0842-LED	2-0842	100	chrome
● 2-0843-LED	2-0843	100	nickel matt
● 2-0842-LED-22	2-0842-22	100	white matt/chr.
● 2-0842-LED-02	2-0842-02	100	black matt/chr.
● 2-0842-LED-23	2-0842-23	100	anthracite matt/chr.
● 2-0851-LED	2-0851	200	chrome matt
● 2-0852-LED	2-0852	200	chrome
● 2-0853-LED	2-0853	200	nickel matt
● 2-0852-LED-22	2-0852-22	200	white matt/chr.
● 2-0852-LED-02	2-0852-02	200	black matt/chr.
● 2-0852-LED-23	2-0852-23	200	anthracite matt/chr.
● 2-0891-LED	2-0891	300	chrome matt
● 2-0892-LED	2-0892	300	chrome
● 2-0893-LED	2-0893	300	nickel matt
● 2-0892-LED-22	2-0892-22	300	white matt/chr.
● 2-0892-LED-02	2-0892-02	300	black matt/chr.
● 2-0892-LED-23	2-0892-23	300	anthracite matt/chr.
● 2-08101-LED	2-08101	400	chrome matt
● 2-08102-LED	2-08102	400	chrome
● 2-08103-LED	2-08103	400	nickel matt
● 2-08102-LED-22	2-08102-22	400	white matt/chr.
● 2-08102-LED-02	2-08102-02	400	black matt/chr.
● 2-08102-LED-23	2-08102-23	400	anthracite matt/chr.
● 2-08111-LED	2-08111	600	chrome matt
● 2-08112-LED	2-08112	600	chrome
● 2-08113-LED	2-08113	600	nickel matt
● 2-08112-LED-22	2-08112-22	600	white matt/chr.
● 2-08112-LED-02	2-08112-02	600	black matt/chr.
● 2-08112-LED-23	2-08112-23	600	anthracite matt/chr.



chrome

- Chrom Teile/
chrome parts
- Gepulverte Teile/
powder-coating

▶ Ohne Zubehör. Bestell-Artikelnummern für Linse, Glas, Farbfilter und die Konfigurationsempfehlung (2) auf der Einklappseite!

▶ Without accessories: Order item-no. for lens, glass, color filter and the recommended Configuration (2) are on the fold-in page!

G9 max. 33W ECO, optional LED Retrofit
 G9 max. 33W ECO, LED Retrofit optional

Leuchtmittelempfehlung: LED max. 3W/300lm/2.700K/dimmbar **G** Art. Nr. 8-205
 bulb recommendation: LED max. 3W/300Lm/2.700K/dimmable **G** Item No. 8-205

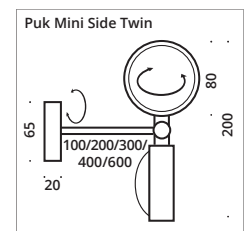
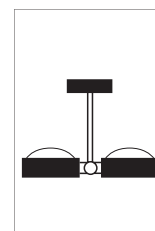





Puk Maxx Side Twin ø 120

Deckenleuchte mit Arm, Hochvolt Halogen oder LED Power, Köpfe drehbar. Mit drehbarem Arm (bis 350°).

Ceiling lamp with arm, high voltage halogen or LED power, heads rotatable. With rotatable arm (up to 350°).

INDOOR

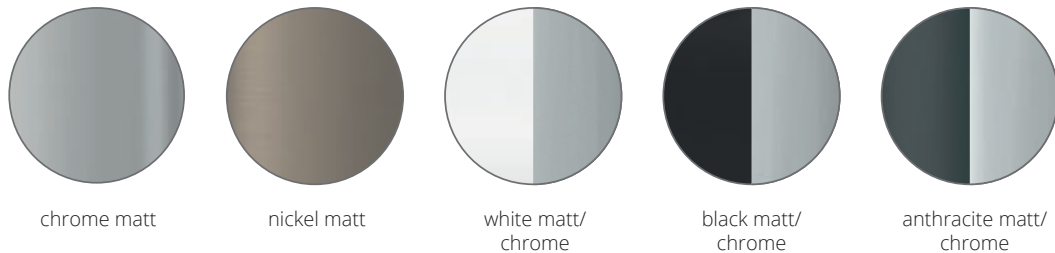

Puk Maxx Side Twin LED 4 x 12W ~3.600lm ~2.700k	Puk Maxx Side Twin G9 Fassung	Armlänge arm length in mm	Gehäuse body
2-30841	2-30841-H	100	chrome matt
2-30842	2-30842-H	100	chrome
2-30843	2-30843-H	100	nickel matt
2-30842-22	2-30842-H-22	100	white matt/chr.
2-30842-02	2-30842-H-02	100	black matt/chr.
2-30842-23	2-30842-H-23	100	anthracite matt/chr.
2-30851	2-30851-H	200	chrome matt
2-30852	2-30852-H	200	chrome
2-30853	2-30853-H	200	nickel matt
2-30852-22	2-30852-H-22	200	white matt/chr.
2-30852-02	2-30852-H-02	200	black matt/chr.
2-30852-23	2-30852-H-23	200	anthracite matt/chr.
2-30891	2-30891-H	300	chrome matt
2-30892	2-30892-H	300	chrome
2-30893	2-30893-H	300	nickel matt
2-30892-22	2-30892-H-22	300	white matt/chr.
2-30892-02	2-30892-H-02	300	black matt/chr.
2-30892-23	2-30892-H-23	300	anthracite matt/chr.
2-308101	2-308101-H	400	chrome matt
2-308102	2-308102-H	400	chrome
2-308103	2-308103-H	400	nickel matt
2-308102-22	2-308102-H-22	400	white matt/chr.
2-308102-02	2-308102-H-02	400	black matt/chr.
2-308102-23	2-308102-H-23	400	anthracite matt/chr.
2-308111	2-308111-H	600	chrome matt
2-308112	2-308112-H	600	chrome
2-308113	2-308113-H	600	nickel matt
2-308112-22	2-308112-H-22	600	white matt/chr.
2-308112-02	2-308112-H-02	600	black matt/chr.
2-308112-23	2-308112-H-23	600	anthracite matt/chr.



Chrom Teile/
chrome parts
 Gepulverte Teile/
powder-coating

► Ohne Zubehör. Bestell-Artikelnummern für Linse, Glas, Farbfilter und die Konfigurationsempfehlung (2) auf der Einklappseite!

► Without accessories: Order item-no. for lens, glass, color filter and the recommended Configuration (2) are on the fold-in page!

G9 max. 33W ECO, optional LED Retrofit
 G9 max. 33W ECO, LED Retrofit optional

Leuchtmittelpfehlung: LED max. 3W/300lm/2.700K/dimmbar Art. Nr. 8-205
 bulb recommendation: LED max. 3W/300Lm/2.700K/dimmable Item No. 8-205

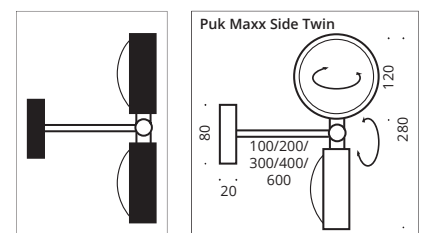





Puk Mini Wing Single \varnothing 80

Deckenleuchte, Hochvolt Halogen oder LED Power, dimmbar, Kopf drehbar mit Verstellstift, Arm schwenkbar.

Ceiling lamp, high voltage halogen or LED power, dimmable, head rotatable with adjusting pin, arm pivoting.

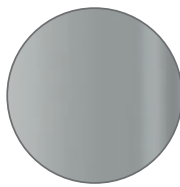

chrome matt

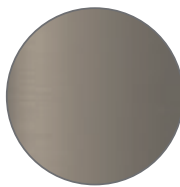

nickel matt



white matt/
chrome

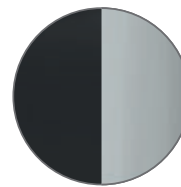

black matt/
chrome

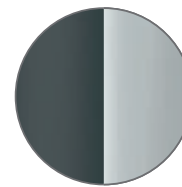

anthracite matt/
chrome

Puk Wing Single LED G 2 x 8W ~1.200lm ~2.700k	Puk Wing Single G9 Fassung	Armlänge arm length in mm	Gehäuse body
2-08201-LED	2-08201	200	chrome matt
2-08202-LED	2-08202	200	chrome
2-08203-LED	2-08203	200	nickel matt
2-08202-LED-22	2-08202-22	200	white/chrome
2-08202-LED-02	2-08202-02	200	black/chrome
2-08202-LED-23	2-08202-23	200	anthracite matt/chr.
2-08301-LED	2-08301	300	chrome matt
2-08302-LED	2-08302	300	chrome
2-08303-LED	2-08303	300	nickel matt
2-08302-LED-22	2-08302-22	300	white/chrome
2-08302-LED-02	2-08302-02	300	black/chrome
2-08302-LED-23	2-08302-23	300	anthracite matt/chr.
2-08401-LED	2-08401	400	chrome matt
2-08402-LED	2-08402	400	chrome
2-08403-LED	2-08403	400	nickel matt
2-08402-LED-22	2-08402-22	400	white/chrome
2-08402-LED-02	2-08402-02	400	black/chrome
2-08402-LED	2-08402-23	400	anthracite matt/chr.
2-08601-LED	2-08601	600	chrome matt
2-08602-LED	2-08602	600	chrome
2-08603-LED	2-08603	600	nickel matt
2-08602-LED-22	2-08602-22	600	white/chrome
2-08602-LED-02	2-08602-02	600	black/chrome
2-08602-LED-23	2-08602-23	600	anthracite matt/chr.
2-08801-LED	2-08801	800	chrome matt
2-08802-LED	2-08802	800	chrome
2-08803-LED	2-08803	800	nickel matt
2-08802-LED-22	2-08802-22	800	white/chrome
2-08802-LED-02	2-08802-02	800	black/chrome
2-08802-LED-23	2-08802-23	800	anthracite matt/chr.
2-081001-LED	2-081001	1.000	chrome matt
2-081002-LED	2-081002	1.000	chrome
2-081003-LED	2-081003	1.000	nickel matt
2-081002-LED-22	2-081002-22	1.000	white/chrome
2-081002-LED-02	2-081002-02	1.000	black/chrome
2-081002-LED-23	2-081002-23	1.000	anthracite matt/chr.
2-081201-LED	2-081201	1.250	chrome matt
2-081202-LED	2-081202	1.250	chrome
2-081203-LED	2-081203	1.250	nickel matt
2-081202-LED-22	2-081202-22	1.250	white/chrome
2-081202-LED-02	2-081202-02	1.250	black/chrome
2-081202-LED-23	2-081202-23	1.250	anthracite matt/chr.



chrome

Gepulverteile / powder-coating

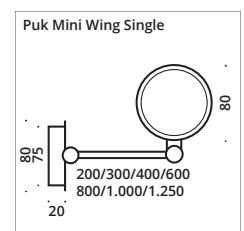
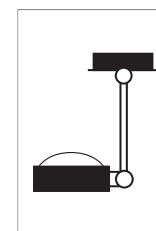

▶ Ohne Zubehör. Bestell-Artikelnummern für Linse, Glas, Farbfilter und die Konfigurationsempfehlung (2) auf der Einklappseite!



▶ Without accessories: Order item-no. for lens, glass, color filter and the recommended Configuration (2) are on the fold-in page!

G9 max. 33W ECO, optional LED Retrofit
 G9 max. 33W ECO, LED Retrofit optional

Leuchtmittelempfehlung: LED max. 3W/300lm/2.700K/dimmbar **G** Art. Nr. 8-205
 bulb recommendation: LED max. 3W/300Lm/2.700K/dimmable **G** Item No. 8-205



BC (s.S 6-7/s.p. 6-7)





Puk Maxx Wing Single ø 120

Deckenleuchte mit schwenkbarem Arm, Hochvolt Halogen oder LED Power, Kopf drehbar.

Ceiling lamp with adjustable arm, high voltage halogen or LED power, head rotatable.

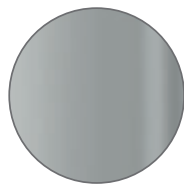

chrome matt



nickel matt

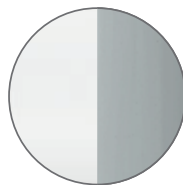

white matt/
chrome

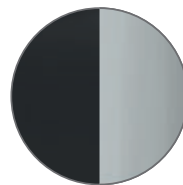

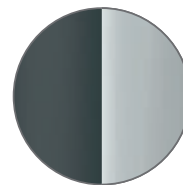

black matt/
chrome





anthracite matt/
chrome

INDOOR

Puk Maxx Wing Single LED 	Puk Maxx Wing Single G9 Fassung 	Armlänge arm length in mm	Gehäuse body
● 2-38201	2-38201-H	200	chrome matt
● 2-38202	2-38202-H	200	chrome
● 2-38203	2-38203-H	200	nickel matt
● 2-38202-22	2-38202-H-22	200	white matt/chr.
● 2-38202-02	2-38202-H-02	200	black matt/chr.
● 2-38202-23	2-38202-H-23	200	anthracite matt/chr.
● 2-38301	2-38301-H	300	chrome matt
● 2-38302	2-38302-H	300	chrome
● 2-38303	2-38303-H	300	nickel matt
● 2-38302-22	2-38302-H-22	300	white matt/chr.
● 2-38302-02	2-38302-H-02	300	black matt/chr.
● 2-38302-23	2-38302-H-23	300	anthracite matt/chr.
● 2-38401	2-38401-H	400	chrome matt
● 2-38402	2-38402-H	400	chrome
● 2-38403	2-38403-H	400	nickel matt
● 2-38402-22	2-38402-H-22	400	white matt/chr.
● 2-38402-02	2-38402-H-02	400	black matt/chr.
● 2-38402-23	2-38402-H-23	400	anthracite matt/chr.
● 2-38601	2-38601-H	600	chrome matt
● 2-38602	2-38602-H	600	chrome
● 2-38603	2-38603-H	600	nickel matt
● 2-38602-22	2-38602-H-22	600	white matt/chr.
● 2-38602-02	2-38602-H-02	600	black matt/chr.
● 2-38602-23	2-38602-H-23	600	anthracite matt/chr.
● 2-38801	2-38801-H	800	chrome matt
● 2-38802	2-38802-H	800	chrome
● 2-38803	2-38803-H	800	nickel matt
● 2-38802-22	2-38802-H-22	800	white matt/chr.
● 2-38802-02	2-38802-H-02	800	black matt/chr.
● 2-38802-23	2-38802-H-23	800	anthracite matt/chr.
● 2-381001	2-381001-H	1.000	chrome matt
● 2-381002	2-381002-H	1.000	chrome
● 2-381003	2-381003-H	1.000	nickel matt
● 2-381002-22	2-381002-H-22	1.000	white matt/chr.
● 2-381002-02	2-381002-H-02	1.000	black matt/chr.
● 2-381002-23	2-381002-H-23	1.000	anthracite matt/chr.
● 2-381201	2-381201-H	1.250	chrome matt
● 2-381202	2-381202-H	1.250	chrome
● 2-381203	2-381203-H	1.250	nickel matt
● 2-381202-22	2-381202-H-22	1.250	white matt/chr.
● 2-381202-02	2-381202-H-02	1.250	black matt/chr.
● 2-381202-23	2-381202-H-23	1.250	anthracite matt/chr.



chrome

-  Chrom Teile/
chrome parts
-  Gepulverte Teile/
powder-coating

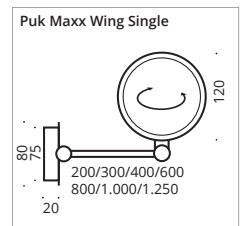
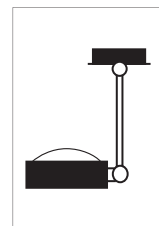

- ▶ Ohne Zubehör. Bestell-Artikelnummern für Linse, Glas, Farbfilter und die Konfigurationsempfehlung (2) auf der Einklappseite! 
- ▶ Without accessories: Order item-no. for lens, glass, color filter and the recommended Configuration (2) are on the fold-in page!

 G9 max. 33W ECO, optional LED Retrofit
G9 max. 33W ECO, LED Retrofit optional

 Leuchtmittelempfehlung: LED max. 3W/300lm/2.700K/dimmbar  Art. Nr. 8-205
bulb recommendation: LED max. 3W/300lm/2.700K/dimmable  Item No. 8-205



 BC (s.S 6-7/s.p. 6-7)





Puk Mini Wing Twin ø 80

Deckenleuchte, Hochvolt Halogen oder LED Power, dimmbar, Köpfe drehbar mit Verstellstift, Arm schwenkbar.

Ceiling lamp, high voltage halogen or LED power, dimmable, heads rotatable with adjusting pin, arm pivoting.

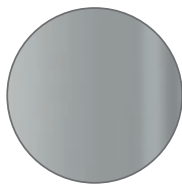

chrome matt

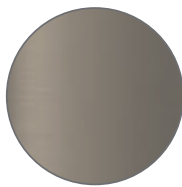

nickel matt

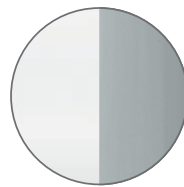

white matt/
chrome

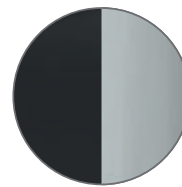

black matt/
chrome

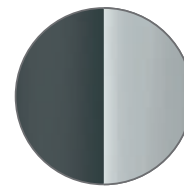

anthracite matt/
chrome

Puk Wing Twin LED G 4 x 8W ~2.400lm ~2.700k	Puk Wing Twin G9 Fassung	Armlänge arm length in mm	Gehäuse body
● 2-09201-LED	2-09201	200	chrome matt
● 2-09202-LED	2-09202	200	chrome
● 2-09203-LED	2-09203	200	nickel matt
● 2-09202-LED-22	2-09202-22	200	white matt/chr.
● 2-09202-LED-02	2-09202-02	200	black matt/chr.
● 2-09202-LED-23	2-09202-23	200	anthracite matt/chr.
● 2-09301-LED	2-09301	300	chrome matt
● 2-09302-LED	2-09302	300	chrome
● 2-09303-LED	2-09303	300	nickel matt
● 2-09302-LED-22	2-09302-22	300	white matt/chr.
● 2-09302-LED-02	2-09302-02	300	black matt/chr.
● 2-09302-LED-23	2-09302-23	300	anthracite matt/chr.
● 2-09401-LED	2-09401	400	chrome matt
● 2-09402-LED	2-09402	400	chrome
● 2-09403-LED	2-09403	400	nickel matt
● 2-09402-LED-22	2-09402-22	400	white matt/chr.
● 2-09402-LED-02	2-09402-02	400	black matt/chr.
● 2-09402-LED-23	2-09402-23	400	anthracite matt/chr.
● 2-09601-LED	2-09601	600	chrome matt
● 2-09602-LED	2-09602	600	chrome
● 2-09603-LED	2-09603	600	nickel matt
● 2-09602-LED-22	2-09602-22	600	white matt/chr.
● 2-09602-LED-02	2-09602-02	600	black matt/chr.
● 2-09602-LED-23	2-09602-23	600	anthracite matt/chr.
● 2-09801-LED	2-09801	800	chrome matt
● 2-09802-LED	2-09802	800	chrome
● 2-09803-LED	2-09803	800	nickel matt
● 2-09802-LED-22	2-09802-22	800	white matt/chr.
● 2-09802-LED-02	2-09802-02	800	black matt/chr.
● 2-09802-LED-23	2-09802-23	800	anthracite matt/chr.
● 2-091001-LED	2-091001	1.000	chrome matt
● 2-091002-LED	2-091002	1.000	chrome
● 2-091003-LED	2-091003	1.000	nickel matt
● 2-091002-LED-22	2-091002-22	1.000	white matt/chr.
● 2-091002-LED-02	2-091002-02	1.000	black matt/chr.
● 2-091002-LED-23	2-091002-23	1.000	anthracite matt/chr.
● 2-091201-LED	2-091201	1.250	chrome matt
● 2-091202-LED	2-091202	1.250	chrome
● 2-091203-LED	2-091203	1.250	nickel matt
● 2-091202-LED-22	2-091202-22	1.250	white matt/chr.
● 2-091202-LED-02	2-091202-02	1.250	black matt/chr.
● 2-091202-LED-23	2-091202-23	1.250	anthracite matt/chr.

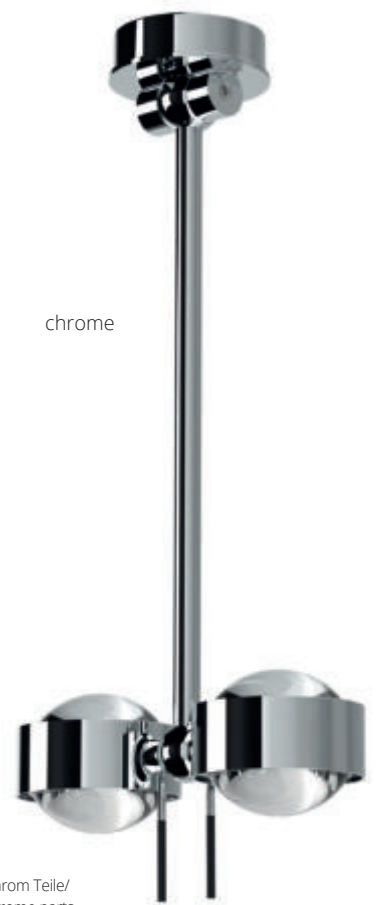

chrome

- Chrom Teile/
chrome parts
- Gepulverte Teile/
powder-coating

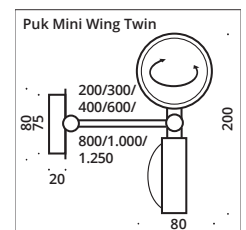
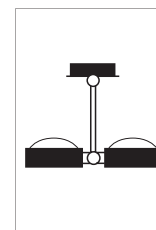

▶ Ohne Zubehör. Bestell-Artikelnummern für Linse, Glas, Farbfilter und die Konfigurationsempfehlung (2) auf der Einklappseite!



▶ Without accessories: Order item-no. for lens, glass, color filter and the recommended Configuration (2) are on the fold-in page!

G9 max. 33W ECO, optional LED Retrofit
 G9 max. 33W ECO, LED Retrofit optional

Leuchtmittelempfehlung: LED max. 3W/300lm/2.700K/dimmbar **G** Art. Nr. 8-205
 bulb recommendation: LED max. 3W/300lm/2.700K/dimmable **G** Item No. 8-205



BC (s.S 6-7/s.p. 6-7)



Puk Maxx Wing Twin



Puk Maxx Wing Twin ø 120

Deckenleuchte mit schwenkbarem Arm, Hochvolt Halogen oder LED Power, Köpfe drehbar.

Ceiling lamp with adjustable arm, high voltage halogen or LED power, heads rotatable.

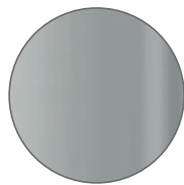

chrome matt



nickel matt

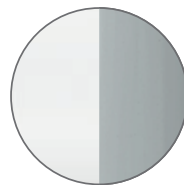

white matt/
chrome

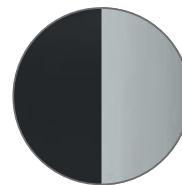

black matt/
chrome

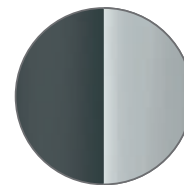

anthracite matt/
chrome

Puk Maxx Wing Twin LED 4 x 12W ~3.600lm ~2.700k	Puk Maxx Wing Twin G9 Fassung	Armlänge arm length in mm	Gehäuse body
● 2-39201	2-39201-H	200	chrome matt
● 2-39202	2-39202-H	200	chrome
● 2-39203	2-39203-H	200	nickel matt
● 2-39202-22	2-39202-H-22	200	white matt/chr.
● 2-39202-02	2-39202-H-02	200	black matt/chr.
● 2-39202-23	2-39202-H-23	200	anthracite matt/chr.
● 2-39301	2-39301-H	300	chrome matt
● 2-39302	2-39302-H	300	chrome
● 2-39303	2-39303-H	300	nickel matt
● 2-39302-22	2-39302-H-22	300	white matt/chr.
● 2-39302-02	2-39302-H-02	300	black matt/chr.
● 2-39302-23	2-39302-H-23	300	anthracite matt/chr.
● 2-39401	2-39401-H	400	chrome matt
● 2-39402	2-39402-H	400	chrome
● 2-39403	2-39403-H	400	nickel matt
● 2-39402-22	2-39402-H-22	400	white matt/chr.
● 2-39402-02	2-39402-H-02	400	black matt/chr.
● 2-39402-23	2-39402-H-23	400	anthracite matt/chr.
● 2-39601	2-39601-H	600	chrome matt
● 2-39602	2-39602-H	600	chrome
● 2-39603	2-39603-H	600	nickel matt
● 2-39602-22	2-39602-H-22	600	white matt/chr.
● 2-39602-02	2-39602-H-02	600	black matt/chr.
● 2-39602-23	2-39602-H-23	600	anthracite matt/chr.
● 2-39801	2-39801-H	800	chrome matt
● 2-39802	2-39802-H	800	chrome
● 2-39803	2-39803-H	800	nickel matt
● 2-39802-22	2-39802-H-22	800	white matt/chr.
● 2-39802-02	2-39802-H-02	800	black matt/chr.
● 2-39802-23	2-39802-H-23	800	anthracite matt/chr.
● 2-391001	2-391001-H	1.000	chrome matt
● 2-391002	2-391002-H	1.000	chrome
● 2-391003	2-391003-H	1.000	nickel matt
● 2-391002-22	2-391002-H-22	1.000	white matt/chr.
● 2-391002-02	2-391002-H-02	1.000	black matt/chr.
● 2-391002-23	2-391002-H-23	1.000	anthracite matt/chr.
● 2-391201	2-391201-H	1.250	chrome matt
● 2-391202	2-391202-H	1.250	chrome
● 2-391203	2-391203-H	1.250	nickel matt
● 2-391202-22	2-391202-H-22	1.250	white matt/chr.
● 2-391202-02	2-391202-H-02	1.250	black matt/chr.
● 2-391202-23	2-391202-H-23	1.250	anthracite matt/chr.



chrome

Chrom Teile/
chrome parts
 Gepulverte Teile/
powder-coating

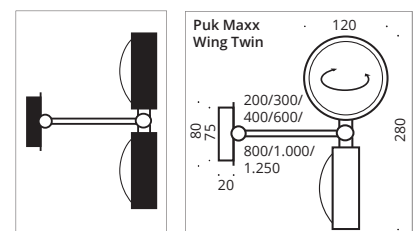

▶ Ohne Zubehör. Bestell-Artikelnummern für Linse, Glas, Farbfilter und die Konfigurationsempfehlung (2) auf der Einklappseite!



▶ Without accessories: Order item-no. for lens, glass, color filter and the recommended Configuration (2) are on the fold-in page!

G9 max. 33W ECO, optional LED Retrofit
 G9 max. 33W ECO, LED Retrofit optional

Leuchtmittelempfehlung: LED max. 3W/300lm/2.700K/dimmbar Art. Nr. 8-205
 bulb recommendation: LED max. 3W/300lm/2.700K/dimmable Item No. 8-205



BC (s.S 6-7/s.p. 6-7)

INDOOR





Puk Maxx Next ø 120

Deckenleuchte, Hochvolt LED Power oder Hochvolt Halogen, dimmbar. Diese Aufbauleuchte wurde für den Wand- und Deckeneinsatz konstruiert. Mit zwei kardanis aufeinander abgestimmten Gelenken, lassen sich die Leuchtenköpfe um über 360 Grad auf zwei Achsen in jede Richtung einstellen.

Ceiling lamp, high voltage LED power or high voltage halogen, dimmable. The shaped lamp is dimmable and has been designed for ceilings and walls. With its two coordinated gimbal-joints the head can be turned in two axes for more than over 360° in each direction.

INDOOR

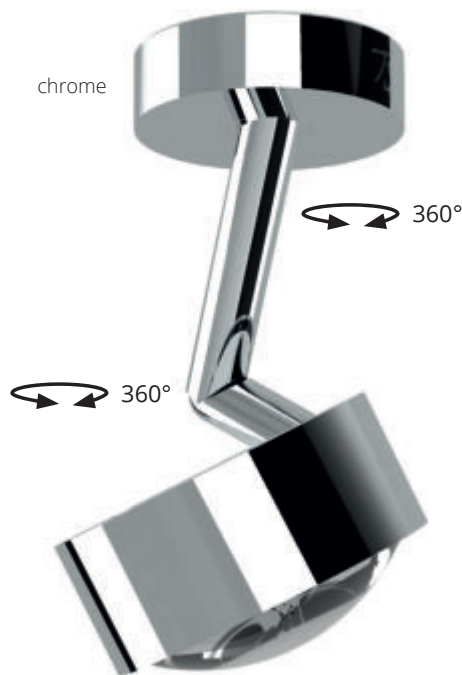
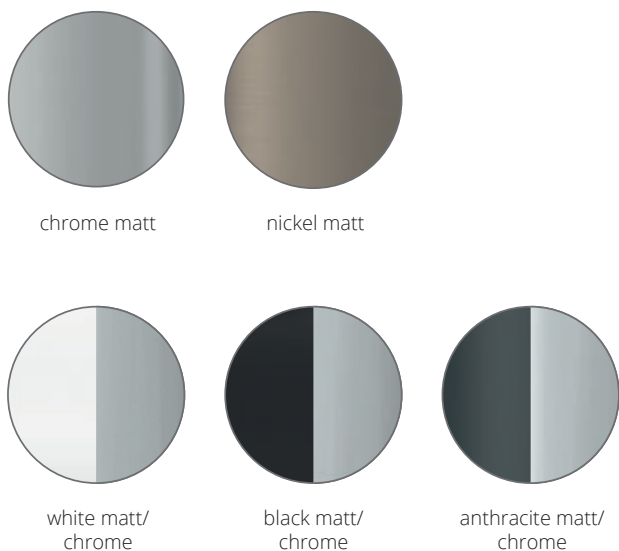

Puk Maxx Next LED ~2.700k	Puk Maxx Next G9 Fassung	Kopf ø Head ø in mm	Gehäuse body
downlight 1 x 12W, ~900lm	downlight		
2-30721	2-30721-H	120	chrome matt
2-30722	2-30722-H	120	chrome
2-30723	2-30723-H	120	nickel matt
2-30722-22	2-30722-H-22	120	white matt/chr.
2-30722-02	2-30722-H-02	120	black matt/chr.
2-30722-23	2-30722-H-23	120	anthracite matt/chr.
up- & downlight 2 x 12W, ~1.800lm	up- & downlight		
2-30731	2-30731-H	120	chrome matt
2-30732	2-30732-H	120	chrome
2-30733	2-30733-H	120	nickel matt
2-30732-22	2-30732-H-22	120	white matt/chr.
2-30732-02	2-30732-H-02	120	black matt/chr.
2-30732-23	2-30732-H-23	120	anthracite matt/chr.

▶ Ohne Zubehör. Bestell-Artikelnummern für Linse, Glas, Farbfilter und die Konfigurationsempfehlung (2) auf der Einklappseite!



▶ Without accessories: Order item-no. for lens, glass, color filter and the recommended Configuration (2) are on the fold-in page!

G9 max. 33W ECO, optional LED Retrofit
G9 max. 33W ECO, LED Retrofit optional

Leuchtmittelempfehlung: LED max. 3W/300lm/2.700K/dimmbar Art. Nr. 8-205
bulb recommendation: LED max. 3W/300Lm/2.700K/dimmable Item No. 8-205

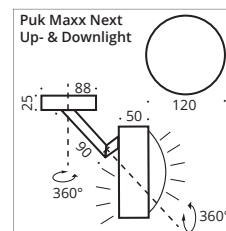
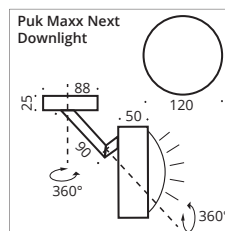
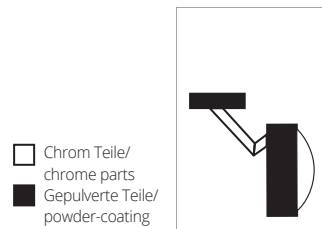





Puk Meg Maxx Next ø 160

Diese Aufbauleuchte wurde für den Wand- und Deckeneinsatz konstruiert, dimmbar. Mit zwei kardanis aufeinander abgestimmten Gelenken, lassen sich die LED oder Halogen Leuchtenköpfe um über 360° drehen.

The shaped lamp is dimmable and has been designed for ceilings and walls. With its two coordinated gimballed joints the LED or halogen lighted head can be turned for more than over 360°.

INDOOR

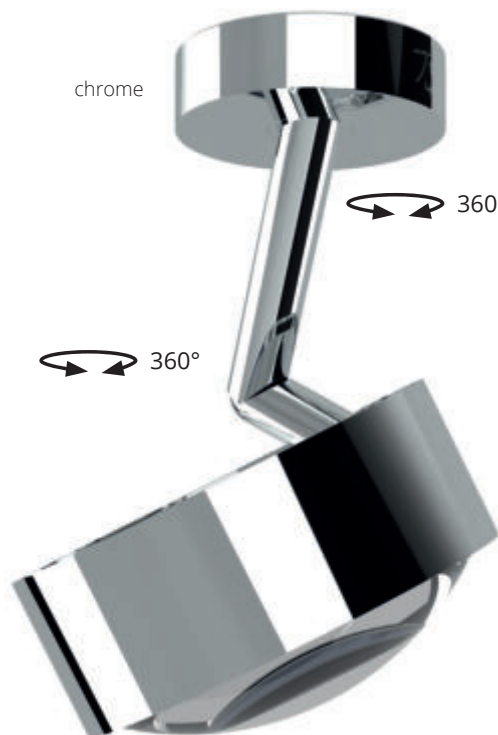
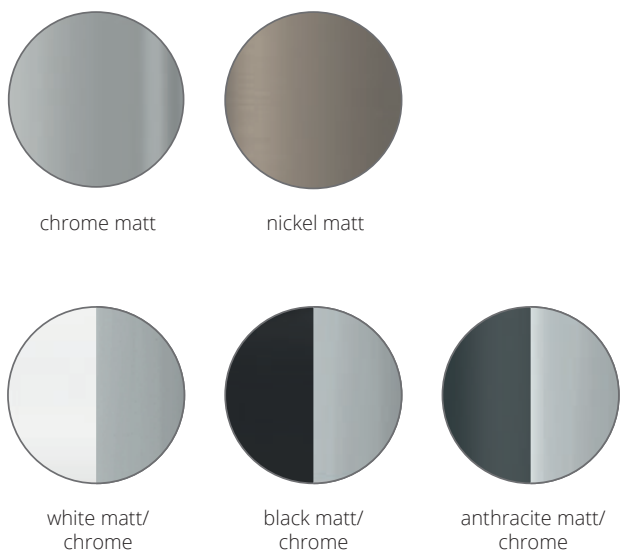

Puk Meg Maxx Next LED G ~2.700k	Puk Meg Maxx Next G9 Fassung	Kopf ø Head ø in mm	Gehäuse body
downlight 1 x 16W, ~1.200lm	downlight		
2-50721	2-50721-H	160	chrome matt
2-50722	2-50722-H	160	chrome
2-50723	2-50723-H	160	nickel matt
2-50722-22	2-50722-H-22	160	white matt/chr.
2-50722-02	2-50722-H-02	160	black matt/chr.
2-50722-23	2-50722-H-23	160	anthracite matt/chr.
up- & downlight 2 x 16W, ~2.400lm	up- & downlight		
2-50731	2-50731-H	160	chrome matt
2-50732	2-50732-H	160	chrome
2-50733	2-50733-H	160	nickel matt
2-50732-22	2-50732-H-22	160	white matt/chr.
2-50732-02	2-50732-H-02	160	black matt/chr.
2-50732-23	2-50732-H-23	160	anthracite matt/chr.

► Ohne Zubehör. Bestell-Artikelnummern für Linse, Glas, Farbfilter und die Konfigurationsempfehlung (2) auf der Einklappseite!

► Without accessories: Order item-no. for lens, glass, color filter and the recommended Configuration (2) are on the fold-in page!

G9 max. 33W ECO, optional LED Retrofit
 G9 max. 33W ECO, LED Retrofit optional

Leuchtmittelempfehlung: LED max. 3W/300lm/2.700K/dimmbar Art. Nr. 8-205
 bulb recommendation: LED max. 3W/300Lm/2.700K/dimmable Item No. 8-205

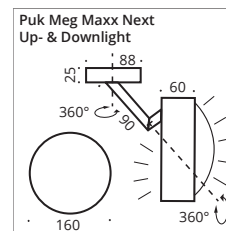
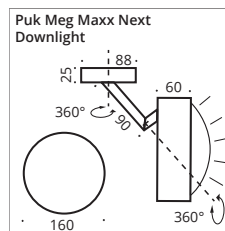
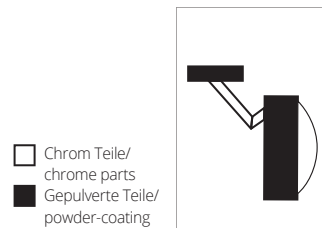



Puk Mini Ceiling Sister Twin



Puk Mini Ceiling Sister Twin ø 80

Deckenleuchte, Hochvolt Halogen oder LED Power, dimmbar, Köpfe drehbar mit Verstellstift, Arme schwenkbar.
Ceiling lamp, high voltage halogen or LED power, dimmable, heads rotatable with adjusting pin, arms titable.

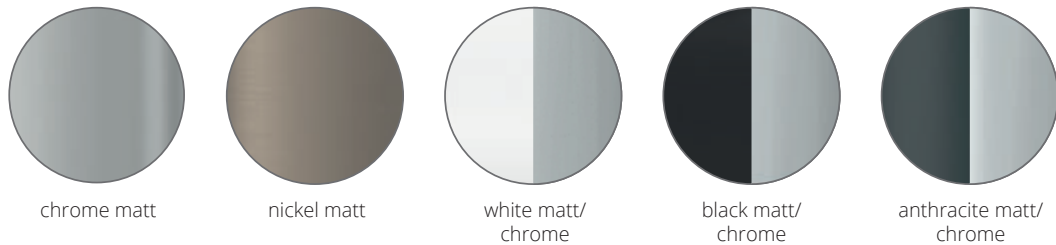

INDOOR

Puk Ceiling Sister LED G 8 x 8W ~4.800lm ~2.700k	Puk Ceiling Sister G9 Fassung	Arm Länge arm length in mm	Gehäuse body
5-081201-2-LED	5-081201-2	200	chrome matt
5-081202-2-LED	5-081202-2	200	chrome
5-081203-2-LED	5-081203-2	200	nickel matt
5-081202-2-LED-22	5-081202-2-22	200	white matt/chr.
5-081202-2-LED-02	5-081202-2-02	200	black matt/chr.
5-081202-2-LED-23	5-081202-2-23	200	anthracite matt/chr.
5-081401-2-LED	5-081401-2	400	chrome matt
5-081402-2-LED	5-081402-2	400	chrome
5-081403-2-LED	5-081403-2	400	nickel matt
5-081402-2-LED-22	5-081402-2-22	400	white matt/chr.
5-081402-2-LED-02	5-081402-2-02	400	black matt/chr.
5-081402-2-LED-23	5-081402-2-23	400	anthracite matt/chr.
5-081601-2-LED	5-081601-2	600	chrome matt
5-081602-2-LED	5-081602-2	600	chrome
5-081603-2-LED	5-081603-2	600	nickel matt
5-081602-2-LED-22	5-081602-2-22	600	white matt/chr.
5-081602-2-LED-02	5-081602-2-02	600	black matt/chr.
5-081602-2-LED-23	5-081602-2-23	600	anthracite matt/chr.
5-081801-2-LED	5-081801-2	800	chrome matt
5-081802-2-LED	5-081802-2	800	chrome
5-081803-2-LED	5-081803-2	800	nickel matt
5-081802-2-LED-22	5-081802-2-22	800	white matt/chr.
5-081802-2-LED-02	5-081802-2-02	800	black matt/chr.
5-081802-2-LED-23	5-081802-2-23	800	anthracite matt/chr.
5-0811001-2-LED	5-0811001-2	1.000	chrome matt
5-0811002-2-LED	5-0811002-2	1.000	chrome
5-0811003-2-LED	5-0811003-2	1.000	nickel matt
5-0811002-2-LED-22	5-0811002-2-22	1.000	white matt/chr.
5-0811002-2-LED-02	5-0811002-2-02	1.000	black matt/chr.
5-0811002-2-LED-23	5-0811002-2-23	1.000	anthracite matt/chr.
5-0811201-2-LED	5-0811201-2	1.250	chrome matt
5-0811202-2-LED	5-0811202-2	1.250	chrome
5-0811203-2-LED	5-0811203-2	1.250	nickel matt
5-0811202-2-LED-22	5-0811202-2-22	1.250	white matt/chr.
5-0811202-2-LED-02	5-0811202-2-02	1.250	black matt/chr.
5-0811202-2-LED-23	5-0811202-2-23	1.250	anthracite matt/chr.

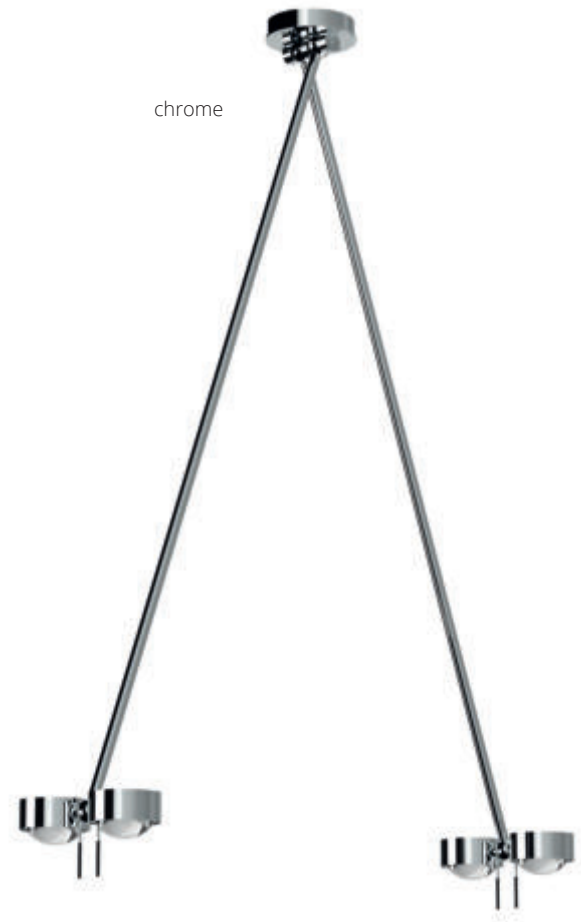

► Ohne Zubehör. Bestell-Artikelnummern für Linse, Glas, Farbfilter und die Konfigurationsempfehlung (2) auf der Einklappseite!



► Without accessories: Order item-no. for lens, glass, color filter and the recommended Configuration (2) are on the fold-in page!

G9 max. 33W ECO, optional LED Retrofit
 G9 max. 33W ECO, LED Retrofit optional

Leuchtmittelempfehlung: LED max. 3W/300lm/2.700K/dimmbar **G** Art. Nr. 8-205
 bulb recommendation: LED max. 3W/300Lm/2.700K/dimmable **G** Item No. 8-205



Chrom Teile/
chrome parts
 Gepulverte Teile/
powder-coating

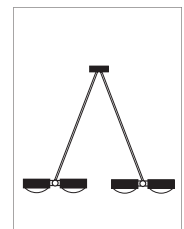
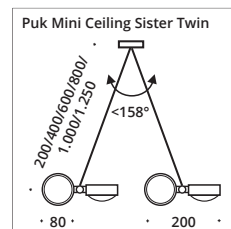





Puk Maxx Ceiling Sister Single ø 120

Deckenleuchte, Hochvolt Halogen oder LED Power, dimmbar, Köpfe drehbar, Arme schwenkbar.
Ceiling lamp, high voltage halogen or LED power, dimmable, heads rotatable, arms titable.

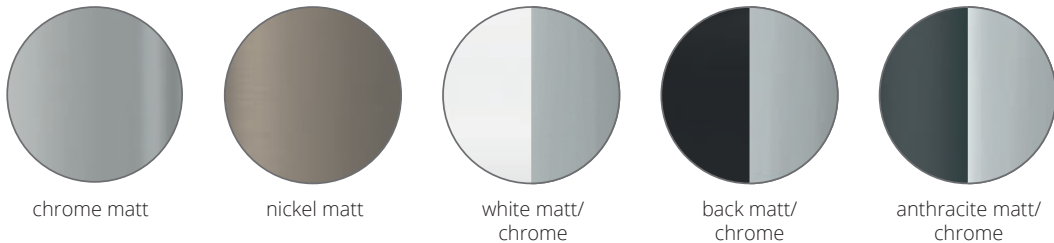

INDOOR

Puk Maxx Ceiling Sister LED 4 x 12W ~3.600lm ~2.700k	Puk Maxx Ceiling Sister G9 Fassung	Arm Länge arm length in mm	Gehäuse body
5-381201-2	5-381201-2-H	200	chrome matt
5-381202-2	5-381202-2-H	200	chrome
5-381203-2	5-381203-2-H	200	nickel matt
5-381202-2-22	5-381202-2-H-22	200	white matt/chr.
5-381202-2-02	5-381202-2-H-02	200	black matt/chr.
5-381202-2-23	5-381202-2-H-23	200	anthracite matt/chr.
5-381401-2	5-381401-2-H	400	chrome matt
5-381402-2	5-381402-2-H	400	chrome
5-381403-2	5-381403-2-H	400	nickel matt
5-381402-2-22	5-381402-2-H-22	400	white matt/chr.
5-381402-2-02	5-381402-2-H-02	400	black matt/chr.
5-381402-2-23	5-381402-2-H-23	400	anthracite matt/chr.
5-381601-2	5-381601-2-H	600	chrome matt
5-381602-2	5-381602-2-H	600	chrome
5-381603-2	5-381603-2-H	600	nickel matt
5-381602-2-22	5-381602-2-H-22	600	white matt/chr.
5-381602-2-02	5-381602-2-H-02	600	black matt/chr.
5-381602-2-23	5-381602-2-H-23	600	anthracite matt/chr.
5-381801-2	5-381801-2-H	800	chrome matt
5-381802-2	5-381802-2-H	800	chrome
5-381803-2	5-381803-2-H	800	nickel matt
5-381802-2-22	5-381802-2-H-22	800	white matt/chr.
5-381802-2-02	5-381802-2-H-02	800	black matt/chr.
5-381802-2-23	5-381802-2-H-23	800	anthracite matt/chr.
5-3811001-2	5-3811001-2-H	1.000	chrome matt
5-3811002-2	5-3811002-2-H	1.000	chrome
5-3811003-2	5-3811003-2-H	1.000	nickel matt
5-3811002-2-22	5-3811002-2-H-22	1.000	white matt/chr.
5-3811002-2-02	5-3811002-2-H-02	1.000	black matt/chr.
5-3811002-2-23	5-3811002-2-H-23	1.000	anthracite matt/chr.
5-3811201-2	5-3811201-2-H	1.250	chrome matt
5-3811202-2	5-3811202-2-H	1.250	chrome
5-3811203-2	5-3811203-2-H	1.250	nickel matt
5-3811202-2-22	5-3811202-2-H-22	1.250	white matt/chr.
5-3811202-2-02	5-3811202-2-H-02	1.250	black matt/chr.
5-3811202-2-23	5-3811202-2-H-23	1.250	anthracite matt/chr.



► Ohne Zubehör. Bestell-Artikelnummern für Linse, Glas, Farbfilter und die Konfigurationsempfehlung (2) auf der Einklapppseite!

► Without accessories: Order item-no. for lens, glass, color filter and the recommended Configuration (2) are on the fold-in page!

G9 max. 33W ECO, optional LED Retrofit
 G9 max. 33W ECO, LED Retrofit optional

Leuchtmittelempfehlung: LED max. 3W/300lm/2.700K/dimmbar Art. Nr. 8-205
 bulb recommendation: LED max. 3W/300Lm/2.700K/dimmable Item No. 8-205

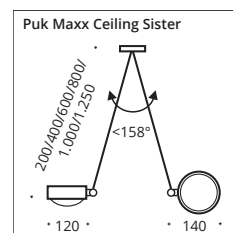

Chrom Teile/
chrome parts
 Gepulverte Teile/
powder-coating

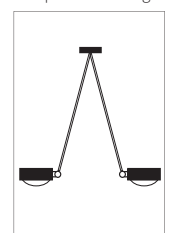





Puk Mini Choice Move ø 80

Deckenleuchte, Hochvolt LED Power oder Hochvolt Halogen, dimmbar. Der Lichtbalken besteht mit dreh- (360°) und schwenkbaren (±106°) Puk Mini Move Leuchten. Direktmontage an der Decke.

Ceiling lamp, high voltage LED power or high voltage halogen, dimmable. The light bar impresses with rotatable (360°) and swivelling (±106°) Puk Mini Move luminaires. For direct ceiling mounting.

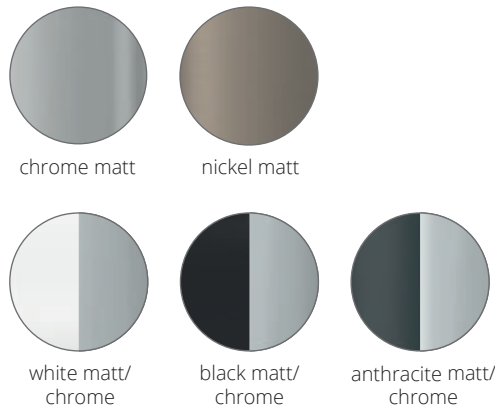

INDOOR

G9 Fassung

450 mm L 2 Köpfe/heads	850 mm L 3 Köpfe/heads	1.050 mm L 4 Köpfe/heads	1.250 mm L 4 Köpfe/heads	Gehäuse body
8-769401-H	8-769801-H	8-7691001-H	8-7691201-H	chrome matt
8-769402-H	8-769802-H	8-7691002-H	8-7691202-H	chrome
8-769403-H	8-769803-H	8-7691003-H	8-7691203-H	nickel matt
8-769402-H-22	8-769802-H-22	8-7691002-H-22	8-7691202-H-22	white matt/chrome
8-769402-H-02	8-769802-H-02	8-7691002-H-02	8-7691202-H-02	black matt/chrome
8-769402-H-23	8-769802-H-23	8-7691002-H-23	8-7691202-H-23	anthracite matt/chrome

Farbig gepulverter Lichtbalken auf Anfrage. Color powdered metal rail on request.

- ▶ Ohne Zubehör. Bestell-Artikelnummern für Linse, Glas, Farbfilter und die Konfigurationsempfehlung (2) auf der Einklappseite!
- ▶ Without accessories: Order item-no. for lens, glass, color filter and the recommended Configuration (2) are on the fold-in page!

- 💡 G9 max. 3W ECO, optional LED Retrofit
- 💡 G9 max. 3W ECO, LED Retrofit optional

- 💡 Leuchtmittelempfehlung: LED max. 3W/300lm/2.700K/dimmbar **G** Art. Nr. 8-205
- 💡 bulb recommendation: LED max. 3W/300Lm/2.700K/dimmable **G** Item No. 8-205

LED

450 mm L 2 Köpfe/heads G 2 x 8W, ~2.700k, ~1.200lm	850 mm L 3 Köpfe/heads G 3 x 8W, ~2.700k, ~1.800lm	1.050 mm L 4 Köpfe/heads G 4 x 8W, ~2.700k, ~2.400lm	1.250 mm L 4 Köpfe/heads G 4 x 8W, ~2.700k, ~2.400lm	Gehäuse body
8-769401	8-769801	8-7691001	8-7691201	chrome matt
8-769402	8-769802	8-7691002	8-7691202	chrome
8-769403	8-769803	8-7691003	8-7691203	nickel matt
8-769402-22	8-769802-22	8-7691002-22	8-7691202-22	white matt/chrome
8-769402-02	8-769802-02	8-7691002-02	8-7691202-02	black matt/chrome
8-769402-23	8-769802-23	8-7691002-23	8-7691202-23	anthracite matt/chrome

Farbig gepulverter Lichtbalken auf Anfrage. Color powdered metal rail on request.

- ▶ Ohne Zubehör. Bestell-Artikelnummern für Linse, Glas, Farbfilter und die Konfigurationsempfehlung (2) auf der Einklappseite!
- ▶ Without accessories: Order item-no. for lens, glass, color filter and the recommended Configuration (2) are on the fold-in page!

Sonderanfertigung:

Art-Nr. 8-600 Kürzung auf Maß
Item No. 8-600 Customized lengths

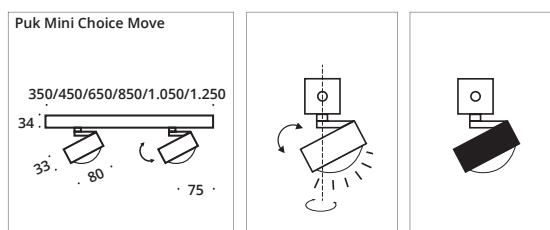

☐ Chrom Teile/
chrome parts
■ Gepulverte Teile/
powder-coating





Puk Maxx Choice Move ø 120

Deckenleuchte, Hochvolt LED Power oder Hochvolt Halogen, dimmbar. Der Lichtbalken besteht mit dreh- (360°) und schwenkbaren (±106°) Puk Maxx Move Leuchten. Zur Direktmontage an der Decke.

Ceiling lamp, high voltage LED power or high voltage halogen, dimmable. The light bar impresses with rotatable (360°) and swivelling (± 106°) Puk Maxx Move luminaires. For direct ceiling mounting.

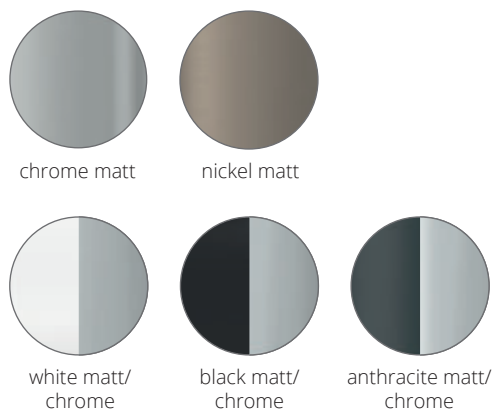

INDOOR

G9 Fassung

450 mm L 2 Köpfe/heads	850 mm L 3 Köpfe/heads	1.050 mm L 4 Köpfe/heads	1.250 mm L 4 Köpfe/heads	Gehäuse body
8-789401-H	8-789801-H	8-7891001-H	8-7891201-H	chrome matt
8-789402-H	8-789802-H	8-7891002-H	8-7891202-H	chrome
8-789403-H	8-789803-H	8-7891003-H	8-7891203-H	nickel matt
8-789402-H-22	8-789802-H-22	8-7891002-H-22	8-7891202-H-22	white matt/chrome
8-789402-H-02	8-789802-H-02	8-7891002-H-02	8-7891202-H-02	black matt/chrome
8-789402-H-23	8-789802-H-23	8-7891002-H-23	8-7891202-H-23	anthracite matt/chrome

Farbig gepulverter Lichtbalken auf Anfrage. Color powdered metal rail on request.

- ▶ Ohne Zubehör. Bestell-Artikelnummern für Linse, Glas, Farbfilter und die Konfigurationsempfehlung (2) auf der Einklappseite!
- ▶ Without accessories: Order item-no. for lens, glass, color filter and the recommended Configuration (2) are on the fold-in page!

- 💡 G9 max. 5W ECO, optional LED Retrofit
- 💡 G9 max. 5W ECO, LED Retrofit optional

- 💡 Leuchtmittlempfehlung: LED max. 3W/300lm/2.700K/dimmbar **G** Art. Nr. 8-205
- 💡 bulb recommendation: LED max. 3W/300lm/2.700K/dimmable **G** Item No. 8-205

LED

450 mm L 2 Köpfe/heads G 2 x 12W, ~2.700k, ~1.800lm	850 mm L 3 Köpfe/heads G 3 x 12W, ~2.700k, ~2.700lm	1.050 mm L 4 Köpfe/heads G 4 x 12W, ~2.700k, ~3.600lm	1.250 mm L 4 Köpfe/heads G 4 x 12W, ~2.700k, ~3.600lm	Gehäuse body
8-789401	8-789801	8-7891001	8-7891201	chrome matt
8-789402	8-789802	8-7891002	8-7891202	chrome
8-789403	8-789803	8-7891003	8-7891203	nickel matt
8-789402-22	8-789802-22	8-7891002-22	8-7891202-22	white matt/chrome
8-789402-02	8-789802-02	8-7891002-02	8-7891202-02	black matt/chrome
8-789402-23	8-789802-23	8-7891002-23	8-7891202-23	anthracite matt/chrome

Farbig gepulverter Lichtbalken auf Anfrage. Color powdered metal rail on request.

- ▶ Ohne Zubehör. Bestell-Artikelnummern für Linse, Glas, Farbfilter und die Konfigurationsempfehlung (2) auf der Einklappseite!
- ▶ Without accessories: Order item-no. for lens, glass, color filter and the recommended Configuration (2) are on the fold-in page!

Sonderanfertigung:

Art-Nr. 8-600 Kürzung auf Maß

Item No. 8-600 Customized lengths

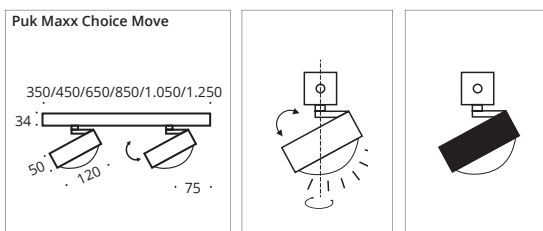





Puk Mini Choice Turn Ø 80

Deckenleuchte, Hochvolt LED Power oder Hochvolt Halogen, dimmbar. Der Lichtbalken ist bestückt mit dreh- und schwenkbaren Puk Mini Turn Leuchten. Zur Direktmontage an der Decke.

Ceiling lamp, high voltage LED power or high voltage halogen, dimmable. The light bar is equipped with rotatable and swivelling Puk Mini Choice Turn luminaires. For direct ceiling mounting.

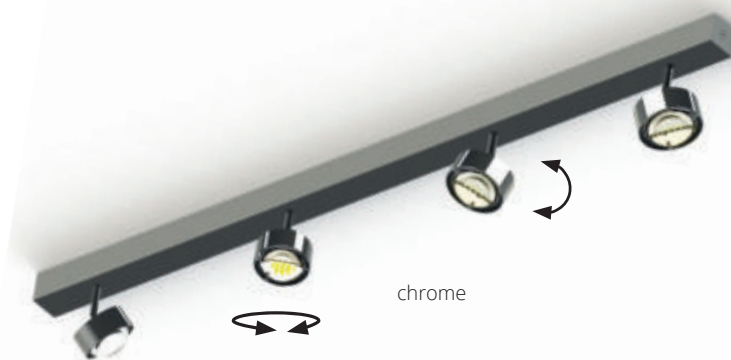
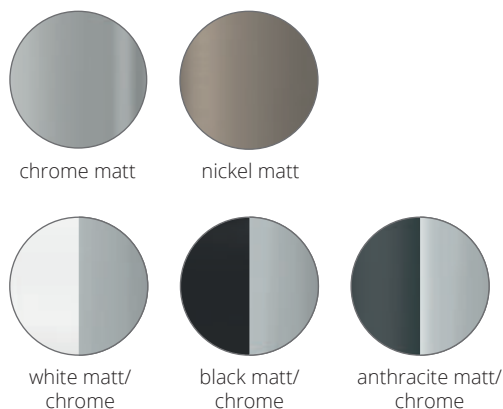

INDOOR

G9 Fassung

450 mm L 2 Köpfe/heads	850 mm L 3 Köpfe/heads	1.050 mm L 4 Köpfe/heads	1.250 mm L 4 Köpfe/heads	Gehäuse body
8-62284021-H	8-62288031-H	8-622810041-H	8-622812041-H	chrome matt
8-62284022-H	8-62288032-H	8-622810042-H	8-622812042-H	chrome
8-62284023-H	8-62288033-H	8-622810043-H	8-622812043-H	nickel matt
8-62284022-H-22	8-62288032-H-22	8-622810042-H-22	8-622812042-H-22	white matt/chrome
8-62284022-H-02	8-62288032-H-02	8-622810042-H-02	8-622812042-H-02	black matt/chrome
8-62284022-H-23	8-62288032-H-23	8-622810042-H-23	8-622812042-H-23	anthracite matt/chr.

Farbig gepulverter Lichtbalken auf Anfrage. Color powdered metal rail on request.

- ▶ Ohne Zubehör. Bestell-Artikelnummern für Linse, Glas, Farbfilter und die Konfigurationsempfehlung (2) auf der Einklappseite!
- ▶ Without accessories: Order item-no. for lens, glass, color filter and the recommended Configuration (2) are on the fold-in page!

G9 max. 33W ECO, optional LED Retrofit
 G9 max. 33W ECO, LED Retrofit optional

Leuchtmittelempfehlung: LED max. 3W/300lm/2.700K/dimmbar **G** Art. Nr. 8-205
 bulb recommendation: LED max. 3W/300Lm/2.700K/dimmable **G** Item No. 8-205

LED

450 mm L 2 Köpfe/heads G 4 x 8W, ~2.700k, ~2.400lm	850 mm L 3 Köpfe/heads G 6 x 8W, ~2.700k, ~3.600lm	1.050 mm L 4 Köpfe/heads G 8 x 8W, ~2.700k, ~4.800lm	1.250 mm L 4 Köpfe/heads G 8 x 8W, ~2.700k, ~4.800lm	Gehäuse body
8-62284021	8-62288031	8-622810041	8-622812041	chrome matt
8-62284022	8-62288032	8-622810042	8-622812042	chrome
8-62284023	8-62288033	8-622810043	8-622812043	nickel matt
8-62284022-22	8-62288032-22	8-622810042-22	8-622812042-22	white matt/chrome
8-62284022-02	8-62288032-02	8-622810042-02	8-622812042-02	black matt/chrome
8-62284022-23	8-62288032-23	8-622810042-23	8-622812042-23	anthracite matt/chr.

Farbig gepulverter Lichtbalken auf Anfrage. Color powdered metal rail on request.

- ▶ Ohne Zubehör. Bestell-Artikelnummern für Linse, Glas, Farbfilter und die Konfigurationsempfehlung (2) auf der Einklappseite!
- ▶ Without accessories: Order item-no. for lens, glass, color filter and the recommended Configuration (2) are on the fold-in page!

Sonderanfertigung:
 Art-Nr. 8-600 Kürzung auf Maß
 Item No. 8-600 Customized lengths

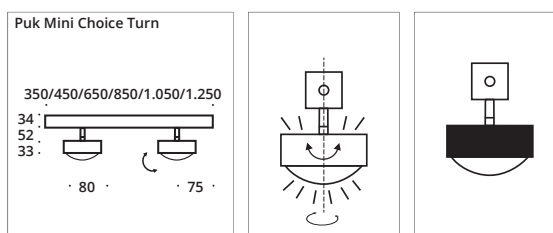

□ Chrom Teile/
chrome parts
■ Gepulverte Teile/
powder-coating





Puk Maxx Choice Turn ø 120

Deckenleuchte, Hochvolt LED Power oder Hochvolt Halogen, dimmbar. Der Lichtbalken ist bestückt mit dreh- und schwenkbaren Puk Maxx Turn Leuchten. Zur Direktmontage an der Decke.

Ceiling lamp, high voltage LED power or high voltage halogen, dimmable. The light bar is equipped with rotatable and swivelling Puk Maxx Choice Turn luminaires. For direct ceiling mounting.

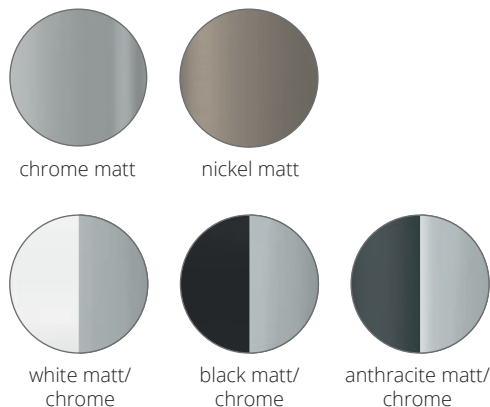

INDOOR

G9 Fassung

450 mm L 2 Köpfe/heads	850 mm L 3 Köpfe/heads	1.050 mm L 4 Köpfe/heads	1.250 mm L 4 Köpfe/heads	Gehäuse body
8-66284021-H	8-66288031-H	8-662810041-H	8-662812041-H	chrome matt
8-66284022-H	8-66288032-H	8-662810042-H	8-662812042-H	chrome
8-66284023-H	8-66288033-H	8-662810043-H	8-662812043-H	nickel matt
8-66284022-H-22	8-66288032-H-22	8-662810042-H-22	8-662812042-H-22	white matt/chrome
8-66284022-H-02	8-66288032-H-02	8-662810042-H-02	8-662812042-H-02	black matt/chrome
8-66284027-H-23	8-66288037-H-23	8-662810047-H-23	8-662812047-H-23	anthracite matt/chr.

Farbig gepulverter Lichtbalken auf Anfrage. Color powdered metal rail on request.

▶ Ohne Zubehör. Bestell-Artikelnummern für Linse, Glas, Farbfilter und die Konfigurationsempfehlung (2) auf der Einklappseite!

▶ Without accessories: Order item-no. for lens, glass, color filter and the recommended Configuration (2) are on the fold-in page!



💡 G9 max. 33W ECO, optional LED Retrofit

💡 G9 max. 33W ECO, LED Retrofit optional

💡 Leuchtmittelempfehlung: LED max. 3W/300lm/2.700K/dimmbar **G** Art. Nr. 8-205

💡 bulb recommendation: LED max. 3W/300Lm/2.700K/dimmable **G** Item No. 8-205

LED

450 mm L 2 Köpfe/heads G 4 x 12W, ~2.700k, ~3.600lm	850 mm L 3 Köpfe/heads G 6 x 12W, ~2.700k, ~5.400lm	1.050 mm L 4 Köpfe/heads G 8 x 12W, ~2.700k, ~7.200lm	1.250 mm L 4 Köpfe/heads G 8 x 12W, ~2.700k, ~7.200lm	Gehäuse body
8-66284021	8-66288031	8-662810041	8-662812041	chrome matt
8-66284022	8-66288032	8-662810042	8-662812042	chrome
8-66284023	8-66288033	8-662810043	8-662812043	nickel matt
8-66284022-22	8-66288032-22	8-662810042-22	8-662812042-22	white matt/chrome
8-66284022-02	8-66288032-02	8-662810042-02	8-662812042-02	black matt/chrome
8-66284022-23	8-66288032-23	8-662810042-23	8-662812042-23	anthracite matt/chr.

Farbig gepulverter Lichtbalken = Preis auf Anfrage. Color powdered metal rail = price on request.

▶ Ohne Zubehör. Bestell-Artikelnummern für Linse, Glas, Farbfilter und die Konfigurationsempfehlung (2) auf der Einklappseite!

▶ Without accessories: Order item-no. for lens, glass, color filter and the recommended Configuration (2) are on the fold-in page!



Sonderanfertigung:

Art-Nr. 8-600 Kürzung auf Maß

Item No. 8-600 Customized lengths

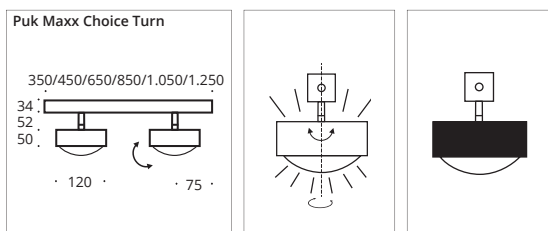





Puk Mini Choice Eye Ø 80

Deckenleuchte, Hochvolt LED Power oder Hochvolt Halogen, dimmbar. Der Lichtbalken ist bestückt mit starren Puk Eye Leuchten (up- & downlight). Zur Direktmontage an der Decke.

Ceiling lamp, high voltage LED power or high voltage halogen, dimmable. The light bar is equipped with rigid Puk Mini Choice Eye luminaires (up- & downlight). For direct ceiling mounting.

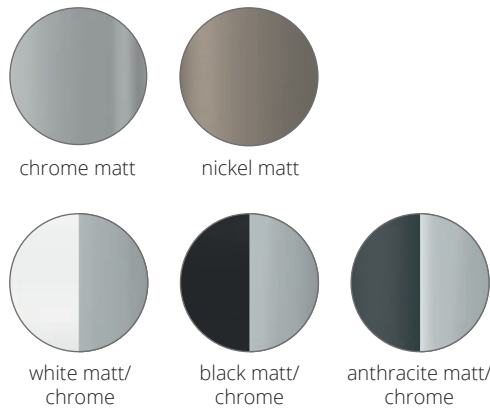

Fest installierte obere Linse.
Permanently installed lens.

chrome

INDOOR

G9 Fassung

450 mm L 2 Köpfe/heads	850 mm L 3 Köpfe/heads	1.050 mm L 4 Köpfe/heads	1.250 mm L 4 Köpfe/heads	Gehäuse body
8-6174021-H	8-6178031-H	8-61710041-H	8-61712041-H	chrome matt
8-6174022-H	8-6178032-H	8-61710042-H	8-61712042-H	chrome
8-6174023-H	8-6178033-H	8-61710043-H	8-61712043-H	nickel matt
8-6174022-H-22	8-6178032-H-22	8-61710042-H-22	8-61712042-H-22	white matt/chrome
8-6174022-H-02	8-6178032-H-02	8-61710042-H-02	8-61712042-H-02	black matt/chrome
8-6174022-H-23	8-6178032-H-23	8-61710042-H-23	8-61712042-H-23	anthracite matt/chr.

Farbig gepulverter Lichtbalken auf Anfrage. Color powdered metal rail on request.

- ▶ Ohne Zubehör. Bestell-Artikelnummern für Linse, Glas, Farbfilter und die Konfigurationsempfehlung (2) auf der Einklappseite!
- ▶ Without accessories: Order item-no. for lens, glass, color filter and the recommended Configuration (2) are on the fold-in page!

G9 max. 33W ECO, optional LED Retrofit
G9 max. 33W ECO, LED Retrofit optional

Leuchtmittlempfehlung: LED max. 3W/300lm/2.700K/dimmbar **G** Art. Nr. 8-205
bulb recommendation: LED max. 3W/300lm/2.700K/dimmable **G** Item No. 8-205

LED

450 mm L 2 Köpfe/heads G 4 x 8W, ~2.700k, ~2.400lm	850 mm L 3 Köpfe/heads G 6 x 8W, ~2.700k, ~3.600lm	1.050 mm L 4 Köpfe/heads G 8 x 8W, ~2.700k, ~4.800lm	1.250 mm L 4 Köpfe/heads G 8 x 8W, ~2.700k, ~4.800lm	Gehäuse body
8-6174021	8-6178031	8-61710041	8-61712041	chrome matt
8-6174022	8-6178032	8-61710042	8-61712042	chrome
8-6174023	8-6178033	8-61710043	8-61712043	nickel matt
8-6174022-22	8-6178032-22	8-61710042-22	8-61712042-22	white matt/chrome
8-6174022-02	8-6178032-02	8-61710042-02	8-61712042-02	black matt/chrome
8-6174022-23	8-6178032-23	8-61710042-23	8-61712042-23	anthracite matt/chr.

Farbig gepulverter Lichtbalken auf Anfrage. Color powdered metal rail on request.

- ▶ Ohne Zubehör. Bestell-Artikelnummern für Linse, Glas, Farbfilter und die Konfigurationsempfehlung (2) auf der Einklappseite!
- ▶ Without accessories: Order item-no. for lens, glass, color filter and the recommended Configuration (2) are on the fold-in page!

Sonderanfertigung:
Art-Nr. 8-600 Kürzung auf Maß
Item No. 8-600 Customized lengths

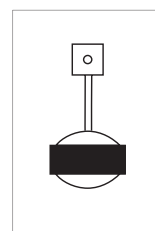
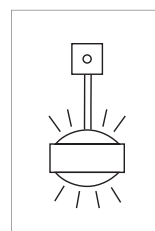
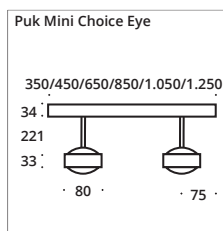

□ Chrom Teile/
chrome parts
■ Gepulverte Teile/
powder-coating





Puk Maxx Choice Eye ø 120

Deckenleuchte, Hochvolt LED Power oder Hochvolt Halogen, dimmbar. Der Lichtbalken ist bestückt mit starren Puk Maxx Choice Eye Leuchten (up- & downlight). Zur Direktmontage an der Decke.

Ceiling lamp, high voltage LED power or high voltage halogen, dimmable. The light bar is equipped with rigid Puk Maxx Choice Eye luminaires (up-& downlight). For direct ceiling mounting.

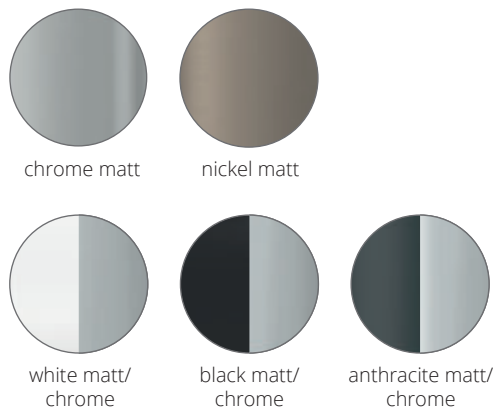

INDOOR

G9 Fassung

450 mm L 2 Köpfe/heads	850 mm L 3 Köpfe/heads	1.050 mm L 4 Köpfe/heads	1.250 mm L 4 Köpfe/heads	Gehäuse body
8-6974021-H	8-6978031-H	8-69710041-H	8-69712041-H	chrome matt
8-6974022-H	8-6978032-H	8-69710042-H	8-69712042-H	chrome
8-6974023-H	8-6978033-H	8-69710043-H	8-69712043-H	nickel matt
8-6974022-H-22	8-6978032-H-22	8-69710042-H-22	8-69712042-H-22	white matt/chrome
8-6974022-H-02	8-6978032-H-02	8-69710042-H-02	8-69712042-H-02	black matt/chrome
8-6974022-H-23	8-6978032-H-23	8-69710042-H-23	8-69712042-H-23	anthracite matt/chr.

Farbig gepulverter Lichtbalken auf Anfrage. Color powdered metal rail on request.

- ▶ Ohne Zubehör. Bestell-Artikelnummern für Linse, Glas, Farbfilter und die Konfigurationsempfehlung (2) auf der Einklappseite!
- ▶ Without accessories: Order item-no. for lens, glass, color filter and the recommended Configuration (2) are on the fold-in page!

- 💡 G9 max. 33W ECO, optional LED Retrofit
- ⚡ G9 max. 33W ECO, LED Retrofit optional

- 💡 Leuchtmittelempfehlung: LED max. 3W/300lm/2.700K/dimmbar **G** Art. Nr. 8-205
- ⚡ bulb recommendation: LED max. 3W/300lm/2.700K/dimmable **G** Item No. 8-205

LED

450 mm L 2 Köpfe/heads G 4 x 12W, ~2.700k, ~3.600lm	850 mm L 3 Köpfe/heads G 6 x 12W, ~2.700k, ~5.400lm	1.050 mm L 4 Köpfe/heads G 8 x 12W, ~2.700k, ~7.200lm	1.250 mm L 4 Köpfe/heads G 8 x 12W, ~2.700k, ~7.200lm	Gehäuse body
8-6974021	8-6978031	8-69710041	8-69712041	chrome matt
8-6974022	8-6978032	8-69710042	8-69712042	chrome
8-6974023	8-6978033	8-69710043	8-69712043	nickel matt
8-6974022-22	8-6978032-22	8-69710042-22	8-69712042-22	white matt/chrome
8-6974022-02	8-6978032-02	8-69710042-02	8-69712042-02	black matt/chrome
8-6974022-23	8-6978032-23	8-69710042-23	8-69712042-23	anthracite matt/chr.

Farbig gepulverter Lichtbalken auf Anfrage. Color powdered metal rail on request.

- ▶ Ohne Zubehör. Bestell-Artikelnummern für Linse, Glas, Farbfilter und die Konfigurationsempfehlung (2) auf der Einklappseite!
- ▶ Without accessories: Order item-no. for lens, glass, color filter and the recommended Configuration (2) are on the fold-in page!

Sonderanfertigung:
Art-Nr. 8-600 Kürzung auf Maß
Item No. 8-600 Customized lengths

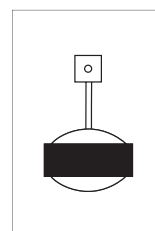
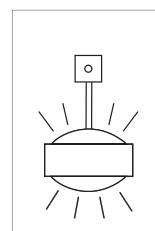
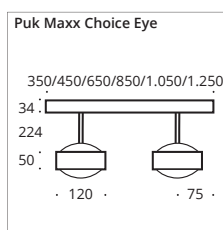

☐ Chrom Teile/
chrome parts
■ Gepulverte Teile/
powder-coating





Puk Mini Choice Side ø 80

Deckenleuchte, Hochvolt LED Power oder Hochvolt Halogen, dimmbar. Der Lichtbalken ist bestückt mit dreh- und schwenkbaren Puk Side Leuchten. Zur Direktmontage an der Decke.

Ceiling lamp, high voltage LED power or high voltage halogen, dimmable. The light bar is equipped with rotatable and swivelling Puk Mini Choice Side luminaires. For direct ceiling mounting.

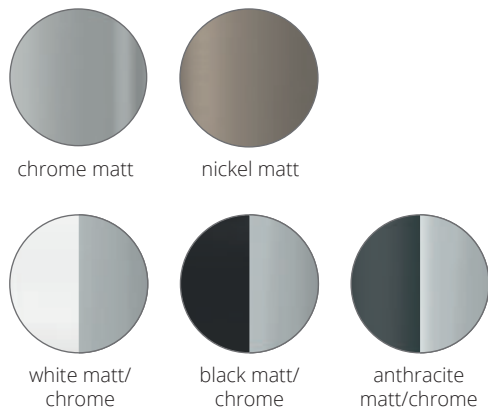

INDOOR

G9 Fassung

450 mm L 2 Köpfe/heads	850 mm L 3 Köpfe/heads	1.050 mm L 4 Köpfe/heads	1.250 mm L 4 Köpfe/heads	Gehäuse body
8-6284021-H	8-6288031-H	8-62810041-H	8-62812041-H	chrome matt
8-6284022-H	8-6288032-H	8-62810042-H	8-62812042-H	chrome
8-6284023-H	8-6288033-H	8-62810043-H	8-62812043-H	nickel matt
8-6284022-H-22	8-6288032-H-22	8-62810042-H-22	8-62812042-H-22	white matt/chrome
8-6284022-H-02	8-6288032-H-02	8-62810042-H-02	8-62812042-H-02	black matt/chrome
8-6284022-H-23	8-6288032-H-23	8-62810042-H-23	8-62812042-H-23	anthracite matt/chr.

Farbig gepulverter Lichtbalken auf Anfrage. Color powdered metal rail on request.

- ▶ Ohne Zubehör. Bestell-Artikelnummern für Linse, Glas, Farbfilter und die Konfigurationsempfehlung (2) auf der Einklappseite!
- ▶ Without accessories: Order item-no. for lens, glass, color filter and the recommended Configuration (2) are on the fold-in page!

- 💡 G9 max. 33W ECO, optional LED Retrofit
- 💡 G9 max. 33W ECO, LED Retrofit optional

- 💡 Leuchtmittelempfehlung: LED max. 3W/300lm/2.700K/dimmbar **G** Art. Nr. 8-205
- 💡 bulb recommendation: LED max. 3W/300Lm/2.700K/dimmable **G** Item No. 8-205

LED

450 mm L 2 Köpfe/heads G 4 x 8W, ~2.700k, ~2.400lm	850 mm L 3 Köpfe/heads G 6 x 8W, ~2.700k, ~3.600lm	1.050 mm L 4 Köpfe/heads G 8 x 8W, ~2.700k, ~4.800lm	1.250 mm L 4 Köpfe/heads G 8 x 8W, ~2.700k, ~4.800lm	Gehäuse body
8-6284021	8-6288031	8-62810041	8-62812041	chrome matt
8-6284022	8-6288032	8-62810042	8-62812042	chrome
8-6284023	8-6288033	8-62810043	8-62812043	nickel matt
8-6284022-22	8-6288032-22	8-62810042-22	8-62812042-22	white matt/chrome
8-6284022-02	8-6288032-02	8-62810042-02	8-62812042-02	black matt/chrome
8-6284022-23	8-6288032-23	8-62810042-23	8-62812042-23	anthracite matt/chr.

Farbig gepulverter Lichtbalken auf Anfrage. Color powdered metal rail on request.

- ▶ Ohne Zubehör. Bestell-Artikelnummern für Linse, Glas, Farbfilter und die Konfigurationsempfehlung (2) auf der Einklappseite!
- ▶ Without accessories: Order item-no. for lens, glass, color filter and the recommended Configuration (2) are on the fold-in page!

Sonderanfertigung:
Art-Nr. 8-600 Kürzung auf Maß
Item No. 8-600 Customized lengths

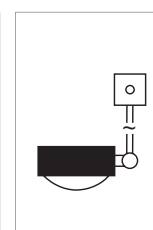
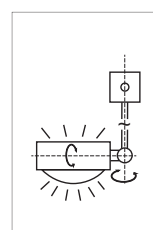
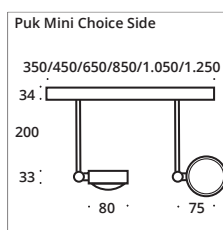

□ Chrom Teile/
chrome parts
■ Gepulverte Teile/
powder-coating





Puk Maxx Choice Side Ø 120

Deckenleuchte, Hochvolt LED Power oder Hochvolt Halogen, dimmbar. Der Lichtbalken ist bestückt mit dreh- und schwenkbaren Puk Maxx Side Leuchten. Zur Direktmontage an der Decke.

Ceiling lamp, high voltage LED power or high voltage halogen, dimmable. The light bar is equipped with rotatable and swivelling Puk Maxx Choice Side luminaires. For direct ceiling mounting.

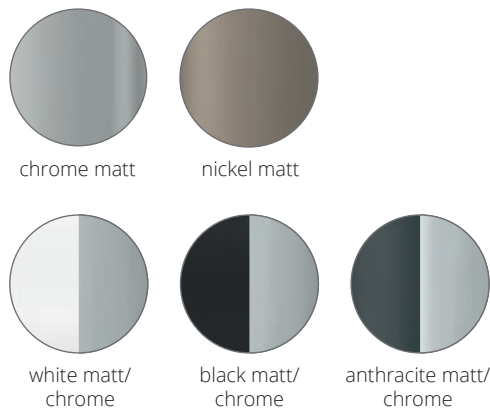

INDOOR

G9 Fassung

450 mm L 2 Köpfe/heads	850 mm L 3 Köpfe/heads	1.050 mm L 4 Köpfe/heads	1.250 mm L 4 Köpfe/heads	Gehäuse body
8-6584021-H	8-6588031-H	8-65810041-H	8-65812041-H	chrome matt
8-6584022-H	8-6588032-H	8-65810042-H	8-65812042-H	chrome
8-6584023-H	8-6588033-H	8-65810043-H	8-65812043-H	nickel matt
8-6584022-H-22	8-6588032-H-22	8-65810042-H-22	8-65812042-H-22	white matt/chrome
8-6584022-H-02	8-6588032-H-02	8-65810042-H-02	8-65812042-H-02	black matt/chrome
8-6584022-H-23	8-6588032-H-23	8-65810042-H-23	8-65812042-H-23	anthracite matt/chr.

Farbig gepulverter Lichtbalken auf Anfrage. Color powdered metal rail on request.

- ▶ Ohne Zubehör. Bestell-Artikelnummern für Linse, Glas, Farbfilter und die Konfigurationsempfehlung (2) auf der Einklappseite!
- ▶ Without accessories: Order item-no. for lens, glass, color filter and the recommended Configuration (2) are on the fold-in page!

- 💡 G9 max. 33W ECO, optional LED Retrofit
- 💡 G9 max. 33W ECO, LED Retrofit optional

- 💡 Leuchtmittelempfehlung: LED max. 3W/300lm/2.700K/dimmbar **G** Art. Nr. 8-205
- 💡 bulb recommendation: LED max. 3W/300lm/2.700K/dimmable **G** Item No. 8-205

LED

450 mm L 2 Köpfe/heads G 4 x 12W, ~2.700k, ~3.600lm	850 mm L 3 Köpfe/heads G 6 x 12W, ~2.700k, ~5.400lm	1.050 mm L 4 Köpfe/heads G 8 x 12W, ~2.700k, ~7.200lm	1.250 mm L 4 Köpfe/heads G 8 x 12W, ~2.700k, ~7.200lm	Gehäuse body
8-6584021	8-6588031	8-65810041	8-65812041	chrome matt
8-6584022	8-6588032	8-65810042	8-65812042	chrome
8-6584023	8-6588033	8-65810043	8-65812043	nickel matt
8-6584022-22	8-6588032-22	8-65810042-22	8-65812042-22	white matt/chrome
8-6584022-02	8-6588032-02	8-65810042-02	8-65812042-02	black matt/chrome
8-6584022-23	8-6588032-23	8-65810042-23	8-65812042-23	anthracite matt/chr.

Farbig gepulverter Lichtbalken auf Anfrage. Color powdered metal rail on request.

- ▶ Ohne Zubehör. Bestell-Artikelnummern für Linse, Glas, Farbfilter und die Konfigurationsempfehlung (2) auf der Einklappseite!
- ▶ Without accessories: Order item-no. for lens, glass, color filter and the recommended Configuration (2) are on the fold-in page!

Sonderanfertigung:
Art-Nr. 8-600 Kürzung auf Maß
Item No. 8-600 Customized lengths

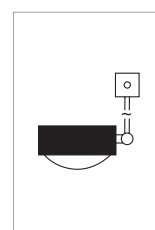
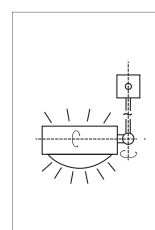
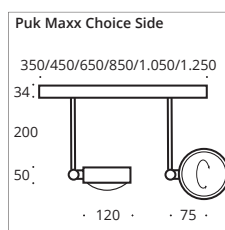

□ Chrom Teile/
chrome parts
■ Gepulverte Teile/
powder-coating





Paxx ø 150

Diese puristisch moderne LED Deckenleuchte in Bauhaus inspiriertem Design ist ein wahrer Hingucker. Die 150mm Durchmesser Linse (optional ist auch ein mattes Glas für sanft gestreutes Licht erhältlich) wirkt freischwebend auf der Metallbasis. Mit ihren 15 Watt und 2.700 Kelvin bietet die Paxx eine gigantische Lichtausbeute und macht sie somit einsetzbar für den Privat- und für den Objektbereich. Eine Innovation dieser Leuchte ist die leichte und schnelle Montage durch ein einfaches Clip-System.

This puristic modern LED ceiling light in Bauhaus-inspired design is a real eye-catcher. The 150mm diameter lens (a matt glass for softly diffused light is also available as an option) appears free-floating on the metal base. With its 15 watts and 2,700 Kelvin, the Paxx offers a gigantic light output, making it suitable for both private and industrial use. An innovation of this luminaire is the easy and quick mounting by a simple clip system.

INDOOR



Paxx White Edition mit klarer Linse und weiß gepulverten Clips
Paxx white Edition with clear lens and white powder-coated clips



Paxx chrom
mit matten
Linse und
Clips in Nickel



Paxx schwarz
mit matten
Glas und Clips
in Nickel



Black Edition
gepulverter Clip



White Edition
gepulverter Clip

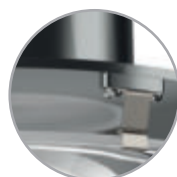

chrome matt
Clip in Nickel



chrome
Clip in Nickel

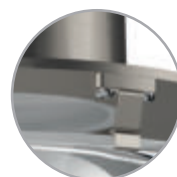

nickel matt
Clip in Nickel

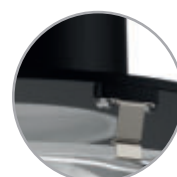

black matt
Clip in Nickel



white matt
Clip in Nickel

Paxx 2.700K LED G 15W, ~90CRI, ~1.500lm	ø x H ø x H in mm	Gehäuse body
● 7-90100-BE	150 x 57	black matt Black Edition
○ 7-90100-WE	150 x 57	white matt White Edition
● 7-90101	150 x 57	chrome matt/nickel
● 7-90102	150 x 57	chrome/nickel
● 7-90103	150 x 57	nickel matt
● 7-90102-02	150 x 57	black matt/nickel
● 7-90102-22	150 x 57	white matt/nickel
● 7-90102-23	150 x 57	anthracite matt/nickel

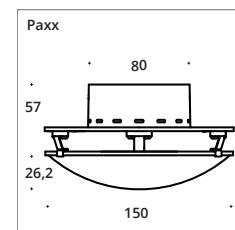

Art. Nr. item no.	Einsatz/Zubehör insert/equipment	Beschreibung description
2-5036 2-5036-s	Linse klar, clear lens Linse matt, frosted lens	Borosilikatglas klar, Borosilikatglass clear Borosilikatglas einseitig mattiert, Borosilikatglass frosted on one side
2-5037	Glas matt, frosted glass	Borosilikatglas beidseitig mattiert, passt nicht unter Linse Borosilikatglass frosted on both sides, doesn't fit under lens

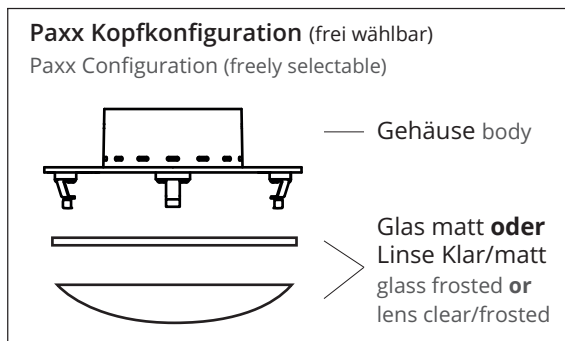





Allround ø 120/160/240

Diese Aufbauleuchte wurde für den Wand- und Deckeneinsatz konstruiert, dimmbar. Mit zwei kardanisch aufeinander abgestimmten Gelenken, lassen sich die LED Leuchtenköpfe um über 360 Grad drehen. Mit drei Leuchtenkopfdurchmessern (ø120mm/8W/920lm, ø160mm/12W/1300lm, ø240mm/16W/1600lm, durchgängig 2700k), sind die Leuchten für viele Anwendungen im Privat- oder Objektbereich planbar.

This surface-mounted luminaire was designed for wall and ceiling use, dimmable. With two gimbal-mounted joints, the LED luminaire heads can be rotated through more than 360 degrees. With three luminaire head diameters (ø120mm/8W/920lm, ø160mm/12W/1300lm, ø240mm/16W/1600lm, 2700k throughout all models), the luminaires can be integrated for many applications in the residential and project sector.

INDOOR

Allround in Bewegung (Wandbefestigung) Allround in motion (wall mounting)



Allround in Bewegung (Deckenbefestigung) Allround in motion (ceiling mounting)



chrome

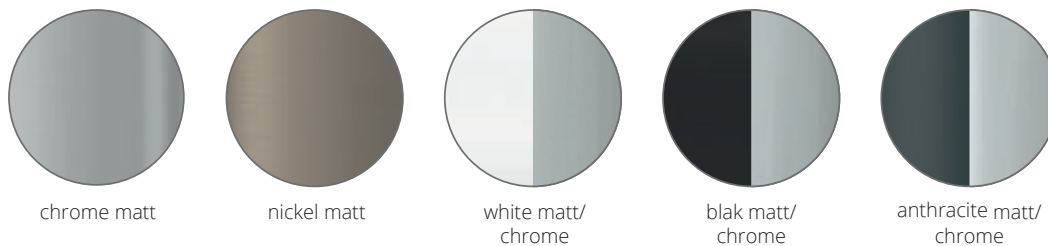

chrome matt

nickel matt

white matt/
chrome

black matt/
chrome

anthracite matt/
chrome

□ Chrom Teile/
chrome parts
■ Gepulverte Teile/
powder-coating

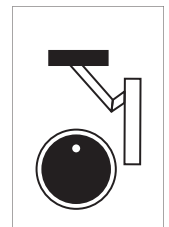

Allround 120 mm ø	Allround 160 mm ø	Allround 240 mm ø	Gehäuse body
LED: G 8 Watt, ~2.700k ~920 lm	LED: G 12 Watt, ~2.700k ~1.300 lm	LED: G 16 Watt, ~2.700k ~1.600 lm	
● 7-2201211 ● 7-2201212 ● 7-2201213 ● 7-2201212-22 ● 7-2201212-02 ● 7-2201212-23	● 7-2201611 ● 7-2201612 ● 7-2201613 ● 7-2201612-22 ● 7-2201612-02 ● 7-2201612-23	● 7-2202411 ● 7-2202412 ● 7-2202413 ● 7-2202412-22 ● 7-2202412-02 ● 7-2202412-23	chrome matt chrome nickel matt white matt/chrome black matt/chrome anthracite matt/chr.

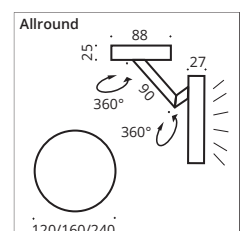
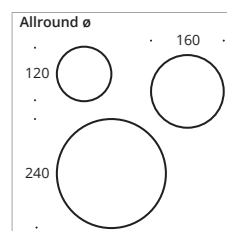





Allround Flat ø 120/160/240

Diese flache LED Aufbauleuchte wurde für den Deckeneinsatz konstruiert, dimmbar. Mit drei Leuchtenkopfdurchmessern (ø120mm/8W/920lm, ø160mm/12W/1300lm, ø240mm/16W/1600lm, durchgängig 2700k), lassen sich die Leuchten für viele Anwendungen im Privat- oder Objektbereich einplanen.

This flat surface-mounted LED luminaire was designed for wall and ceiling use, dimmable. With three luminaire head diameters (ø120mm/8W/920lm, ø160mm/12W/1300lm, ø240mm/16W/1600lm, 2700k throughout all models), the luminaires can be planned for many applications in the private and contract sector.

INDOOR

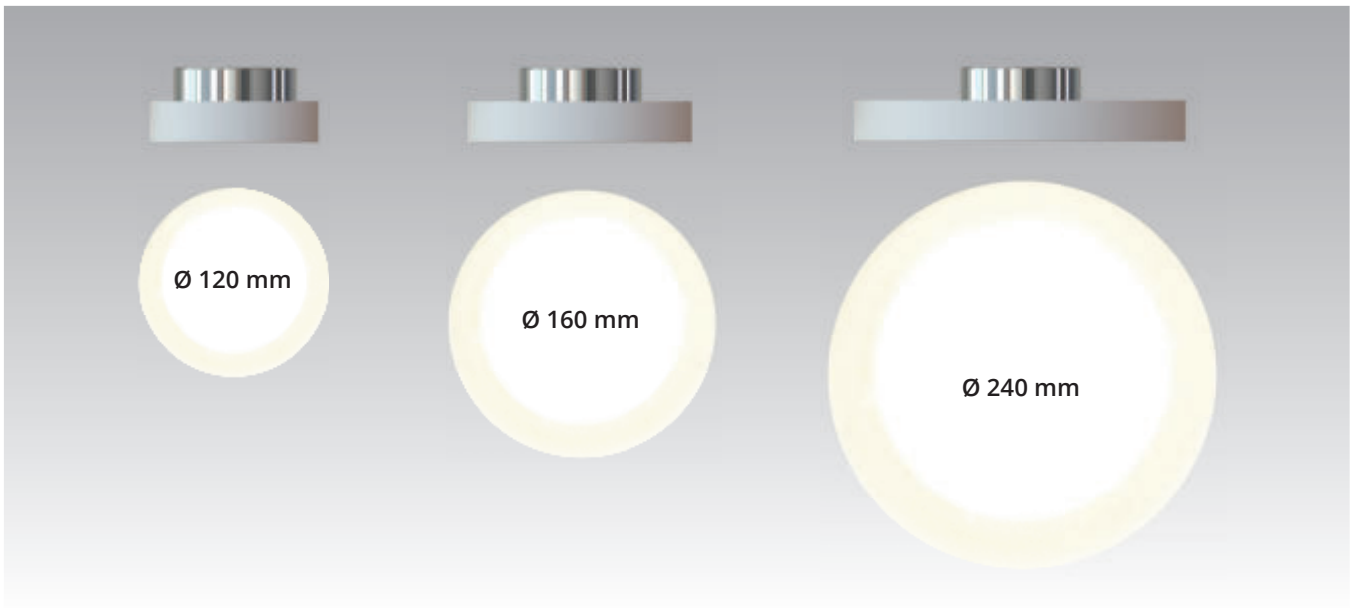

Allround 120 mm ø	Allround 160 mm ø	Allround 240 mm ø	Gehäuse body
LED: G 8 Watt, ~2.700k ~920 lm	LED: G 12 Watt, ~2.700k ~1.300 lm	LED: G 16 Watt, ~2.700k ~1.600 lm	
● 7-2221211	7-2221611	7-2222411	chrome matt
● 7-2221212	7-2221612	7-2222412	chrome
● 7-2221213	7-2221613	7-2222413	nickel matt
● 7-2221212-22	7-2221612-22	7-2222412-22	white matt/chrome
● 7-2221212-02	7-2221612-02	7-2222412-02	black matt/chrome
● 7-2221212-23	7-2221612-23	7-2222412-23	anthracite matt/chr.

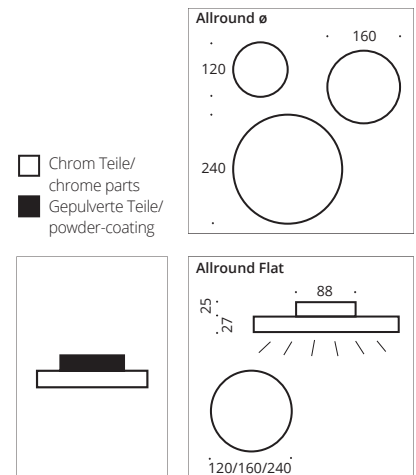

CE LED C IP20 BC (s.S 6-7/s.p. 6-7)





Foxx Round \varnothing 200/300/400/500

Mit 20 mm ist die Round eine sensationell flache LED Deckenleuchte in den Durchmessern 200/300/400/500 mm. Als Auf- oder Einbauleuchte passt sie sich allen Stilrichtungen an. Mit der eingesetzten LED Hochvolttechnik heißt es nur noch »plug and light«. Auch als Outdoor Variante erhältlich (IP44).

With an unbelievable height of 20 mm the slim LED lamp can be mounted on ceilings. Diameter are available in 200/300/400/500 mm. As built-in or surface mounted luminaire for all kind of lighting requirements. With its high power LED assembly is as easy as possible. "Plug and light". Also available for Outdoor (IP44) areas.

INDOOR

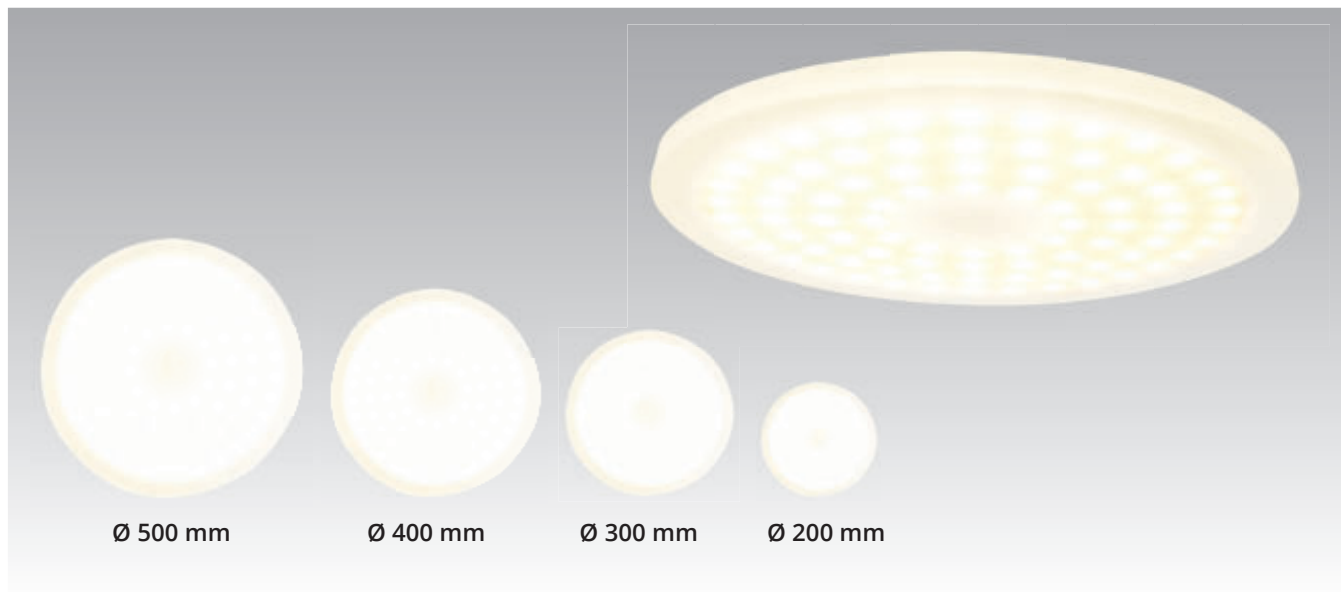

Foxx Round 200/300/400/500 Wall & Ceiling (Aufbauleuchte/surface mounting)

Round 200 mm \varnothing LED: G 10 Watt, ~2.700k ~700lm	Round 300 mm \varnothing LED: G 14 Watt, ~2.700k ~1.260lm	Round 400 mm \varnothing LED: G 22 Watt, ~2.700k ~1.980lm	Round 500 mm \varnothing LED: G 33 Watt, ~2.700k ~2.970lm	Gehäuse body
7-46320010	7-46330010	7-46340010	7-46350010	alueloxiert/ frosted solid acrylic

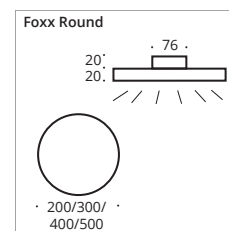

Foxx Round 200/300/400/500 Fit In (Einbauleuchte/recessed fitting)

Round 200 mm \varnothing LED: G 10 Watt, ~2.700k ~700lm	Round 300 mm \varnothing LED: G 14 Watt, ~2.700k ~1.260lm	Round 400 mm \varnothing LED: G 22 Watt, ~2.700k ~1.980lm	Round 500 mm \varnothing LED: G 33 Watt, ~2.700k ~2.970lm	Gehäuse body
7-46420010	7-46430010	7-46440010	7-46450010	alueloxiert/ frosted solid acrylic

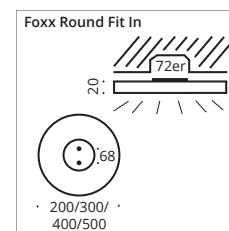





Foxx Cube ø 200/300/400/500

Mit 20 mm ist die Cube eine sensationell flache LED Deckenleuchte in den Durchmessern 200/300/400/500 mm. Als Auf- oder Einbauleuchte passt sie sich allen Stilrichtungen an. Mit der eingesetzten LED Hochvolttechnik heißt es nur noch »plug and light«. Auch als Outdoor Variante erhältlich (IP44).

With an unbelievable height of 20 mm the slim LED lamp can be mounted on ceilings. Diameter are available in 200/300/400/500 mm. As built-in or surface mounted luminaire for all kind of lighting requirements. With its high power LED assembly is as easy as possible. "Plug and light". Also available for Outdoor (IP44) areas.

INDOOR

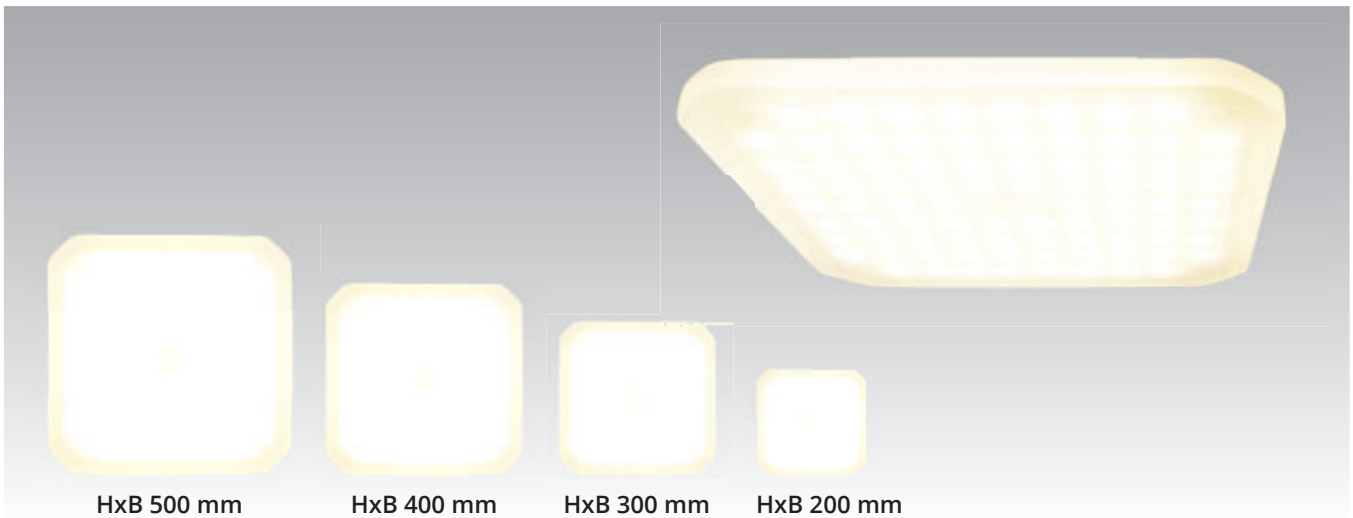

Foxx Cube 200/300/400/500

Wall & Ceiling (Aufbauleuchte/surface mounting)

Cube	Cube	Cube	Cube	Gehäuse
200 x 200 mm	300 x 300 mm	400 x 400 mm	500 x 500 mm	body
LED: G 10 Watt, ~2.700k ~700lm	LED: G 14 Watt, ~2.700k ~1.260lm	LED: G 22 Watt, ~2.700k ~1.980lm	LED: G 33 Watt, ~2.700k ~2.970lm	
7-46120010	7-46130010	7-46140010	7-46150010	alueloxiert/ frosted solid acrylic

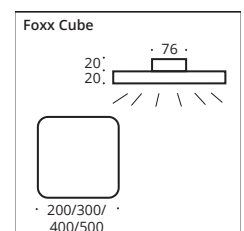

Foxx Cube 200/300/400/500

Fit In (Einbauleuchte/recessed fitting)

Cube	Cube	Cube	Cube	Gehäuse
200 x 200 mm	300 x 300 mm	400 x 400 mm	500 x 500 mm	body
LED: G 10 Watt, ~2.700k ~700lm	LED: G 14 Watt, ~2.700k ~1.260lm	LED: G 22 Watt, ~2.700k ~1.980lm	LED: G 33 Watt, ~2.700k ~2.970lm	
7-46220010	7-46230010	7-46240010	7-46250010	alueloxiert/ frosted solid acrylic

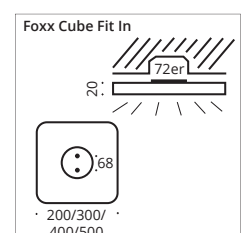





Sun ø 90/130/210

Der Leuchtenkopf der LED Deckenleuchte Sun Ceiling lässt sich in alle Richtungen über ein Kugelgelenk schwenken. Sie ist in den Durchmessern 90/130/210 mm als Up- oder Downlight wählbar. Ob direkt oder Indirekt, lässt sich das Licht dorthin lenken, wo es benötigt wird. Auch als Outdoorleuchte erhältlich in IP44.

The luminaire head of the Sun Ceiling LED luminaires can be swivelled in all directions via a ball joint. It is available in the diameters 90/130/210 mm as uplight or downlight. Whether direct or indirect, the light can be directed to where it is needed. Also available as an outdoor version (IP44).

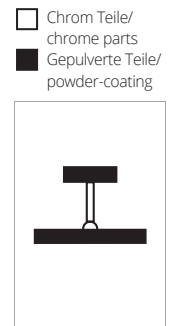
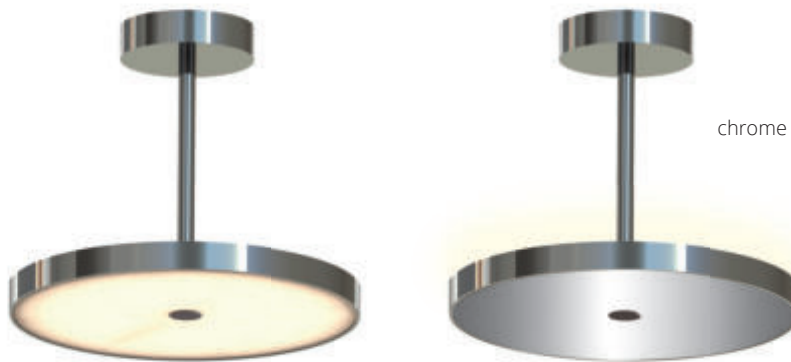
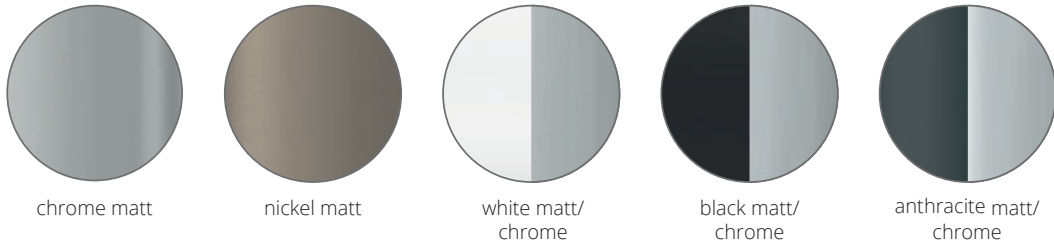

Indoor Sun – Up Light

Up Light	Up Light	Up Light	Gehäuse body
Kopf/head: ø 90 mm Baldachin: ø 65 mm LED: G 8 Watt, ~2.700k, ~920 lm	Kopf/head: ø 130 mm Baldachin: ø 65 mm LED: G 12 Watt, ~2.700k, ~1.300 lm	Kopf/head: ø 210 mm Baldachin: ø 80 mm LED: G 16 Watt, ~2.700k, ~1.600 lm	
<ul style="list-style-type: none"> ● 7-3259011 ● 7-3259012 ● 7-3259013 ● 7-3259012-22 ● 7-3259012-02 ● 7-3259012-23 	<ul style="list-style-type: none"> ● 7-32513011 ● 7-32513012 ● 7-32513013 ● 7-32513012-22 ● 7-32513012-02 ● 7-32513012-23 	<ul style="list-style-type: none"> ● 7-32521011 ● 7-32521012 ● 7-32521013 ● 7-32521012-22 ● 7-32521012-02 ● 7-32521012-23 	<ul style="list-style-type: none"> ● chrome matt ● chrome ● nickel matt ● white matt/chrome ● black matt/chrome ● anthracite matt/chr.

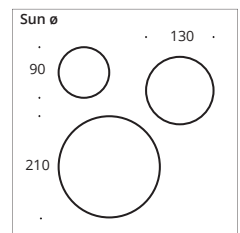

Indoor Sun – Down Light

Down Light	Down Light	Down Light	Gehäuse body
Kopf/head: ø 90 mm Baldachin: ø 65 mm LED: G 8 Watt, ~2.700k, ~920 lm	Kopf/head: ø 130 mm Baldachin: ø 65 mm LED: G 12 Watt, ~2.700k, ~1.300 lm	Kopf/head: ø 210 mm Baldachin: ø 80 mm LED: G 16 Watt, ~2.700k, ~1.600 lm	
<ul style="list-style-type: none"> ● 7-3269011 ● 7-3269012 ● 7-3269013 ● 7-3269012-22 ● 7-3269012-02 ● 7-3269012-23 	<ul style="list-style-type: none"> ● 7-32613011 ● 7-32613012 ● 7-32613013 ● 7-32613012-22 ● 7-32613012-02 ● 7-32613012-23 	<ul style="list-style-type: none"> ● 7-32621011 ● 7-32621012 ● 7-32621013 ● 7-32621012-22 ● 7-32621012-02 ● 7-32621012-23 	<ul style="list-style-type: none"> ● chrome matt ● chrome ● nickel matt ● white matt/chrome ● black matt/chrome ● anthracite matt/chr.

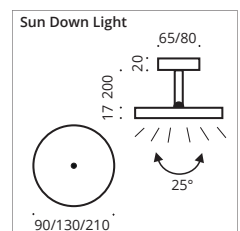
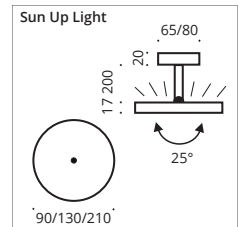

INDOOR



Sun Ceiling Choice downlight



Sun Ceiling Choice \varnothing 90/130/210 downlight

Lichtbalken für Direktmontage an der Decke. Bestückt mit Sun Ceiling Leuchten, Kopfdurchmesser 90, 130 oder 210 mm. Deckenleuchten aus der Top Light Serie.

Light bar for direct mounting on the ceiling. Equipped with Sun Ceiling luminaires, diameter 90, 130 or 210 mm. Ceiling light from the Top Light series.

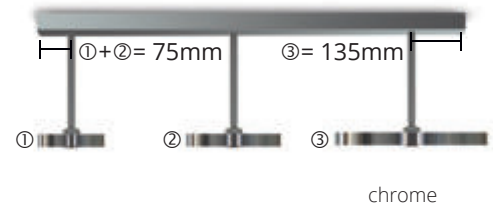
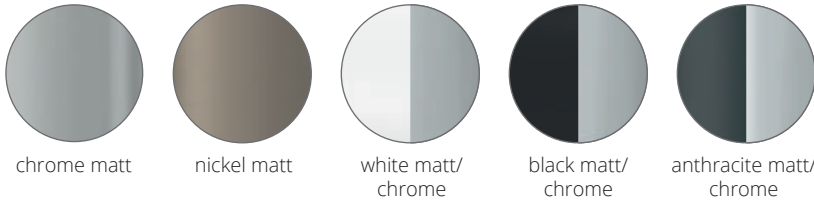

INDOOR

Sun Ceiling \varnothing 90 mm downlight

450 mm L 2 Köpfe/heads LED: G 16W ~1.840lm ~2.700k	650 mm L 3 Köpfe/heads LED: G 24W ~2.760lm ~2.700k	1.050 mm L 4 Köpfe/heads LED: G 32W ~3.680lm ~2.700k	1.250 mm L 4 Köpfe/heads LED: G 32W ~3.680lm ~2.700k	Gehäuse body
8-72904021	8-72906031	8-729010041	8-729012041	chrome matt
8-72904022	8-72906032	8-729010042	8-729012042	chrome
8-72904023	8-72906033	8-729010043	8-729012043	nickel matt
8-72904022-22	8-72906032-22	8-729010042-22	8-729012042-22	white matt/chr.
8-72904022-02	8-72906032-02	8-729010042-02	8-729012042-02	black matt/chr.
8-72904022-23	8-72906032-23	8-729010042-23	8-729012042-23	anthracite matt/chr.

Farbig gepulverter Lichtbalken auf Anfrage. Color powdered metal rail on request.

Sun Ceiling \varnothing 130 mm downlight

450 mm L 2 Köpfe/heads LED: G 24W ~2.600lm ~2.700k	650 mm L 3 Köpfe/heads LED: G 36W ~3.900lm ~2.700k	1.050 mm L 4 Köpfe/heads LED: G 48W ~5.200lm ~2.700k	1.250 mm L 4 Köpfe/heads LED: G 48W ~5.200lm ~2.700k	Gehäuse body
8-721304021	8-721306031	8-7213010041	8-7213012041	chrome matt
8-721304022	8-721306032	8-7213010042	8-7213012042	chrome
8-721304023	8-721306033	8-7213010043	8-7213012043	nickel matt
8-721304022-22	8-721306032-22	8-7213010042-22	8-7213012042-22	white matt/chr.
8-721304022-02	8-721306032-02	8-7213010042-02	8-7213012042-02	black matt/chr.
8-721304022-23	8-721306032-23	8-7213010042-23	8-7213012042-23	anthracite matt/chr.

Farbig gepulverter Lichtbalken auf Anfrage. Color powdered metal rail on request.

Sun Ceiling \varnothing 210 mm downlight

850 mm L 2 Köpfe/heads LED: G 32W ~3.200lm ~2.700k	1.050 mm L 3 Köpfe/heads LED: G 48W ~4.800lm ~2.700k	1.250 mm L 3 Köpfe/heads LED: G 48W ~4.800lm ~2.700k	Gehäuse body
8-722108031	8-7221010041	8-7221012041	chrome matt
8-722108032	8-7221010042	8-7221012042	chrome
8-722108033	8-7221010043	8-7221012043	nickel matt
8-722108032-22	8-7221010042-22	8-7221012042-22	white matt/chr.
8-722108032-02	8-7221010042-02	8-7221012042-02	black matt/chr.
8-722108032-23	8-7221010042-23	8-7221012042-23	anthracite matt/chr.

Farbig gepulverter Lichtbalken auf Anfrage. Color powdered metal rail on request.

Sonderanfertigung:

Art-Nr. 8-600 Kürzung auf Maß

Item No. 8-600 Customized lengths

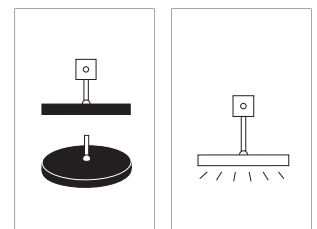
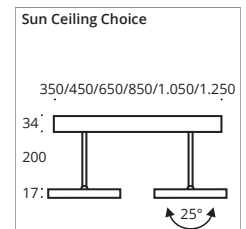

□ Chrom Teile/
chrome parts
■ Gepulverte Teile/
powder-coating

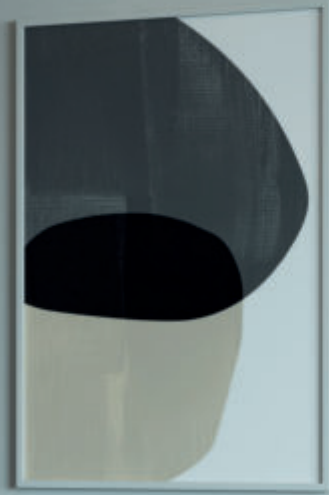



Sun Ceiling Choice \varnothing 90/130/210 uplight

Lichtbalken für Direktmontage an der Decke. Bestückt mit Sun Ceiling Leuchten, Kopfdurchmesser 90, 130 oder 210 mm. Deckenleuchten aus der Top Light Serie.

Light bar for direct mounting on the ceiling. Equipped with Sun Ceiling luminaires, diameter 90, 130 or 210 mm. Ceiling light from the Top Light series.

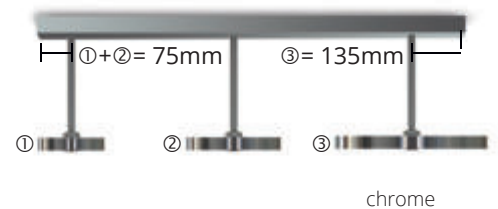
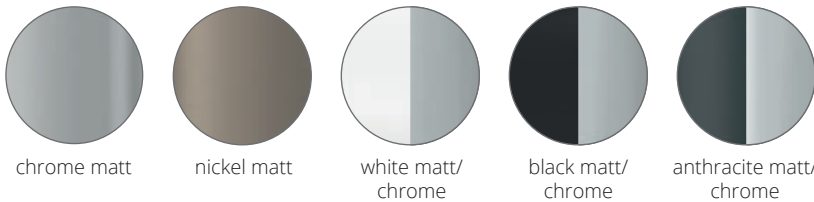

INDOOR

Sun Ceiling \varnothing 90 mm uplight

450 mm L 2 Köpfe/heads LED: G 16W ~1.840lm ~2.700k	650 mm L 3 Köpfe/heads LED: G 24W ~2.760lm ~2.700k	1.050 mm L 4 Köpfe/heads LED: G 32W ~3.680lm ~2.700k	1.250 mm L 4 Köpfe/heads LED: G 32W ~3.680lm ~2.700k	Gehäuse body
8-73904021	8-73906031	8-739010041	8-739012041	chrome matt
8-73904022	8-73906032	8-739010042	8-739012042	chrome
8-73904023	8-73906033	8-739010043	8-739012043	nickel matt
8-73904022-22	8-73906032-22	8-739010042-22	8-739012042-22	white matt/chr.
8-73904022-02	8-73906032-02	8-739010042-02	8-739012042-02	black matt/chr.
8-73904022-23	8-73906032-23	8-739010042-23	8-739012042-23	anthracite matt/chr.

Farbig gepulverter Lichtbalken auf Anfrage. Color powdered metal rail on request.

Sun Ceiling \varnothing 130 mm uplight

450 mm L 2 Köpfe/heads LED: G 24W ~2.600lm ~2.700k	650 mm L 3 Köpfe/heads LED: G 36W ~3.900lm ~2.700k	1.050 mm L 4 Köpfe/heads LED: G 48W ~5.200lm ~2.700k	1.250 mm L 4 Köpfe/heads LED: G 48W ~5.200lm ~2.700k	Gehäuse body
8-731304021	8-731306031	8-7313010041	8-7313012041	chrome matt
8-731304022	8-731306032	8-7313010042	8-7313012042	chrome
8-731304023	8-731306033	8-7313010043	8-7313012043	nickel matt
8-731304022-22	8-731306032-22	8-7313010042-22	8-7313012042-22	white matt/chr.
8-731304022-02	8-731306032-02	8-7313010042-02	8-7313012042-02	black matt/chr.
8-731304022-23	8-731306032-23	8-7313010042-23	8-7313012042-23	anthracite matt/chr.

Farbig gepulverter Lichtbalken auf Anfrage. Color powdered metal rail on request.

Sun Ceiling \varnothing 210 mm uplight

850 mm L 2 Köpfe/heads LED: G 32W ~3.200lm ~2.700k	1.050 mm L 3 Köpfe/heads LED: G 48W ~4.800lm ~2.700k	1.250 mm L 3 Köpfe/heads LED: G 48W ~4.800lm ~2.700k	Gehäuse body
8-732108031	8-7321010041	8-7321012041	chrome matt
8-732108032	8-7321010042	8-7321012042	chrome
8-732108033	8-7321010043	8-7321012043	nickel matt
8-732108032-22	8-7321010042-22	8-7321012042-22	white matt/chr.
8-732108032-02	8-7321010042-02	8-7321012042-02	black matt/chr.
8-732108032-23	8-7321010042-23	8-7321012042-23	anthracite matt/chr.

Farbig gepulverter Lichtbalken auf Anfrage. Color powdered metal on request.

Sonderanfertigung:

Art-Nr. 8-600 Kürzung auf Maß

Item No. 8-600 Customized lengths



☐ Chrom Teile/
chrome parts
■ Gepulverte Teile/
powder-coating

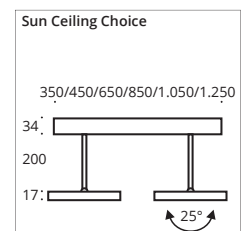
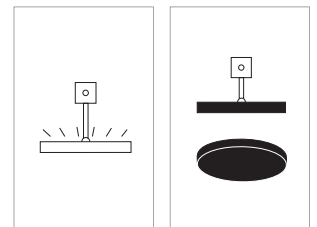





Only Choice Ceiling

Geradlinige LED Leuchte für die Direktmontage mit Prismen-
diffusor. Für den Objekt- und Privatbereich der Officeanwen-
dung.

Linear LED luminaire for direct mounting with prismatic dif-
fuser. For project and residential use.

INDOOR

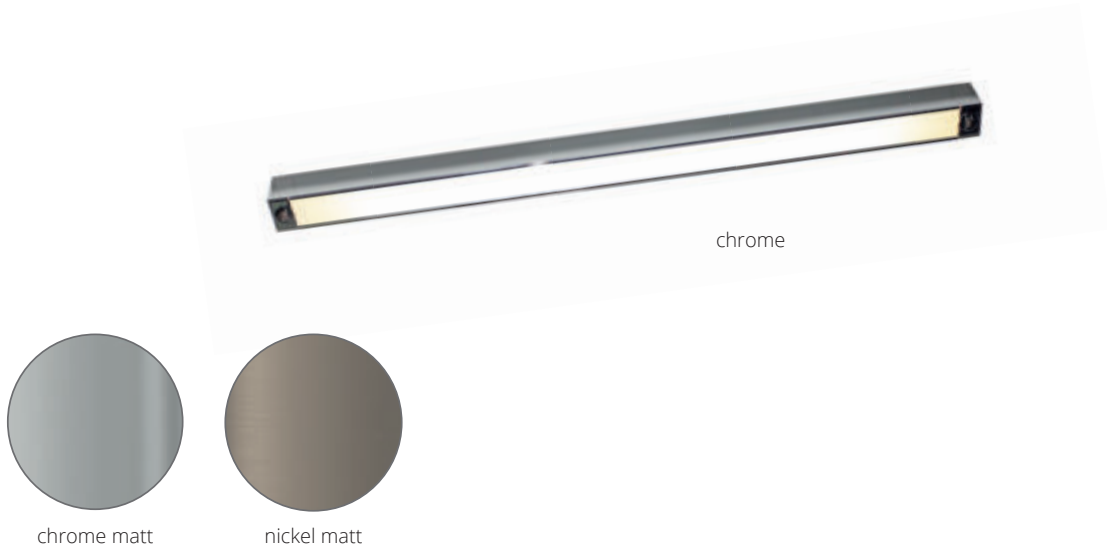

Only Choice Direktmontage

350 mm L	600 mm L	800 mm L	1.250 mm L	Gehäuse body
LED: G 9W, ~720lm, ~3.000k	LED: G 13,5W, ~1080lm, ~3.000k	LED: G 22,5W, ~1800lm, ~3.000k	LED: G 36W, ~2880lm, ~3.000k	
8-601351	8-601651	8-601951	8-6011251	chrome matt
8-601352	8-601652	8-601952	8-6011252	chrome
8-601353	8-601653	8-601953	8-6011253	nickel matt

Farbig gepulverter Lichtbalken auf Anfrage. Color powdered metal rail on request.

Bitte hinter die Art.-Nr. den Buchstaben (A-C) der gewünschten Deckenvariante hängen.
Durch Versetzen der Endkappen ist jede Variante montierbar.

Please attach the character (A-C) to the item no. of the ceiling variant you have chosen.
With turning the endpieces the lamp can be mounted in every position.



Sonderanfertigung:

Art-Nr. 8-600 Kürzung auf Maß

Item No. 8-600 Customized lengths

Montagevarianten:

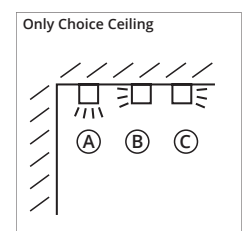
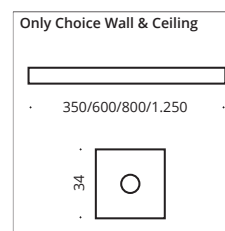





Dela

Deckenleuchten für einen idealen Einsatz in Fluren und Bädern. Gefertigt aus Mattglas bietet sie ein weiches Rundumlicht. Erhältlich mit verschiedenen Fassungen.

Ceiling lights for ideal use in hallways and bathrooms. Made of frosted glass, it offers a soft all-round light. Available in different versions.

INDOOR

Reflektor "Option", baffle "option"



Richtungsweisend:

Aluminium-Hochleistungsreflektor, einfache Montage durch Einschub in den Glastubus.

Multi directional:

High performance baffle. Easy installation: slides into the tube.



Dela



Dela Short



Dela Short Spot mit Abdeckplatte/with cover panel

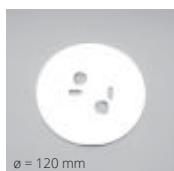

Abdeckplatte, passend für Dela und Dela-short/Spot, Sicht- und Hitzeschutz für Holzdecken und Hohlraum Dosen, superflach - nur 2 mm, verdeckte Montage.

Cover panel for Dela and Dela-short/Spot. Screen and heat protection for wooden ceilings and cavity outlets. Super flat - only 2 mm. For hidden mounting.

E27 Fassung	Art.Nr. item no.	B x H w x h in mm	Ausführung design
Dela	4-07651	65 x 180	satiniertes Glas frosted glass

E27 max. 42W, optional LED Retrofit
E27 max. 42W, LED Retrofit optional

Leuchtmittlempfehlung: LED max. 9W/800lm/2.700K **G** Art. Nr. 8-309
bulb recommendation: LED max. 9W/800Lm/2.700K **G** Item No. 8-309

G9 Fassung	Art.Nr. item no.	B x H w x h in mm	Ausführung design
Dela Short	4-06650	65 x 80	satiniertes Glas frosted glass

G9 max. 33W, optional LED Retrofit
G9 max. 33W, LED Retrofit optional

Leuchtmittlempfehlung: LED max. 3W/300lm/2.700K/dimmbar **G** Art. Nr. 8-205
bulb recommendation: LED max. 3W/300Lm/2.700K/dimmable **G** Item No. 8-205

GU10 Fassung	Art.Nr. item no.	B x H w x h in mm	Ausführung design
Dela Short Spot	7-06659	65 x 80	Deckenstrahler ceiling spotlight

GU10 max. 35W, optional LED Retrofit
GU10 max. 35W, LED Retrofit optional

Leuchtmittlempfehlung: LED max. 4W/230lm/2.700K **G** Art. Nr. 8-211
bulb recommendation: LED max. 4W/230Lm/2.700K **G** Item No. 8-211

Modell model	Art.Nr. item no.	Ausführung design
"Option"	9-200	Reflektor für Dela baffle for Dela
"Option"	9-201	Reflektor für Dela Short baffle for Dela Short
Abdeckplatte, verdeckte Montage hidden cover panel	9-12002 9-12009 9-12002-22 9-12002-02	chrome nickel matt white matt black matt

CE R LED C IP20 BC (s.S 6-7/s.p. 6-7)

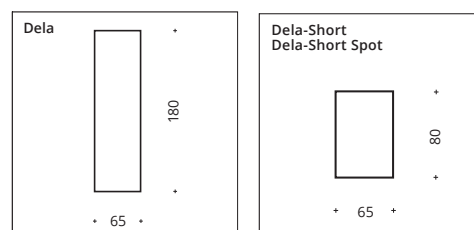





Dela Box

Deckenleuchten für einen idealen Einsatz in Fluren und Bädern. Gefertigt aus Mattglas bietet sie ein weiches Rundum-Licht. Erhältlich mit verschiedenen Fassungen. Aufbausockel wahlweise in chrom oder nickelmatt.

Ceiling lights for ideal use in hallways and bathrooms. Made of frosted glass, it offers a soft all-round light. Available in different versions. Mounting base alternatively in chrome or nickel matt design.

INDOOR



Dela Box Short Spot

Reflektor "Option", baffle "option"

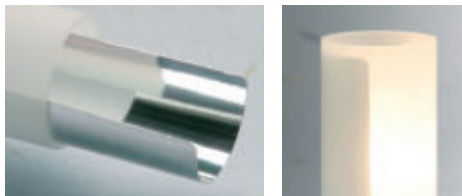

Richtungsweisend:

Aluminium-Hochleistungsreflektor, einfache Montage durch Einschub in den Glastubus.

Multi directional:

High performance baffle. Easy installation: slides into the tube.



Dela Box Short & Box

E27 Fassung	Art.Nr. item no.	Ausführung design
Dela Box	4-04651	nickel matt chrome
"Option"	4-04652	Reflektor, baffle
"Option"	9-200	Reflektor, baffle
E27 max. 42W, optional LED Retrofit		
E27 max. 42W, LED Retrofit optional		
Leuchtmittelempfehlung: LED max.		
9W/800lm/2.700K Art. Nr. 8-309		
bulb recommendation: LED max.		
9W/800lm/2.700K Item No. 8-309		

G9 Fassung	Art.Nr. item no.	Ausführung design
Dela Box Short	4-05651	nickel matt chrome
"Option"	4-05652	Reflektor, baffle
"Option"	9-201	Reflektor, baffle
G9 max. 33W, optional LED Retrofit		
G9 max. 33W, LED Retrofit optional		
Leuchtmittelempfehlung: LED max.		
3W/300lm/2.700K/dimmbar Art. Nr. 8-205		
bulb recommendation: LED max. 3W/300lm/2.700K/		
dimmable Item No. 8-205		

GU10 Fassung	Art.Nr. item no.	Ausführung design
Dela Box	4-05658	nickel matt chrome
Short Spot	4-05659	chrome
GU10 max. 35W, optional LED Retrofit		
GU10 max. 35W, LED Retrofit optional		
Leuchtmittelempfehlung: LED max.		
4W/230lm/2.700K Art. Nr. 8-211		
bulb recommendation: LED max. 4W/230Lm/2.700K		
Item No. 8-211		

LED	Art.Nr. item no.	Ausführung design
4W, ~390lm, ~3.000k		
Dela Box LED	4-04651-LED	nickel matt chrome
Dela Box LED	4-04652-LED	chrome
Dela Box Short LED	4-05651-LED	nickel matt chrome
Dela Box Short LED	4-05652-LED	chrome

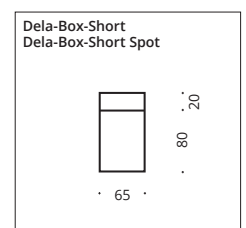
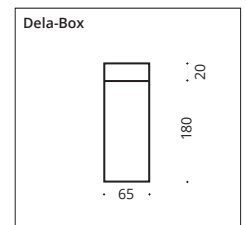





Quadro

Deckenleuchten für einen idealen Einsatz in Fluren und Bädern. Gefertigt aus Mattglas bietet sie ein weiches Rundum-Licht. Erhältlich mit verschiedenen Fassungen.

Ceiling lights for ideal use in hallways and bathrooms. Made of frosted glass, it offers a soft all-round light. Available in different versions.

INDOOR



Quadro Short & Quadro



Quadro Short Spot

E27 Fassung	Art.Nr. item no.	Ausführung design
Quadro	4-07621	satinieretes Glas, frosted glass

- E27 max. 42W, optional LED Retrofit
- E27 max. 42W, LED Retrofit optional
- Leuchtmittlempfehlung: LED max. 9W/800lm/2.700K **G** Art. Nr. 8-309
- bulb recommendation: LED max. 9W/800Lm/2.700K **G** Item No. 8-309

G9 Fassung	Art.Nr. item no.	Ausführung design
Quadro Short	4-06620	satinieretes Glas, frosted glass

- G9 max. 33W, optional LED Retrofit
- G9 max. 33W, LED Retrofit optional
- Leuchtmittlempfehlung: LED max. 3W/300lm/2.700K/dimmbar **G** Art. Nr. 8-205
- bulb recommendation: LED max. 3W/300Lm/2.700K/dimmable **G** Item No. 8-205

GU10 Fassung	Art.Nr. item no.	Ausführung design
Quadro Short Spot	7-06629	satinieretes Glas, frosted glass

- GU10 max. 35W, optional LED Retrofit
- GU10 max. 35W, LED Retrofit optional
- Leuchtmittlempfehlung: LED max. 4W/230lm/2.700K **G** Art. Nr. 8-211
- bulb recommendation: LED max. 4W/230Lm/2.700K **G** Item No. 8-211

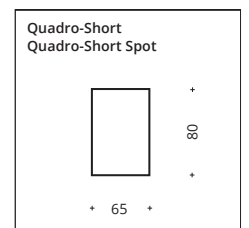
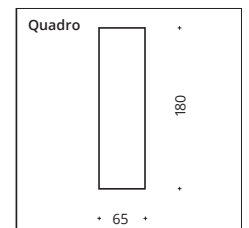





Quadro Box

Deckenleuchten für einen idealen Einsatz in Fluren und Bädern. Gefertigt aus Mattglas bietet sie ein weiches Rundum-Licht. Erhältlich mit verschiedenen Fassungen. Aufbausockel wahlweise in chrom oder nickelmatt.

Ceiling lights for ideal use in hallways and bathrooms. Made of frosted glass, it offers a soft all-round light. Available in different versions. Mounting base alternatively in chrome or nickel matt design.



Quadro Box Short Spot



Quadro Box & Quadro Box Short

INDOOR

E27 Fassung	Art.Nr. item no.	Ausführung design
● Quadro Box 80W, ~1.800lm	4-04621 4-04622	nickel matt chrome
<ul style="list-style-type: none"> E27 max. 42W, optional LED Retrofit E27 max. 42W, LED Retrofit optional Leuchtmittlempfehlung: LED max. 9W/800lm/2.700K G Art. Nr. 8-309 bulb recommendation: LED max. 9W/800Lm/2.700K G Item No. 8-309 		

G9 Fassung	Art.Nr. item no.	Ausführung design
● Quadro Box Short	4-05621 4-05622	nickel matt chrome
<ul style="list-style-type: none"> G9 max. 33W, optional LED Retrofit G9 max. 33W, LED Retrofit optional Leuchtmittlempfehlung: LED max. 3W/300lm/2.700K/dimmbar G Art. Nr. 8-205 bulb recommendation: LED max. 3W/300Lm/2.700K/dimmable G Item No. 8-205 		

GU10 Fassung	Art.Nr. item no.	Ausführung design
● Quadro Box Short Spot	4-05628 4-05629	nickel matt chrome
<ul style="list-style-type: none"> GU10 max. 35W, optional LED Retrofit GU10 max. 35W, LED Retrofit optional Leuchtmittlempfehlung: LED max. 4W/230lm/2.700K G Art. Nr. 8-211 bulb recommendation: LED max. 4W/230Lm/2.700K G Item No. 8-211 		

LED	Art.Nr. item no.	Ausführung design
G 4W, ~390lm ~2.800k		
● Quadro Box LED	4-04621-LED 4-04622-LED	nickel matt chrome
● Quadro Box Short LED	4-05621-LED 4-05622-LED	nickel matt chrome

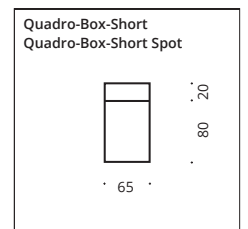
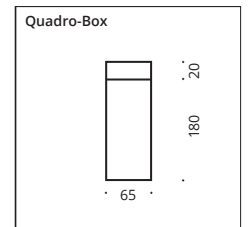





Puk Mini Inside

Deckeneinbauleuchte als ein- oder zweiflammige Leuchte lieferbar. Kopf dreh- und schwenkbar. Durch Herausziehen des Leuchtenkopfes voller Lichtaustritt bei maximaler Ausschwenkung.

Recessed ceiling luminaire available as single- or double-lamp version. Head can be rotated and swivelled. by pulling out the luminaire head, full light emission at maximum swivel.

INDOOR

Puk Mini Inside - ☉

Puk Inside LED 8W, ~600lm, ~2.700k	Puk Inside G9 Fassung	∅ in mm	Gehäuse body
7-71001	7-71001-H	158	chrome matt
7-71002	7-71002-H	158	chrome
7-71003	7-71003-H	158	nickel matt
7-71002-22	7-71002-H-22	158	white matt/chr.
7-71002-02	7-71002-H-02	158	black matt/chr.
7-71002-23	7-71002-H-23	158	anthracite matt/chr.

▶ Ohne Zubehör. Bestell-Artikelnummern für Linse, Glas, Farbfilter und die Konfigurationsempfehlung (2) auf der Einklappseite!

▶ Without accessories: Order item-no. for lens, glass, color filter and the recommended Configuration (2) are on the fold-in page!

G9 max. 33W, optional LED Retrofit
G9 max. 33W, LED Retrofit optional

Leuchtmittlempfehlung: LED max. 3W/300lm/2.700K/dimmbar Art. Nr. 8-205
bulb recommendation: LED max. 3W/300Lm/2.700K/dimmable Item No. 8-205

Puk Mini Inside - ☉

Puk Inside LED 8W, ~600lm, ~2.700k	Puk Inside G9 Fassung	L x B in mm	Gehäuse body
7-72001	7-72001-H	158 x 158	chrome matt
7-72002	7-72002-H	158 x 158	chrome
7-72003	7-72003-H	158 x 158	nickel matt
7-72002-22	7-72002-H-22	158 x 158	white matt/chr.
7-72002-02	7-72002-H-02	158 x 158	black matt/chr.
7-72002-23	7-72002-H-23	158 x 158	anthracite matt/chr.

▶ Ohne Zubehör. Bestell-Artikelnummern für Linse, Glas, Farbfilter und die Konfigurationsempfehlung (2) auf der Einklappseite!

▶ Without accessories: Order item-no. for lens, glass, color filter and the recommended Configuration (2) are on the fold-in page!

G9 max. 33W, optional LED Retrofit
G9 max. 33W, LED Retrofit optional

Leuchtmittlempfehlung: LED max. 3W/300lm/2.700K/dimmbar Art. Nr. 8-205
bulb recommendation: LED max. 3W/300Lm/2.700K/dimmable Item No. 8-205

Puk Mini Inside - ☉☉

Puk Inside Twin LED 2 x 8W, ~1.200lm, ~2.700k	Puk Inside G9 Fassung	L x B in mm	Gehäuse body
7-73001	7-73001-H	283 x 158	chrome matt
7-73002	7-73002-H	283 x 158	chrome
7-73003	7-73003-H	283 x 158	nickel matt
7-73002-22	7-73002-H-22	283 x 158	white matt/chr.
7-73002-02	7-73002-H-02	283 x 158	black matt/chr.
7-73002-23	7-73002-H-23	283 x 158	anthracite matt/chr.

▶ Ohne Zubehör. Bestell-Artikelnummern für Linse, Glas, Farbfilter und die Konfigurationsempfehlung (2) auf der Einklappseite!

▶ Without accessories: Order item-no. for lens, glass, color filter and the recommended Configuration (2) are on the fold-in page!

G9 max. 33W, optional LED Retrofit
G9 max. 33W, LED Retrofit optional

Leuchtmittlempfehlung: LED max. 3W/300lm/2.700K/dimmbar Art. Nr. 8-205
bulb recommendation: LED max. 3W/300Lm/2.700K/dimmable Item No. 8-205

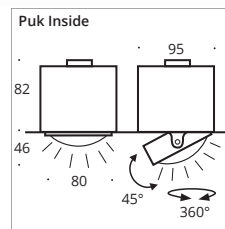
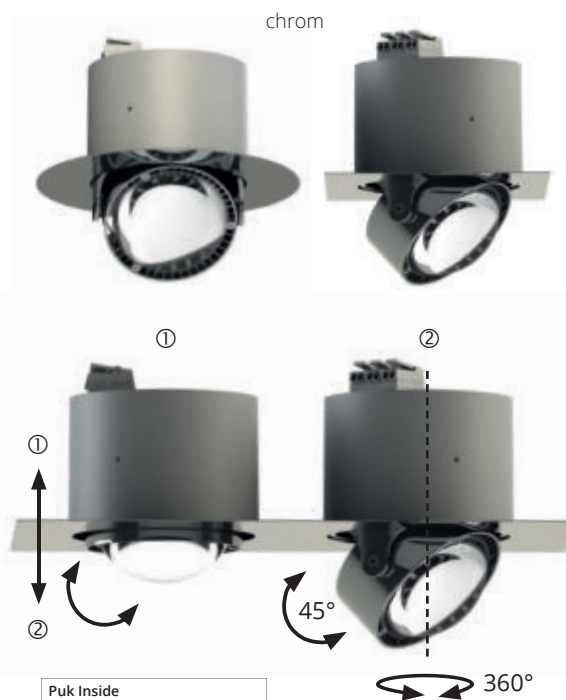
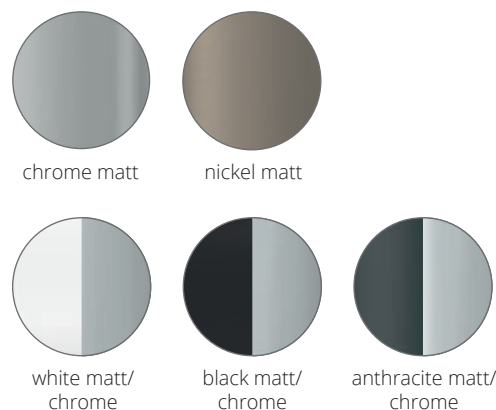

□ Chrom Teile/
chrome parts
■ Gepulverte Teile/
powder-coating

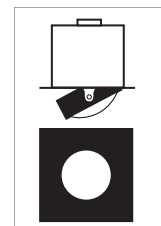
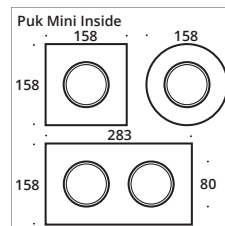

CE R LED C IP20 C (S.S 6-7/s.p. 6-7)





Puk Maxx Inside

Deckeneinbauleuchte als ein- oder zweiflammige Leuchte lieferbar. Kopf dreh- und schwenkbar. Durch Herausziehen des Leuchtenkopfes voller Lichtaustritt bei maximaler Ausschwenkung.

Recessed ceiling luminaire available as single- or double-lamp version. Head can be rotated and swivelled. by pulling out the luminaire head, full light emission at maximum swivel.

INDOOR

Puk Maxx Inside – ☉

Puk Maxx Inside LED G 12W, ~900lm, ~2.700k	Puk Maxx Inside G9 Fassung	∅ ∅ in mm	Gehäuse body
7-71301	7-71301-H	200	chrome matt
7-71302	7-71302-H	200	chrome
7-71303	7-71303-H	200	nickel matt
7-71302-22	7-71302-H-22	200	white matt/chr.
7-71302-02	7-71302-H-02	200	black matt/chr.
7-71302-23	7-71302-H-23	200	anthracite matt/chr.

- ▶ Ohne Zubehör. Bestell-Artikelnummern für Linse, Glas, Farbfilter und die Konfigurationsempfehlung (2) auf der Einklappseite!
- ▶ Without accessories: Order item-no. for lens, glass, color filter and the recommended Configuration (2) are on the fold-in page!



G9 max. 33W, optional LED Retrofit
G9 max. 33W, LED Retrofit optional

Leuchtmittlempfehlung: LED max. 3W/300lm/2.700K/dimmbar G Art. Nr. 8-205
bulb recommendation: LED max. 3W/300Lm/2.700K/dimmable G Item No. 8-205

Puk Maxx Inside – □

Puk Maxx Inside LED G 12W, ~900lm, ~2.700k	Puk Maxx Inside G9 Fassung	L x B L x B in mm	Gehäuse body
7-72301	7-72301-H	200 x 200	chrome matt
7-72302	7-72302-H	200 x 200	chrome
7-72303	7-72303-H	200 x 200	nickel matt
7-72302-22	7-72302-H-22	200 x 200	white matt/chr.
7-72302-02	7-72302-H-02	200 x 200	black matt/chr.
7-72302-23	7-72302-H-23	200 x 200	anthracite matt/chr.

- ▶ Ohne Zubehör. Bestell-Artikelnummern für Linse, Glas, Farbfilter und die Konfigurationsempfehlung (2) auf der Einklappseite!
- ▶ Without accessories: Order item-no. for lens, glass, color filter and the recommended Configuration (2) are on the fold-in page!



G9 max. 33W, optional LED Retrofit
G9 max. 33W, LED Retrofit optional

Leuchtmittlempfehlung: LED max. 3W/300lm/2.700K/dimmbar G Art. Nr. 8-205
bulb recommendation: LED max. 3W/300Lm/2.700K/dimmable G Item No. 8-205

Puk Maxx Inside – ○○

Puk Maxx Inside LED G 2 x 12W, ~1.800lm, ~2.700k	Puk Maxx Inside G9 Fassung	L x B L x B in mm	Gehäuse body
7-73301	7-73301-H	368 x 200	chrome matt
7-73302	7-73302-H	368 x 200	chrome
7-73303	7-73303-H	368 x 200	nickel matt
7-73302-22	7-73302-H-22	368 x 200	white matt/chr.
7-73302-02	7-73302-H-02	368 x 200	black matt/chr.
7-73302-23	7-73302-H-23	368 x 200	anthracite matt/chr.

- ▶ Ohne Zubehör. Bestell-Artikelnummern für Linse, Glas, Farbfilter und die Konfigurationsempfehlung (2) auf der Einklappseite!
- ▶ Without accessories: Order item-no. for lens, glass, color filter and the recommended Configuration (2) are on the fold-in page!



G9 max. 33W, optional LED Retrofit
G9 max. 33W, LED Retrofit optional

Leuchtmittlempfehlung: LED max. 3W/300lm/2.700K/dimmbar G Art. Nr. 8-205
bulb recommendation: LED max. 3W/300Lm/2.700K/dimmable G Item No. 8-205

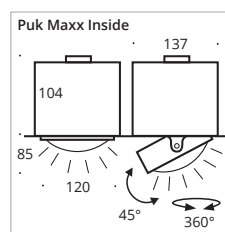
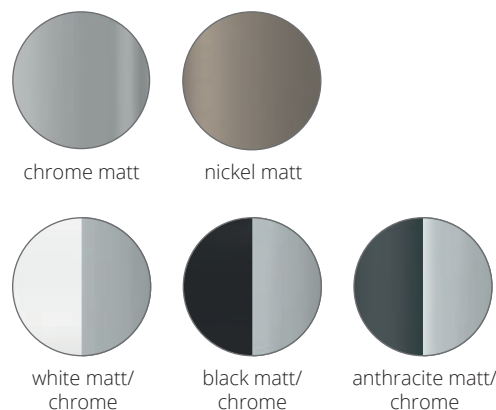

□ Chrom Teile/
chrome parts
■ Gepulverte Teile/
powder-coating

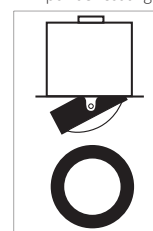
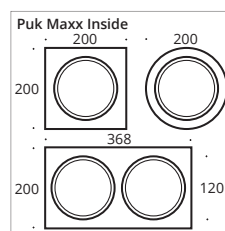

C (s.S 6-7/s.p. 6-7)



WANDLEUCHTEN

WALL LAMPS



Puk Mini Wall 115
Puk Maxx Wall 117



Puk Mini Wall »+« 119
Puk Maxx Wall »+« 121
Puk Meg Maxx Wall »+« 123



Puk Mini Hotel 125
Puk Maxx Hotel 127



Puk Mini Side Single 129
Puk Maxx Side Single 131



Puk Mini Side Twin 133
Puk Maxx Side Twin 135



Puk Mini Wing Single 137
Puk Maxx Wing Single 139



Puk Mini Wing Twin 141
Puk Maxx Wing Twin 143



Puk Maxx Next 145
Puk Meg Maxx Next 147



Puk Mini Flexlight Wall 149



Puk Mini Choice Wall 151



Puk Mini Choice Wall »+« 153



Focus 100 155
Focus 150 157



Allround Wall 161



Only Choice Wall 163



Only Choice Wall »+« 165



Lichtstange 167



Two Socket 169



Hotel Duo 171



Flexlight Wall 173



Glass- & Spotlight Wall 175





Puk Mini Wall \varnothing 80

Wandleuchte, Hochvolt Halogen, LED Retrofit oder LED Power, dimmbar.
Wall lamp, high voltage halogen, LED Retrofit or LED power, dimmable.

INDOOR



chrome

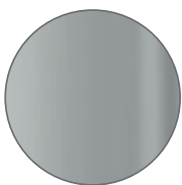

chrome matt



nickel matt

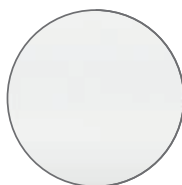

white matt

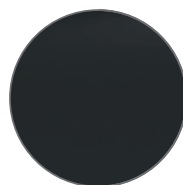

black matt

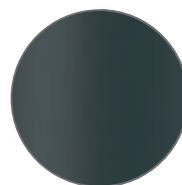

anthracite matt

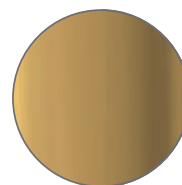

24c gold

Puk Mini Wall LED G 2 x 8W ~1.200lm ~2.700k	Puk Mini Wall LED G 2 x 4W ~600lm ~2.700k	Puk Mini Wall G9 Fassung	Wandab- stand wall spacing in mm	Gehäuse body
2-0811-LED	2-0811-4LED	2-0811	100	chrom matt
2-0812-LED	2-0812-4LED	2-0812	100	chrom
2-0813-LED	2-0813-4LED	2-0813	100	nickel matt
2-0812-LED-WE	2-0812-4LED-WE	2-0812-WE	100	weiß matt
2-0812-LED-BE	2-0812-4LED-BE	2-0812-BE	100	schwarz matt
2-0812-LED-23	2-0812-4LED-23	2-0812-23	100	anthracite matt
2-0816-LED	2-0816-4LED	2-0816	100	24 c. gold pl.

- ▶ Ohne Zubehör. Bestell-Artikelnummern für Linse, Glas, Farbfilter und die Konfigurationsempfehlung auf der Einklapppage!
- ▶ Without accessories: Order item-no. for lens, glass, color filter and the recommended Configuration are on the fold-in page!



Leuchtmittelangabe: LED Retrofit **G inkl.** ~3Watt ~300lm ~2.700K | G9 max. 33W ECO
lamp information: LED Retrofit **G incl.** ~3Watt ~300lm ~2.700K | G9 max. 33W ECO

Leuchtmittelempfehlung: LED max. 3W/300lm/2.700K/dimmbar **G** Art Nr. 8-205
bulb recommendation: LED max. 3W/300Lm/2.700K/dimmable **G** Item No. 8-205

- Chrom Teile/
chrome parts
- Gepulverte Teile/
powder-coating

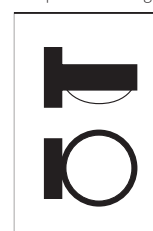
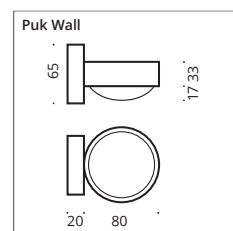





Puk Maxx Wall ø 120

Wandleuchte, LED Power, dimmbar.
Wall lamp, LED power, dimmable.

INDOOR



chrome

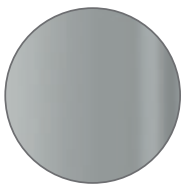

chrome matt

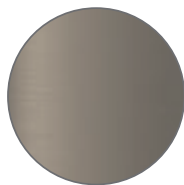

nickel matt

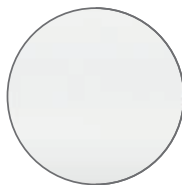

white matt

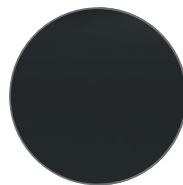

black matt

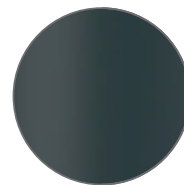

anthracite matt

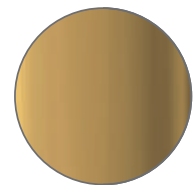

24c gold

Puk Maxx Wall LED G 2 x 12W ~1.800lm ~2.700k	Wandabstand x Höhe in mm wallspace x height in mm	Gehäuse body
2-30811	140 x 80	chrome matt
2-30812	140 x 80	chrome
2-30813	140 x 80	nickel matt
2-30812-WE	140 x 80	white matt
2-30812-BE	140 x 80	black matt
2-30812-23	140 x 80	anthracite matt
2-30816	140 x 80	24 c. gold pl.



- ▶ Ohne Zubehör. Bestell-Artikelnummern für Linse, Glas, Farbfilter und die Konfigurationsempfehlung auf der Einklappseite! 
- ▶ Without accessories: Order item-no. for lens, glass, color filter and the recommended configuration are on the fold-in page!

Leuchtmittelangabe: LED **G** inkl. | lamp information: LED **G** incl.

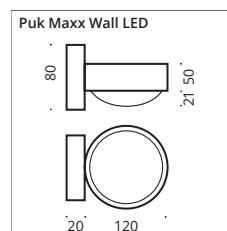

□ Chrom Teile/
chrome parts
■ Gepulverte Teile/
powder-coating





Puk Mini Wall »+« Ø 80

Wandleuchte, Hochvolt Halogen oder LED Power, dimmbar, Kopf **drehbar** mit Verstellstift.
Wall lamp, high voltage halogen or LED power, dimmable, head **rotatable** with adjusting pin.

INDOOR



chrome

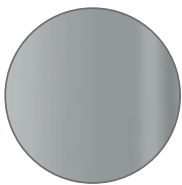

chrome matt



nickel matt

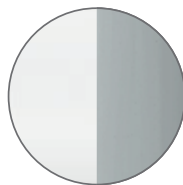

white matt/
chrome

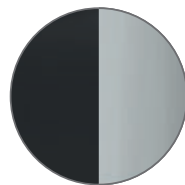

black matt/
chrome

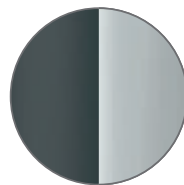

anthracite matt/
chrome

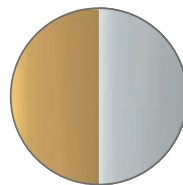

24c gold/
chrom

Puk Wall »+« LED G 2 x 8W ~1.200lm ~2.700k	Puk Wall »+« G9 Fassung	Wandabstand wall spacing in mm	Gehäuse body
2-0801-LED	2-0801	110	chrome matt
2-0802-LED	2-0802	110	chrome
2-0803-LED	2-0803	110	nickel matt
2-0802-LED-22	2-0802-22	110	white matt/chrome
2-0802-LED-02	2-0802-02	110	black matt/chrome
2-0802-LED-23	2-0802-23	110	anthracite matt/chr.
2-0806-LED	2-0806	110	24 ct gold plated/chr.

Chrom Teile/
chrome parts
 Gepulverte Teile/
powder-coating

► Ohne Zubehör. Bestell-Artikelnummern für Linse, Glas, Farbfilter und die Konfigurationsempfehlung auf der Einklappseite!

► Without accessories: Order item-no. for lens, glass, color filter and the recommended Configuration are on the fold-in page!

Leuchtmittelangabe: LED Retrofit **G inkl.** | G9 max. 33W ECO
lamp information: LED Retrofit **G incl.** | G9 max. 33W ECO

Leuchtmittelempfehlung: LED max. 3W/300lm/2.700K/dimmbar **G** Art Nr. 8-205
bulb recommendation: LED max. 3W/300Lm/2.700K/dimmable **G** Item No. 8-205

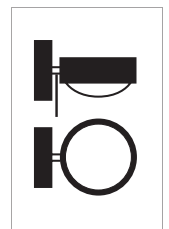
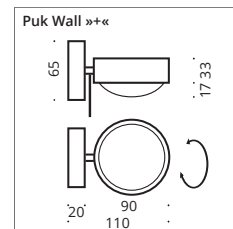

ABC (s.S 6-7/s.p. 6-7)





Puk Maxx Wall »+« Ø 120

Wandleuchte, Hochvolt Halogen oder LED Power, Kopf **drehbar** mit Verstellstift, dimmbar.
Wall lamp, high voltage halogen or LED power, head **rotatable** with adjusting pin, dimmable.

INDOOR



chrome

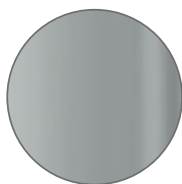

chrome matt

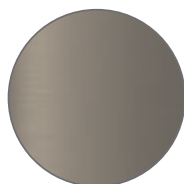

nickel matt

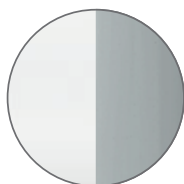

white matt/
chrome

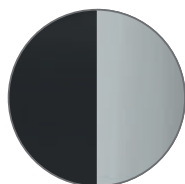

black matt/
chrome

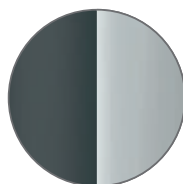

anthracite matt/
chrome

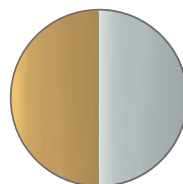

24c gold/
chrom

Puk Maxx Wall »+« LED G 2 x 12W ~1.800lm ~2.700k	Puk Maxx Wall »+« G9 Fassung	Wandabstand x Höhe wallspace x height in mm	Gehäuse body
2-30801	2-30801-H	150 x 80	chrome matt
2-30802	2-30802-H	150 x 80	chrome
2-30803	2-30803-H	150 x 80	nickel matt
2-30802-22	2-30802-H-22	150 x 80	white matt/chrome
2-30802-02	2-30802-H-02	150 x 80	black matt/chrome
2-30802-23	2-30802-H-23	150 x 80	anthracite matt/chrome
2-30806	2-30806-H	150 x 80	24 ct gold plated/chr.

▶ Ohne Zubehör. Bestell-Artikelnummern für Linse, Glas, Farbfilter und die Konfigurationsempfehlung auf der Einklappseite!



▶ Without accessories: Order item-no. for lens, glass, color filter and the recommended Configuration are on the fold-in page!

💡 Leuchtmittelangabe: LED **G** inkl. | G9 max. 33W ECO, optional LED Retrofit
bulb information: LED **G** incl. | G9 max. 33W ECO, LED Retrofit optional

💡 Leuchtmittelempfehlung: LED max. 3W/300lm/2.700K/dimmbar **G** Art Nr. 8-205
bulb recommendation: LED max. 3W/300Lm/2.700K/dimmable **G** Item No. 8-205

Puk Maxx Wall



☐ Chrom Teile/
chrome parts

■ Gepulverte Teile/
powder-coating

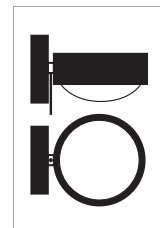
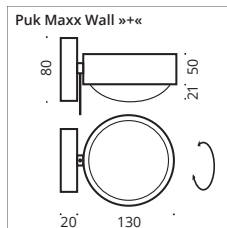





Puk Meg Maxx Wall »+« Ø 160

Wandleuchte, Hochvolt LED Power oder Hochvolt Halogen, Kopf **drehbar** mit Verstellstift, dimmbar.
Wall lamp, high LED power or high voltage halogen, head **rotatable** with adjusting pin, dimmable.

INDOOR



chrome

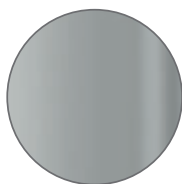

chrome matt



nickel matt

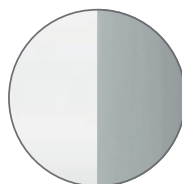

white matt/
chrome

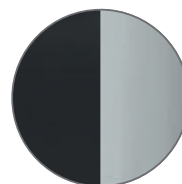

black matt/
chrome

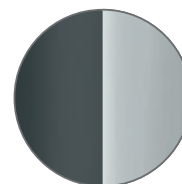

anthracite matt/
chrome

Puk Meg Maxx Wall »+« LED G 2 x 18W ~3.000lm, ~2.700k	Puk Meg Maxx Wall »+« G9 Fassung	Ø x Wand- abstand Ø x wall space in mm	Gehäuse body
2-40801	2-40801-H	160 x 185	chrome matt
2-40802	2-40802-H	160 x 185	chrome
2-40803	2-40803-H	160 x 185	nickel matt
2-40802-22	2-40802-H-22	160 x 185	white matt/chrome
2-40802-02	2-40802-H-02	160 x 185	black matt/chrome
2-40802-23	2-40802-H-23	160 x 185	anthracite matt/chr.

▶ Ohne Zubehör. Bestell-Artikelnummern für Linse, Glas, Farbfilter und die Konfigurationsempfehlung auf der Einklappseite!



▶ Without accessories: Order item-no. for lens, glass, color filter and the recommended Configuration are on the fold-in page!

Leuchtmittelangabe: LED **G** inkl. | G9 max. 33W ECO, optional LED Retrofit bulb information: LED **G** incl. | G9 max. 33W ECO, LED Retrofit optional

Leuchtmittelpfehlung: LED max. 3W/300lm/2.700K/dimmbar **G** Art Nr. 8-205
bulb recommendation: LED max. 3W/300Lm/2.700K/dimmable **G** Item No. 8-205

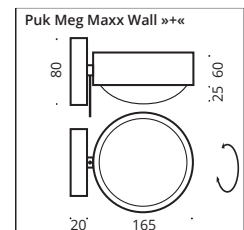

Chrom Teile/
chrome parts

Gepulverte Teile/
powder-coating

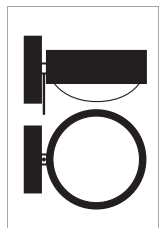





Puk Mini Hotel Ø 80

Wandleuchte, Hochvolt Halogen oder LED Power, dimmbar, Arm schwenkbar, Köpfe drehbar mit Verstellstift. Ideal für die Anwendung als Bettleseleuchte.

Wall luminaires, high voltage halogen or LED power, dimmable, arm swivelling, heads rotatable with adjustment pin. Ideal for use as bedside reading lamp.

INDOOR

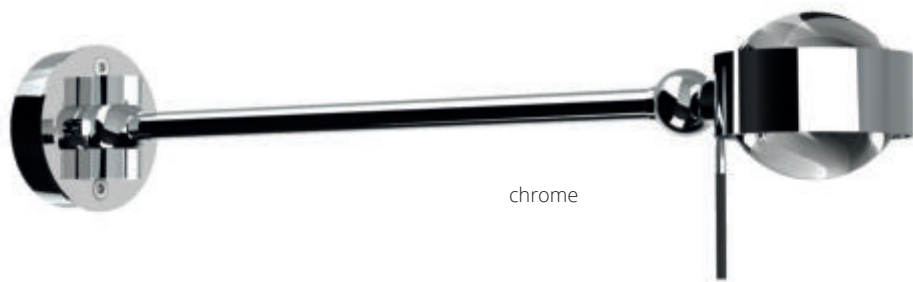

chrome

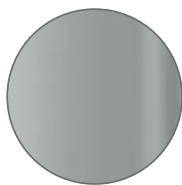

chrome matt

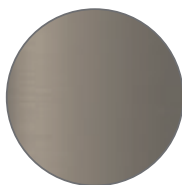

nickel matt

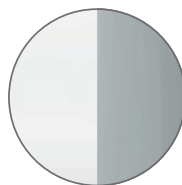

white matt/
chrome

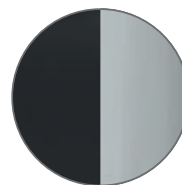

black matt/
chrome

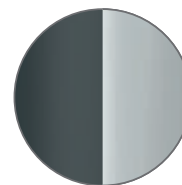

anthracite matt/
chrome

Puk Mini Hotel LED G 2 x 8W ~1.200lm ~2.700k	Puk Mini Hotel G9 Fassung	Armlänge arm length in mm	Gehäuse body
2-058201-LED	2-058201	200	chrome matt
2-058202-LED	2-058202	200	chrome
2-058203-LED	2-058203	200	nickel matt
2-058202-LED-22	2-058202-22	200	white matt/chrome
2-058202-LED-02	2-058202-02	200	black matt/chrome
2-058202-LED-23	2-058202-23	200	anthracite matt/chr.
2-058301-LED	2-058301	300	chrome matt
2-058302-LED	2-058302	300	chrome
2-058303-LED	2-058303	300	nickel matt
2-058302-LED-22	2-058302-22	300	white matt/chrome
2-058302-LED-02	2-058302-02	300	black matt/chrome
2-058302-LED-23	2-058302-23	300	anthracite matt/chr.

-K Schaltermontage optional rechts/links.
Switch mounting optional right/left.

Sonderlängen auf Anfrage. Special lengths on request.

- ▶ Ohne Zubehör. Bestell-Artikelnummern für Linse, Glas, Farbfilter und die Konfigurationsempfehlung auf der Einklappseite!
- ▶ Without accessories: Order item-no. for lens, glass, color filter and the recommended Configuration are on the fold-in page!

Leuchtmittelangabe: LED G inkl. | G9 max. 33W ECO, optional LED Retrofit
bulb information: LED G incl. | G9 max. 33W ECO, LED Retrofit optional

Leuchtmittelempfehlung: LED max. 3W/300lm/2.700K/dimmbar G Art Nr. 8-205
bulb recommendation: LED max. 3W/300Lm/2.700K/dimmable G Item No. 8-205



□ Chrom Teile/
chrome parts
■ Gepulverte Teile/
powder-coating

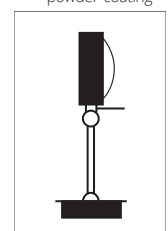
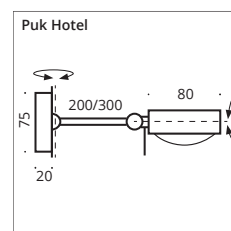





Puk Maxx Hotel ø 120

Wandleuchte, Hochvolt Halogen oder LED Power, dimmbar, Arm schwenkbar, Köpfe drehbar mit Verstellstift. Ideal für die Anwendung als Bettleseleuchte.

Wall luminaires, high voltage halogen or LED power, dimmable, arm swivelling, heads rotatable with adjustment pin. Ideal for use as bedside reading lamp.

INDOOR

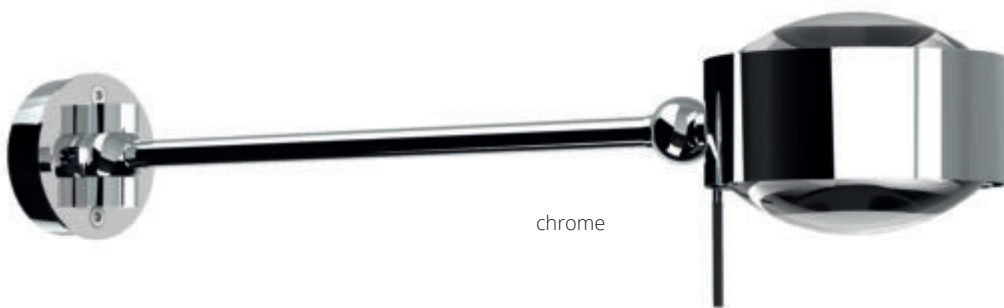

chrome

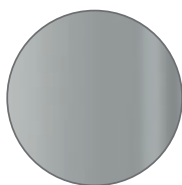

chrome matt



nickel matt

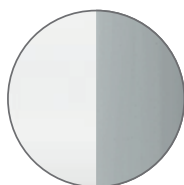

white matt/
chrome

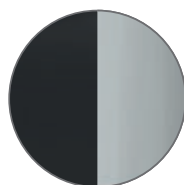

black matt/
chrome

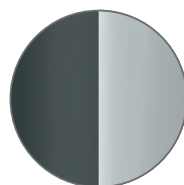

anthracite matt/
chrome

Puk Maxx Hotel LED G 2 x 12W ~1.800lm ~2.700k	Puk Maxx Hotel G9 Fassung	Armlänge arm length in mm	Gehäuse body
2-3058201-LED	2-3058201	200	chrome matt
2-3058202-LED	2-3058202	200	chrome
2-3058203-LED	2-3058203	200	nickel matt
2-3058202-LED-22	2-3058202-22	200	white matt/chrome
2-3058202-LED-02	2-3058202-02	200	black matt/chrome
2-3058202-LED-23	2-3058202-23	200	anthracite matt/chr.
2-3058301-LED	2-3058301	300	chrome matt
2-3058302-LED	2-3058302	300	chrome
2-3058303-LED	2-3058303	300	nickel matt
2-3058302-LED-22	2-3058302-22	300	white matt/chrome
2-3058302-LED-02	2-3058302-02	300	black matt/chrome
2-3058302-LED-23	2-3058302-23	300	anthracite matt/chr.

-K Schaltermontage optional rechts/links.
Switch mounting optional right/left.

Sonderlängen auf Anfrage. Special lengths on request.

- ▶ Ohne Zubehör. Bestell-Artikelnummern für Linse, Glas, Farbfilter und die Konfigurationsempfehlung auf der Einklappseite!
- ▶ Without accessories: Order item-no. for lens, glass, color filter and the recommended Configuration are on the fold-in page!

Leuchtmittelangabe: LED **G** inkl. | G9 max. 33W ECO, optional LED Retrofit
bulb information: LED **G** incl. | G9 max. 33W ECO, LED Retrofit optional

Leuchtmittlempfehlung: LED max. 3W/300lm/2.700K/dimmbar **G** Art Nr. 8-205
bulb recommendation: LED max. 3W/300Lm/2.700K/dimmable **G** Item No. 8-205



Chrom Teile/
chrome parts
 Gepulverte Teile/
powder-coating

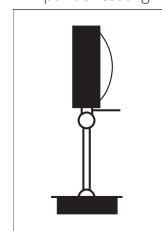
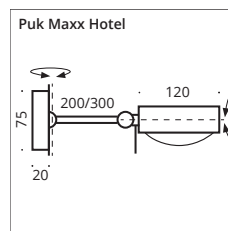



Puk Mini Side Single



Puk Mini Side Single ø 80

Wandleuchte, Hochvolt Halogen oder LED Power, dimmbar, Kopf drehbar mit Verstellstift. Mit drehbarem Arm (bis 350°).

Wall, ceiling luminaire, high voltage halogen or LED power, dimmable. Head rotatable with adjustment pin. With turnable arm (up to 350°).

INDOOR

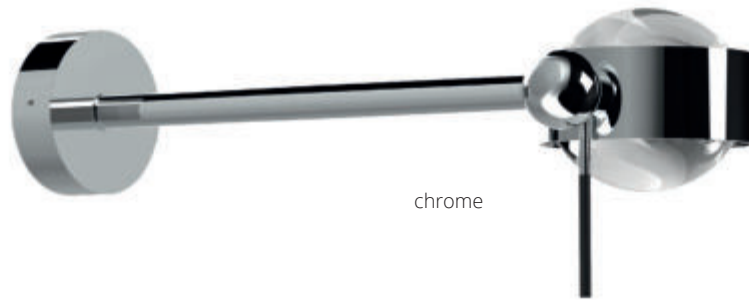

chrome

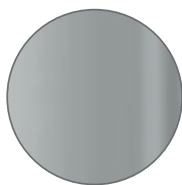

chrome matt

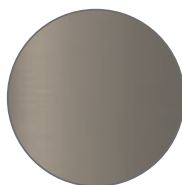

nickel matt

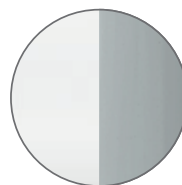

white matt/
chrome

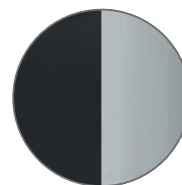

black matt/
chrome

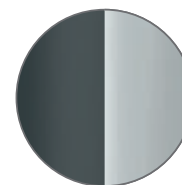

anthracite matt/
chrome

Puk Side Single LED G 2 x 8W ~1.200lm ~2.700k	Puk Side Single G9 Fassung	Armlänge arm length in mm	Gehäuse body
2-0821-LED	2-0821	100	chrome matt
2-0822-LED	2-0822	100	chrome
2-0823-LED	2-0823	100	nickel matt
2-0822-LED-22	2-0822-22	100	white matt/chr.
2-0822-LED-02	2-0822-02	100	black matt/chr.
2-0822-LED-23	2-0822-23	100	anthracite matt/chr.
2-0831-LED	2-0831	200	chrome matt
2-0832-LED	2-0832	200	chrome
2-0833-LED	2-0833	200	nickel matt
2-0832-LED-22	2-0832-22	200	white matt/chr.
2-0832-LED-02	2-0832-02	200	black matt/chr.
2-0832-LED-23	2-0832-23	200	anthracite matt/chr.
2-0861-LED	2-0861	300	chrome matt
2-08062-LED	2-08062	300	chrome
2-0863-LED	2-0863	300	nickel matt
2-08062-LED-22	2-08062-22	300	white matt/chr.
2-08062-LED-02	2-08062-02	300	black matt/chr.
2-08062-LED-23	2-08062-23	300	anthracite matt/chr.

▶ Ohne Zubehör. Bestell-Artikelnummern für Linse, Glas, Farbfilter und die Konfigurationsempfehlung auf der Einklappseite!



▶ Without accessories: Order item-no. for lens, glass, color filter and the recommended Configuration are on the fold-in page!

G9 max. 33W ECO, optional LED Retrofit
G9 max. 33W ECO, LED Retrofit optional

Leuchtmittelempfehlung: LED max. 3W/300lm/2.700K/dimmbar **G** Art Nr. 8-205
bulb recommendation: LED max. 3W/300Lm/2.700K/dimmable **G** Item No. 8-205

Chrom Teile/
chrome parts
 Gepulverte Teile/
powder-coating

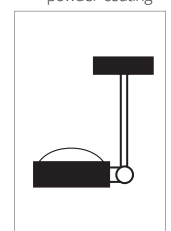
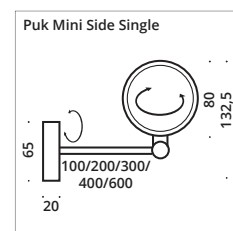





Puk Maxx Side Single ø 120

Wandleuchte mit Arm, Hochvolt Halogen oder LED Power, Kopf drehbar. Mit drehbarem Arm (bis 350°).

Wall, ceiling luminaire, high voltage halogen or LED power, dimmable. Head rotatable with adjustment pin. With turnable arm (up to 350°).

INDOOR

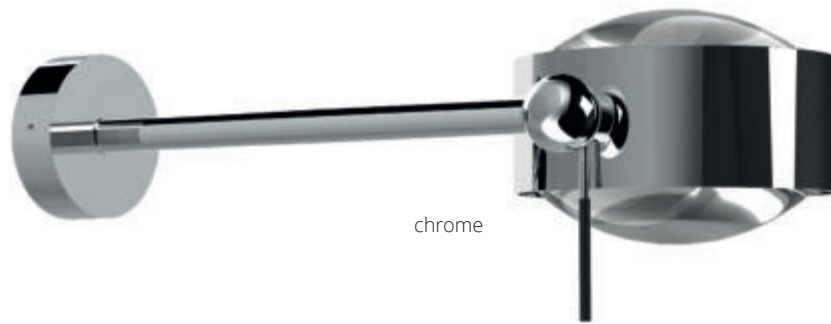

chrome

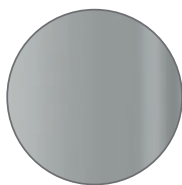

chrome matt

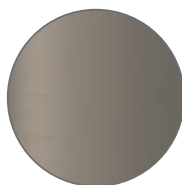

nickel matt

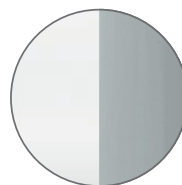

white matt/
chrome

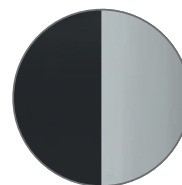

black matt/
chrome

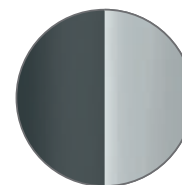

anthracite matt/
chrome

Puk Maxx Side Single LED G 2 x 12W ~1.800lm ~2.700k	Puk Maxx Side Single G9 Fassung	Armlänge arm length in mm	Gehäuse body
2-30821	2-30821-H	100	chrome matt
2-30822	2-30822-H	100	chrome
2-30823	2-30823-H	100	nickel matt
2-30822-22	2-30822-H-22	100	white matt/chr.
2-30822-02	2-30822-H-02	100	black matt/chr.
2-30822-23	2-30822-H-23	100	anthracite matt/chr.
2-30831	2-30831-H	200	chrome matt
2-30832	2-30832-H	200	chrome
2-30833	2-30833-H	200	nickel matt
2-30832-22	2-30832-H-22	200	white matt/chr.
2-30832-02	2-30832-H-02	200	black matt/chr.
2-30832-23	2-30832-H-23	200	anthracite matt/chr.
2-30861	2-30861-H	300	chrome matt
2-30862	2-30862-H	300	chrome
2-30863	2-30863-H	300	nickel matt
2-30862-22	2-30862-H-22	300	white matt/chr.
2-30862-02	2-30862-H-02	300	black matt/chr.
2-30862-23	2-30862-H-23	300	anthracite matt/chr.

▶ Ohne Zubehör. Bestell-Artikelnummern für Linse, Glas, Farbfilter und die Konfigurationsempfehlung auf der Einklappseite!



▶ Without accessories: Order item-no. for lens, glass, color filter and the recommended Configuration are on the fold-in page!

G9 max. 33W ECO, optional LED Retrofit
 G9 max. 33W ECO, LED Retrofit optional

Leuchtmittelempfehlung: LED max. 3W/300lm/2.700K/dimmbar **G** Art Nr. 8-205
 bulb recommendation: LED max. 3W/300Lm/2.700K/dimmable **G** Item No. 8-205

Chrom Teile/
chrome parts
 Gepulverte Teile/
powder-coating

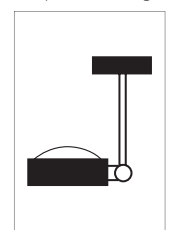
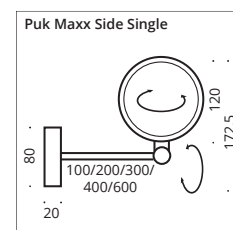



Puk Mini Side Twin



Puk Mini Side Twin \varnothing 80

Wandleuchte, Hochvolt Halogen oder LED Power, dimmbar, Köpfe drehbar mit Verstellstift. Mit drehbarem Arm (bis 350°).

Wall, ceiling luminaire, high voltage halogen or LED power, dimmable. Head rotatable with adjustment pin. Now with turable arm (350°).

INDOOR



chrome

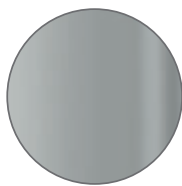

chrome matt

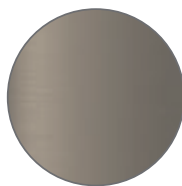

nickel matt

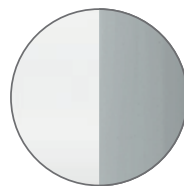

white matt/
chrome

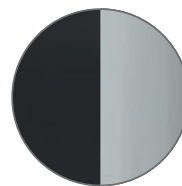

black matt/
chrome

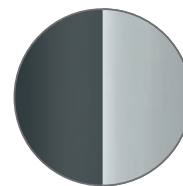

anthracite matt/
chrome

Puk Side Twin LED G 4 x 8W ~2.400lm ~2.700k	Puk Side Twin G9 Fassung	Armlänge arm length in mm	Gehäuse body
2-0841-LED	2-0841	100	chrome matt
2-0842-LED	2-0842	100	chrome
2-0843-LED	2-0843	100	nickel matt
2-0842-LED-22	2-0842-22	100	white matt/chr.
2-0842-LED-02	2-0842-02	100	black matt/chr.
2-0842-LED-23	2-0842-23	100	anthracite matt/chr.
2-0851-LED	2-0851	200	chrome matt
2-0852-LED	2-0852	200	chrome
2-0853-LED	2-0853	200	nickel matt
2-0852-LED-22	2-0852-22	200	white matt/chr.
2-0852-LED-02	2-0852-02	200	black matt/chr.
2-0852-LED-23	2-0852-23	200	anthracite matt/chr.

► Ohne Zubehör. Bestell-Artikelnummern für Linse, Glas, Farbfilter und die Konfigurationsempfehlung auf der Einklappseite!



► Without accessories: Order item-no. for lens, glass, color filter and the recommended Configuration are on the fold-in page!

Light bulb icon: G9 max. 33W ECO, optional LED Retrofit
Light bulb icon: G9 max. 33W ECO, LED Retrofit optional

Light bulb icon: Leuchtmittelempfehlung: LED max. 3W/300lm/2.700K/dimmbar Art Nr. 8-205
Light bulb icon: bulb recommendation: LED max. 3W/300Lm/2.700K/dimmable Item No. 8-205

Chrom Teile/
chrome parts
Gepulverte Teile/
powder-coating

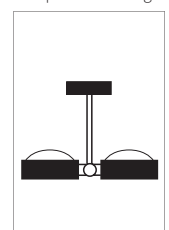
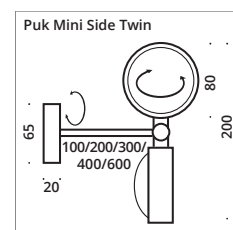





Puk Maxx Side Twin ø 120

Wandleuchte mit Arm, Hochvolt Halogen oder LED Power, Köpfe drehbar. Mit drehbarem Arm (bis 350°).

Wall, ceiling luminaire, high voltage halogen or LED power, dimmable. Head rotatable with adjustment pin. Now with turable arm (350°).

INDOOR



chrome

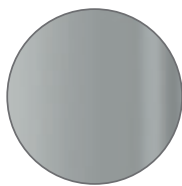

chrome matt

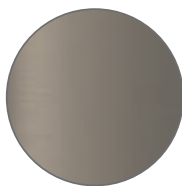

nickel matt

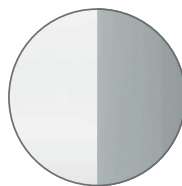

white matt/
chrome

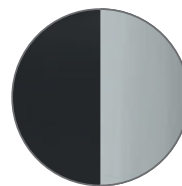

black matt/
chrome

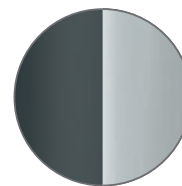

anthracite matt/
chrome

Puk Maxx Side Twin LED G 4 x 12W ~3.600lm ~2.700k	Puk Maxx Side Twin G9 Fassung	Armlänge arm length in mm	Gehäuse body
2-30841	2-30841-H	100	chrome matt
2-30842	2-30842-H	100	chrome
2-30843	2-30843-H	100	nickel matt
2-30842-22	2-30842-H-22	100	white matt/chr.
2-30842-02	2-30842-H-02	100	black matt/chr.
2-30842-23	2-30842-H-23	100	anthracite matt/chr.
2-30851	2-30851-H	200	chrome matt
2-30852	2-30852-H	200	chrome
2-30853	2-30853-H	200	nickel matt
2-30852-22	2-30852-H-22	200	white matt/chr.
2-30852-02	2-30852-H-02	200	black matt/chr.
2-30852-23	2-30852-H-23	200	anthracite matt/chr.

▶ Ohne Zubehör. Bestell-Artikelnummern für Linse, Glas, Farbfilter und die Konfigurationsempfehlung auf der Einklapppage!



▶ Without accessories: Order item-no. for lens, glass, color filter and the recommended Configuration are on the fold-in page!

G9 max. 33W ECO, optional LED Retrofit
 G9 max. 33W ECO, LED Retrofit optional

Leuchtmittel Empfehlung: LED max. 3W/300lm/2.700K/dimmbar **G** Art Nr. 8-205
 bulb recommendation: LED max. 3W/300Lm/2.700K/dimmable **G** Item No. 8-205



Chrom Teile/
chrome parts
 Gepulverte Teile/
powder-coating

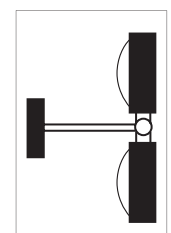
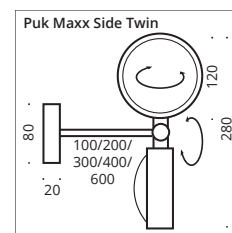



Puk Mini Wing Single



Puk Mini Wing Single \varnothing 80

Wandleuchte, Hochvolt Halogen oder LED Power, dimmbar, Kopf drehbar mit Verstellstift, Arm schwenkbar.

Wall luminaires, high voltage halogen or LED power, dimmable, arm swivelling, heads rotatable with adjustment pin.

INDOOR



chrome

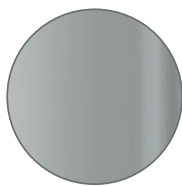

chrome matt

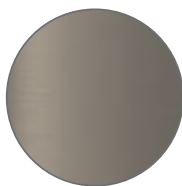

nickel matt

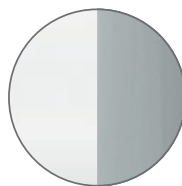

white matt/
chrome

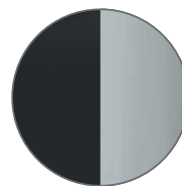

black matt/
chrome

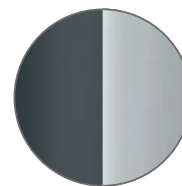

anthracite matt/
chrome

Puk Wing Single LED G 2 x 8W ~1.200lm ~2.700k	Puk Wing Single G9 Fassung L	Armlänge arm length in mm	Gehäuse body
● 2-08201-LED	2-08201	200	chrome matt
● 2-08202-LED	2-08202	200	chrome
● 2-08203-LED	2-08203	200	nickel matt
● 2-08202-LED-22	2-08202-22	200	white matt/chr.
● 2-08202-LED-02	2-08202-02	200	black matt/chr.
● 2-08202-LED-23	2-08202-23	200	anthracite matt/chr.
● 2-08301-LED	2-08301	300	chrome matt
● 2-08302-LED	2-08302	300	chrome
● 2-08303-LED	2-08303	300	nickel matt
● 2-08302-LED-22	2-08302-22	300	white matt/chr.
● 2-08302-LED-02	2-08302-02	300	black matt/chr.
● 2-08302-LED-23	2-08302-23	300	anthracite matt/chr.
● 2-08401-LED	2-08401	400	chrome matt
● 2-08402-LED	2-08402	400	chrome
● 2-08403-LED	2-08403	400	nickel matt
● 2-08402-LED-22	2-08402-22	400	white matt/chr.
● 2-08402-LED-02	2-08402-02	400	black matt/chr.
● 2-08402-LED-23	2-08402-23	400	anthracite matt/chr.

► Ohne Zubehör. Bestell-Artikelnummern für Linse, Glas, Farbfilter und die Konfigurationsempfehlung auf der Einklapppage!



► Without accessories: Order item-no. for lens, glass, color filter and the recommended Configuration are on the fold-in page!

L G9 max. 33W ECO, optional LED Retrofit
L G9 max. 33W ECO, LED Retrofit optional

L Leuchtmittelempfehlung: LED max. 3W/300lm/2.700K/dimmbar **G** Art Nr. 8-205
L bulb recommendation: LED max. 3W/300Lm/2.700K/dimmable **G** Item No. 8-205

Chrom Teile/
chrome parts
 Gepulverte Teile/
powder-coating

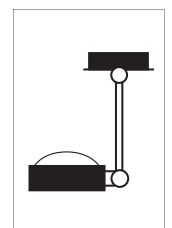
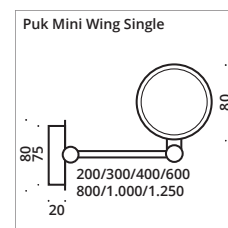



Puk Maxx Wing Single



Puk Maxx Wing Single ø 120

Wandleuchte, Hochvolt Halogen oder LED Power, dimmbar, Kopf drehbar mit Verstellstift, Arm schwenkbar.

Wall luminaires, high voltage halogen or LED power, dimmable, arm swivelling, heads rotatable with adjustment pin.

INDOOR



chrome

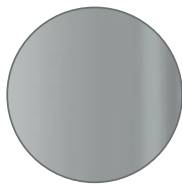

chrome matt



nickel matt

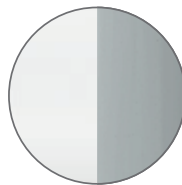

white matt/
chrome

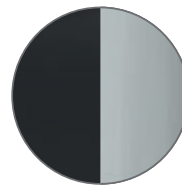

black matt/
chrome

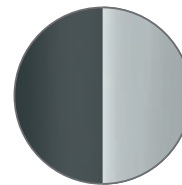

anthracite matt/
chrome

Puk Maxx Wing Single LED G 2 x 12W ~1.800lm ~2.700k	Puk Maxx Wing Single G9 Fassung	Armlänge arm length in mm	Gehäuse body
2-38201	2-38201-H	200	chrome matt
2-38202	2-38202-H	200	chrome
2-38203	2-38203-H	200	nickel matt
2-38202-22	2-38202-H-22	200	white matt/chr.
2-38202-02	2-38202-H-02	200	black matt/chr.
2-38202-23	2-38202-H-23	200	anthracite matt/chr.
2-38301	2-38301-H	300	chrome matt
2-38302	2-38302-H	300	chrome
2-38303	2-38303-H	300	nickel matt
2-38302-22	2-38302-H-22	300	white matt/chr.
2-38302-02	2-38302-H-02	300	black matt/chr.
2-38302-23	2-38302-H-23	300	anthracite matt/chr.

▶ Ohne Zubehör. Bestell-Artikelnummern für Linse, Glas, Farbfilter und die Konfigurationsempfehlung auf der Einklappseite!



▶ Without accessories: Order item-no. for lens, glass, color filter and the recommended Configuration are on the fold-in page!

💡 G9 max. 33W ECO, optional LED Retrofit
G9 max. 33W ECO, LED Retrofit optional

💡 Leuchtmittelempfehlung: LED max. 3W/300lm/2.700K/dimmbar **G** Art Nr. 8-205
bulb recommendation: LED max. 3W/300Lm/2.700K/dimmable **G** Item No. 8-205

☐ Chrom Teile/
chrome parts
■ Gepulverte Teile/
powder-coating

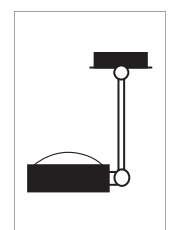
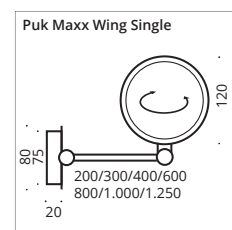



Puk Mini Wing Twin



Puk Mini Wing Twin \varnothing 80

Wandleuchte, Hochvolt Halogen oder LED Power, dimmbar, Kopf drehbar mit Verstellstift, Arm schwenkbar.

Wall luminaires, high voltage halogen or LED power, dimmable, arm swivelling, heads rotatable with adjustment pin.

INDOOR

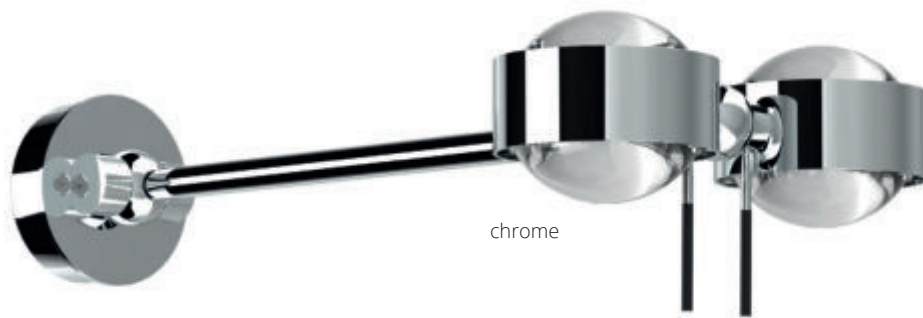

chrome

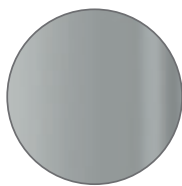

chrome matt

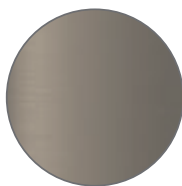

nickel matt

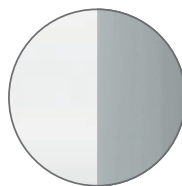

white matt/
chrome

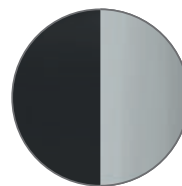

black matt/
chrome

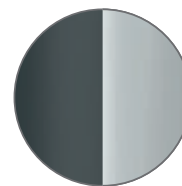

anthracite matt/
chrome

Puk Wing Twin LED G 4 x 8W ~2.400lm ~2.700k	Puk Wing Twin G9 Fassung	Armlänge arm length in mm	Gehäuse body
2-09201-LED	2-09201	200	chrome matt
2-09202-LED	2-09202	200	chrome
2-09203-LED	2-09203	200	nickel matt
2-09202-LED-22	2-09202-22	200	white matt/chr.
2-09202-LED-02	2-09202-02	200	black matt/chr.
2-09202-LED-23	2-09202-23	200	anthracite matt/chr.
2-09301-LED	2-09301	300	chrome matt
2-09302-LED	2-09302	300	chrome
2-09303-LED	2-09303	300	nickel matt
2-09302-LED-22	2-09302-22	300	white matt/chr.
2-09302-LED-02	2-09302-02	300	black matt/chr.
2-09302-LED-23	2-09302-23	300	anthracite matt/chr.
2-09401-LED	2-09401	400	chrome matt
2-09402-LED	2-09402	400	chrome
2-09403-LED	2-09403	400	nickel matt
2-09402-LED-22	2-09402-22	400	white matt/chr.
2-09402-LED-02	2-09402-02	400	black matt/chr.
2-09402-LED-23	2-09402-23	400	anthracite matt/chr.

► Ohne Zubehör. Bestell-Artikelnummern für Linse, Glas, Farbfilter und die Konfigurationsempfehlung auf der Einklappseite!



► Without accessories: Order item-no. for lens, glass, color filter and the recommended Configuration are on the fold-in page!

G9 max. 33W ECO, optional LED Retrofit
G9 max. 33W ECO, LED Retrofit optional

Leuchtmittelempfehlung: LED max. 3W/300lm/2.700K/dimmbar **G** Art Nr. 8-205
bulb recommendation: LED max. 3W/300lm/2.700K/dimmable **G** Item No. 8-205

Chrom Teile/
chrome parts
 Gepulverte Teile/
powder-coating

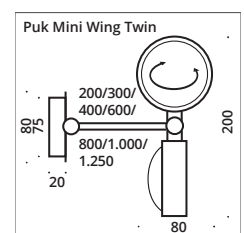
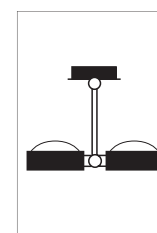





Puk Maxx Wing Twin ø 120

Wandleuchte, Hochvolt Halogen oder LED Power, dimmbar, Kopf drehbar mit Verstellstift, Arm schwenkbar.

Wall luminaires, high voltage halogen or LED power, dimmable, arm swivelling, heads rotatable with adjustment pin.

INDOOR

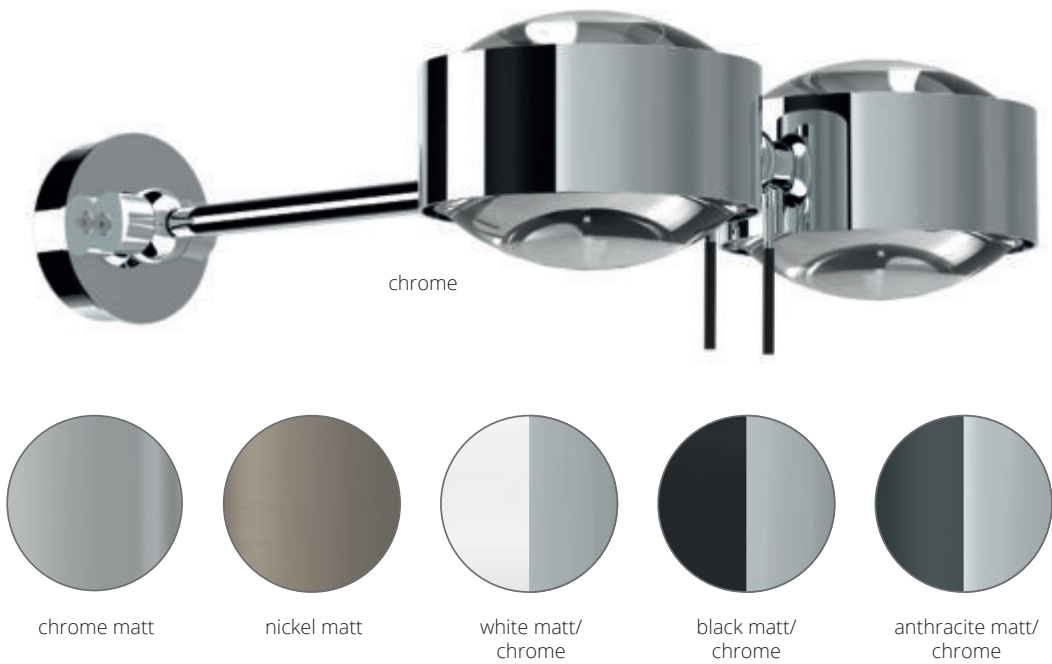

Puk Maxx Wing Twin LED G 4 x 12W ~3.600lm ~2.700k	Puk Maxx Wing Twin G9 Fassung L	Armlänge arm length in mm	Gehäuse body
● 2-39201	2-39201-H	200	chrome matt
● 2-39202	2-39202-H	200	chrome
● 2-39203	2-39203-H	200	nickel matt
● 2-39202-22	2-39202-H-22	200	white matt/chr.
● 2-39202-02	2-39202-H-02	200	black matt/chr.
● 2-39202-23	2-39202-H-23	200	anthracite matt/chr.
● 2-39301	2-39301-H	300	chrome matt
● 2-39302	2-39302-H	300	chrome
● 2-39303	2-39303-H	300	nickel matt
● 2-39302-22	2-39302-H-22	300	white matt/chr.
● 2-39302-02	2-39302-H-02	300	black matt/chr.
● 2-39302-23	2-39302-H-23	300	anthracite matt/chr.

▶ Ohne Zubehör. Bestell-Artikelnummern für Linse, Glas, Farbfilter und die Konfigurationsempfehlung auf der Einklapppage!

▶ Without accessories: Order item-no. for lens, glass, color filter and the recommended Configuration are on the fold-in page!

L G9 max. 33W ECO, optional LED Retrofit
G9 max. 33W ECO, LED Retrofit optional

L Leuchtmittelempfehlung: LED max. 3W/300lm/2.700K/dimmbar **G** Art Nr. 8-205
bulb recommendation: LED max. 3W/300Lm/2.700K/dimmable **G** Item No. 8-205

Chrom Teile/
chrome parts
 Gepulverte Teile/
powder-coating

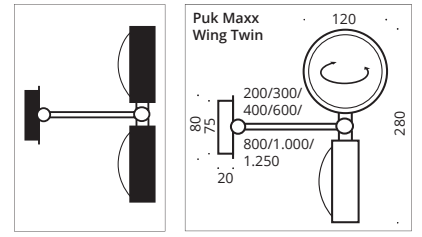

BC (s.S 6-7/s.p. 6-7)





Puk Maxx Next ø 120

Deckenleuchte, Hochvolt LED Power oder Hochvolt Halogen, dimmbar. Diese Aufbauleuchte wurde für den Wand- und Deckeneinsatz konstruiert. Mit zwei kardanis aufeinander abgestimmten Gelenken, lassen sich die Leuchtenköpfe um über 360 Grad auf zwei Achsen in jede Richtung einstellen.

Ceiling lamp, high voltage LED power or high voltage halogen, dimmable. The shaped lamp is dimmable and has been designed for ceilings and walls. With its two coordinated gimbal joints the head can be turned in two axes for more than over 360° in each direction.

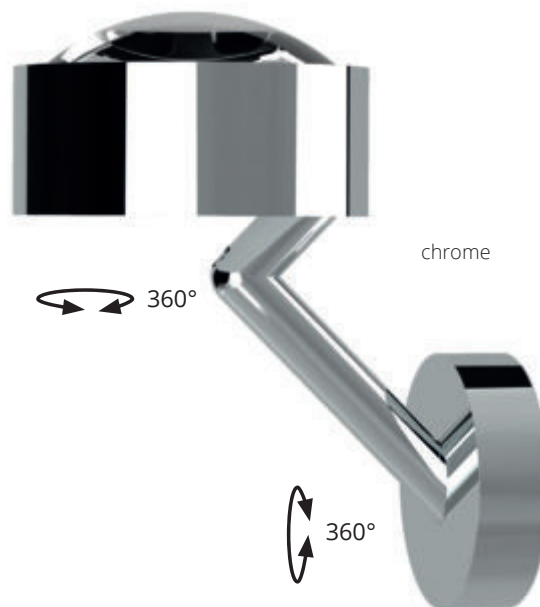
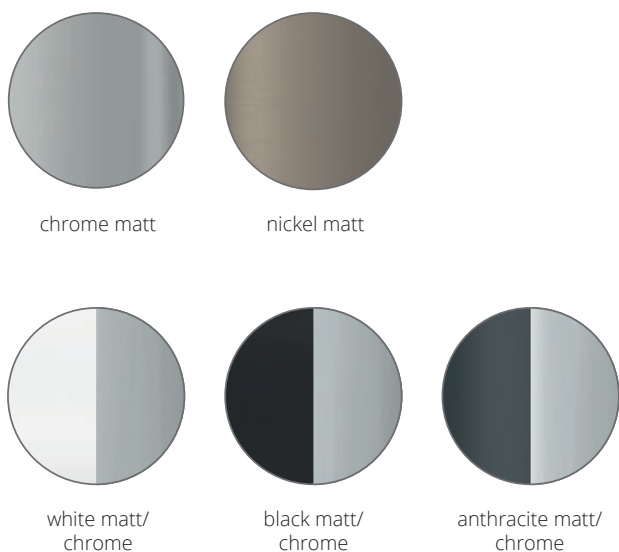

INDOOR

Puk Maxx Next LED G ~2.700k	Puk Maxx Next G9 Fassung	Kopf ø Head ø in mm	Gehäuse body
downlight 1 x 12W, ~900lm	downlight		
2-30721	2-30721-H	120	chrome matt
2-30722	2-30722-H	120	chrome
2-30723	2-30723-H	120	nickel matt
2-30722-22	2-30722-H-22	120	white matt/chr.
2-30722-02	2-30722-H-02	120	black matt/chr.
2-30722-23	2-30722-H-23	120	anthracite matt/chr.
up- & downlight 2 x 12W, ~1.800lm	up- & downlight		
2-30731	2-30731-H	120	chrome matt
2-30732	2-30732-H	120	chrome
2-30733	2-30733-H	120	nickel matt
2-30732-22	2-30732-H-22	120	white matt/chr.
2-30732-02	2-30732-H-02	120	black matt/chr.
2-30732-23	2-30732-H-23	120	anthracite matt/chr.

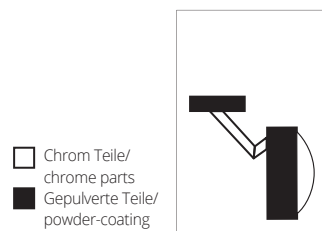

- ▶ Ohne Zubehör. Bestell-Artikelnummern für Linse, Glas, Farbfilter und die Konfigurationsempfehlung auf der Einklappseite!
- ▶ Without accessories: Order item-no. for lens, glass, color filter and the recommended Configuration are on the fold-in page!

G9 max. 33W ECO, optional LED Retrofit
 G9 max. 33W ECO, LED Retrofit optional

Leuchtmittelempfehlung: LED max. 3W/300lm/2.700K/dimmbar Art Nr. 8-205
 bulb recommendation: LED max. 3W/300Lm/2.700K/dimmable Item No. 8-205

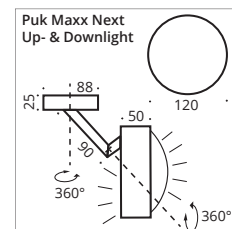
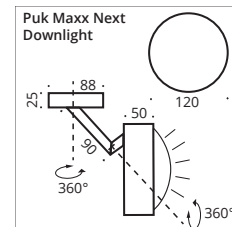





Puk Meg Maxx Next ø 160

Deckenleuchte, Hochvolt LED Power oder Hochvolt Halogen, dimmbar. Diese Aufbauleuchte wurde für den Wand- und Deckeneinsatz konstruiert, dimmbar. Mit zwei kardanis aufeinander abgestimmten Gelenken, lassen sich die LED oder Halogen Leuchtenköpfe um über 360° drehen.

Ceiling lamp, high voltage LED power or high voltage halogen, dimmable. The shaped lamp is dimmable and has been designed for ceilings and walls. With its two coordinated gimbal-joints the LED or halogen lighted head can be turned for more than over 360°.

INDOOR

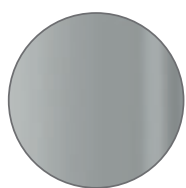

chrome matt



nickel matt

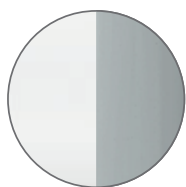

white matt/
chrome



black matt/
chrome

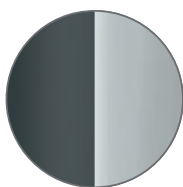

anthracite matt/
chrome

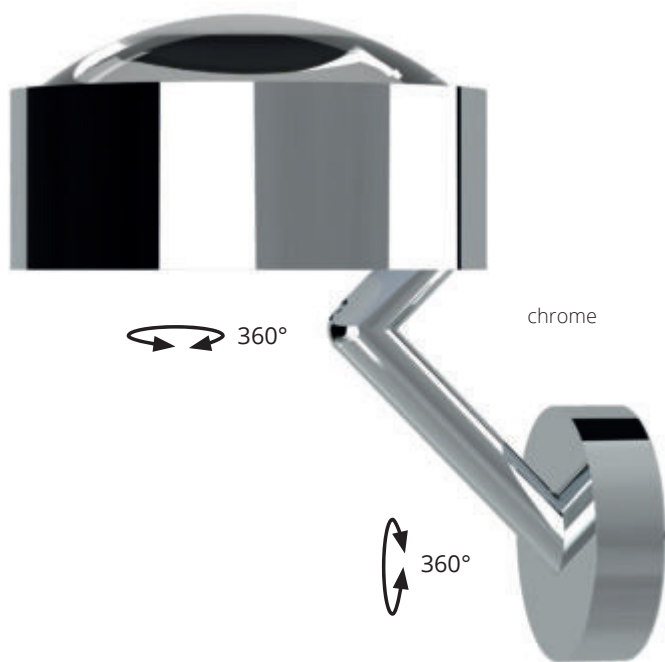

Puk Meg Maxx Next LED G ~2.700k	Puk Meg Maxx Next G9 Fassung	Kopf ø Head ø in mm	Gehäuse body
downlight 1 x 16W, ~1.200lm	downlight		
2-50721	2-50721-H	160	chrome matt
2-50722	2-50722-H	160	chrome
2-50723	2-50723-H	160	nickel matt
2-50722-22	2-50722-H-22	160	white matt/chr.
2-50722-02	2-50722-H-02	160	black matt/chr.
2-50722-23	2-50722-H-23	160	anthracite matt/chr.
up- & downlight 2 x 16W, ~2.400lm	up- & downlight		
2-50731	2-50731-H	160	chrome matt
2-50732	2-50732-H	160	chrome
2-50733	2-50733-H	160	nickel matt
2-50732-22	2-50732-H-22	160	white matt/chr.
2-50732-02	2-50732-H-02	160	black matt/chr.
2-50732-23	2-50732-H-23	160	anthracite matt/chr.

- ▶ Ohne Zubehör. Bestell-Artikelnummern für Linse, Glas, Farbfilter und die Konfigurationsempfehlung auf der Einklappseite!
- ▶ Without accessories: Order item-no. for lens, glass, color filter and the recommended Configuration are on the fold-in page!

G9 max. 33W ECO, optional LED Retrofit
 G9 max. 33W ECO, LED Retrofit optional

Leuchtmittelempfehlung: LED max. 3W/300lm/2.700K/dimmbar
 bulb recommendation: LED max. 3W/300Lm/2.700K/dimmable

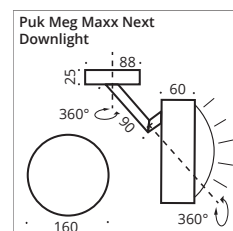
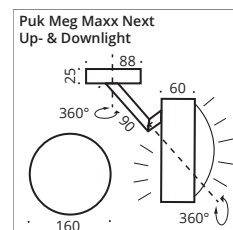
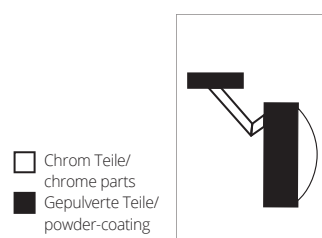



Puk Flexlight Double Wall



Puk Mini Flexlight Wall ø 80

Kombinieren Sie den Puk-Kopf mit Flexarm und Ihrer Wunschbasis, Gläser/Linsen und Farbfilter werden separat dazubestellt. Hochvolt Halogen oder LED.

Combine the Puk - head with flex arm and your desired base. Glasses/lenses and colour filters need to be ordered separately in addition. High voltage or LED.

INDOOR



Puk Flexlight Wall LED G 2 x 8W ~1.200lm ~2.700k	Puk Flexlight Wall G9 Fassung	Puk Flexlight Double Wall LED G 4 x 8W ~2.400lm ~2.700k	Puk Flexlight Double Wall G9 Fassung	Armlänge arm length in mm	Gehäuse body
● 3-4020114-LED	3-4020114	● 3-4120114-LED	3-4120114	200	chrome
● 3-4020214-LED	3-4020214	● 3-4120214-LED	3-4120214	200	nickel matt
● 3-4030114-LED	3-4030114	● 3-4130114-LED	3-4130114	300	chrome
● 3-4030214-LED	3-4030214	● 3-4130214-LED	3-4130214	300	nickel matt

▶ Ohne Zubehör. Bestell-Artikelnummern für Linse, Glas, Farbfilter und die Konfigurationsempfehlung auf der Einklapppseite!



▶ Without accessories: Order item-no. for lens, glass, color filter and the recommended Configuration are on the fold-in page!

● G9 max. 33W, optional LED Retrofit
● G9 max. 33W, LED Retrofit optional

● Leuchtmittelpfehlung: LED max. 3W/300lm/2.700K/dimmbar **G** Art Nr. 8-205
● bulb recommendation: LED max. 3W/300Lm/2.700K/dimmable **G** Item No. 8-205

CE IP20 R LED C ABC (s.S 6-7/s.p. 6-7)

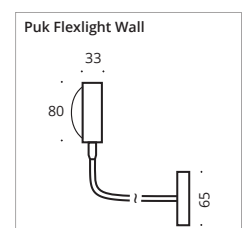



Puk Choice Mirror





Puk Mini Choice Mirror/Wall ø 80

Lichtbalken in verschiedenen Längen, bestückt mit Halogen oder LED Puk Köpfen. Zur Montage direkt an die Wand.

Light bar in various lengths for direct wall mounting. Equipped with Halogen or LED Puk Wall luminaires.



chrome

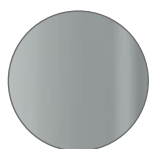

chrome matt



nickel matt

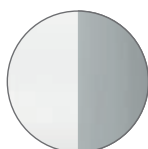

white matt/
chrome



black matt/
chrome

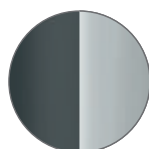

anthracite matt/
chrome

G9 Fassung

450 mm L 2 Köpfe/heads	800 mm L 3 Köpfe/heads	1.000 mm L 4 Köpfe/heads	1.200 mm L 4 Köpfe/heads	Gehäuse body
8-604021-H	8-608041-H	8-6010041-H	8-6012041-H	chrome matt
8-604022-H	8-608042-H	8-6010042-H	8-6012042-H	chrome
8-604023-H	8-608043-H	8-6010043-H	8-6012043-H	nickel matt
8-604022-H-22	8-608042-H-22	8-6010042-H-22	8-6012042-H-22	white matt/chrome
8-604022-H-02	8-608042-H-02	8-6010042-H-02	8-6012042-H-02	black matt/chrome
8-604022-H-23	8-608042-H-23	8-6010042-H-23	8-6012042-H-23	anthracite matt/chr.

- ▶ Ohne Zubehör. Bestell-Artikelnummern für Linse, Glas, Farbfilter und die Konfigurationsempfehlung auf der Einklappseite!
- ▶ Without accessories: Order item-no. for lens, glass, color filter and the recommended Configuration are on the fold-in page!



Farbig gepulverter Lichtbalken auf Anfrage. Color powdered metal rail on request.

G9 max. 33W ECO, optional LED Retrofit | G9 max. 33W ECO, LED Retrofit optional

Leuchtmittelempfehlung: LED max. 3W/300lm/2.700K/dimmbar **G** Art Nr. 8-205
bulb recommendation: LED max. 3W/300Lm/2.700K/dimmable **G** Item No. 8-205

LED

450 mm L 2 Köpfe/heads G	800 mm L 3 Köpfe/heads G	1.000 mm L 4 Köpfe/heads G	1.200 mm L 4 Köpfe/heads G	Gehäuse body
4 x 8W, ~2.400lm, ~2.700k	6 x 8W, ~3.600lm, ~2.700k	8 x 8W, ~4.800lm, ~2.700k	8 x 8W, ~4.800lm, ~2.700k	
8-604021	8-608041	8-6010041	8-6012041	chrome matt
8-604022	8-608042	8-6010042	8-6012042	chrome
8-604023	8-608043	8-6010043	8-6012043	nickel matt
8-604022-22	8-608042-22	8-6010042-22	8-6012042-22	white matt/chrome
8-604022-02	8-608042-02	8-6010042-02	8-6012042-02	black matt/chrome
8-604022-23	8-608042-23	8-6010042-23	8-6012042-23	anthracite matt/chr.

- ▶ Ohne Zubehör. Bestell-Artikelnummern für Linse, Glas, Farbfilter und die Konfigurationsempfehlung auf der Einklappseite!
- ▶ Without accessories: Order item-no. for lens, glass, color filter and the recommended Configuration are on the fold-in page!



Farbig gepulverter Lichtbalken auf Anfrage. Color powdered metal rail on request.

Sonderanfertigung:

Art-Nr. 8-600 Kürzung auf Maß

Item No. 8-600 Customized lengths



C (s.S 6-7/s.p. 6-7)

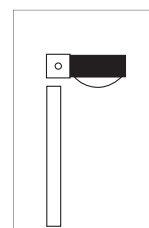
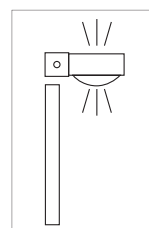
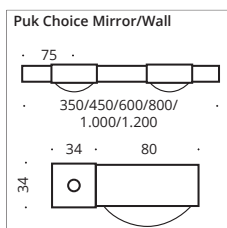

- Chrom Teile/
chrome parts
- Gepulverte Teile/
powder-coating





Puk Mini Choice Mirror/Wall »+« Ø 80

Lichtbalken in verschiedenen Längen, bestückt mit Halogen oder LED Puk Wall Köpfen. Zur Montage mit Abstandhalter-Röhrchen, um eine direktere Spiegelbeleuchtung zu ermöglichen. Einseitig mit LED-Stripes illuminiertes Metall Profil.

Light bars in various lengths, equipped with halogen or LED Puk Wall heads. For mounting with spacer tubes to allow direct mirror lighting. Metal profile illuminated on one side with LED stripes.



chrome

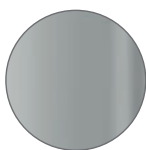

chrome matt



nickel matt



white matt/
chrome

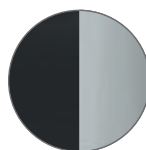

black matt/
chrome

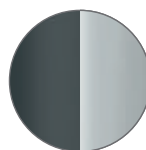

anthracite matt/
chrome

G9 Fassung

450 mm L 2 Köpfe/heads LED 9W	800 mm L 3 Köpfe/heads LED 13,5W	1.000 mm L 4 Köpfe/heads LED 22,5W	1.200 mm L 4 Köpfe/heads LED 22,5W	Gehäuse body
8-604021-H/+ 8-604022-H/+ 8-604023-H/+ 8-604022-H/+22 8-604022-H/+02 8-604022-H/+23	8-608041-H/+ 8-608042-H/+ 8-608043-H/+ 8-608042-H/+22 8-608042-H/+02 8-608042-H/+23	8-6010041-H/+ 8-6010042-H/+ 8-6010043-H/+ 8-6010042-H/+22 8-6010042-H/+02 8-6010042-H/+23	8-6012041-H/+ 8-6012042-H/+ 8-6012043-H/+ 8-6012042-H/+22 8-6012042-H/+02 8-6012042-H/+23	chrome matt chrome nickel matt white matt/chrome black matt/chrome anthracite matt/chr.

- ▶ Ohne Zubehör. Bestell-Artikelnummern für Linse, Glas, Farbfilter und die Konfigurationsempfehlung auf der Einklappseite!
- ▶ Without accessories: Order item-no. for lens, glass, color filter and the recommended Configuration are on the fold-in page!



Farbig gepulverter Lichtbalken auf Anfrage. Color powdered metal rail on request.

G9 max. 33W ECO, optional LED Retrofit | G9 max. 33W ECO, LED Retrofit optional

Leuchtmittelempfehlung: LED max. 3W/300lm/2.700K/dimmbar **G** Art Nr. 8-205
bulb recommendation: LED max. 3W/300Lm/2.700K/dimmable **G** Item No. 8-205

LED

450 mm L 2 Köpfe/heads G 4 x 8W, ~2.400lm, ~2.700k LED 9W	800 mm L 3 Köpfe/heads G 6 x 8W, ~3.600lm, ~2.700k LED 13,5W	1.000 mm L 4 Köpfe/heads G 8 x 8W, ~4.800lm, ~2.700k LED 22,5W	1.200 mm L 4 Köpfe/heads G 8 x 8W, ~4.800lm, ~2.700k LED 22,5W	Gehäuse body
8-604021/+ 8-604022/+ 8-604023/+ 8-604022/+22 8-604022/+02 8-604022/+23	8-608041/+ 8-608042/+ 8-608043/+ 8-608042/+22 8-608042/+02 8-608042/+23	8-6010041/+ 8-6010042/+ 8-6010043/+ 8-6010042/+22 8-6010042/+02 8-6010042/+23	8-6012041/+ 8-6012042/+ 8-6012043/+ 8-6012042/+22 8-6012042/+02 8-6012042/+23	chrome matt chrome nickel matt white matt/chrome black matt/chrome anthracite matt/chr.

- ▶ Ohne Zubehör. Bestell-Artikelnummern für Linse, Glas, Farbfilter und die Konfigurationsempfehlung auf der Einklappseite!
- ▶ Without accessories: Order item-no. for lens, glass, color filter and the recommended Configuration are on the fold-in page!



Farbig gepulverter Lichtbalken auf Anfrage. Color powdered metal rail on request.

Sonderanfertigung:

Art-Nr. 8-600 Kürzung auf Maß

Item No. 8-600 Customized lengths

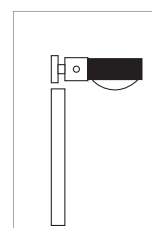
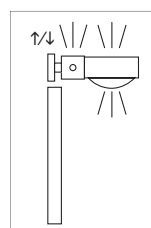
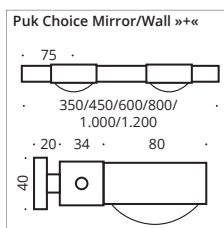

□ Chrom Teile/
chrome parts
■ Gepulverte Teile/
powder-coating





Focus 100

100 mm breite Wandleuchte in chrom oder nickelmatt, wahlweise in LED- oder Hochvolt Halogen Ausführung, alle dimmbar.

100 mm wide wall lamp in chrome or nickel matt, available in LED or high voltage halogen design, all dimmable.

INDOOR

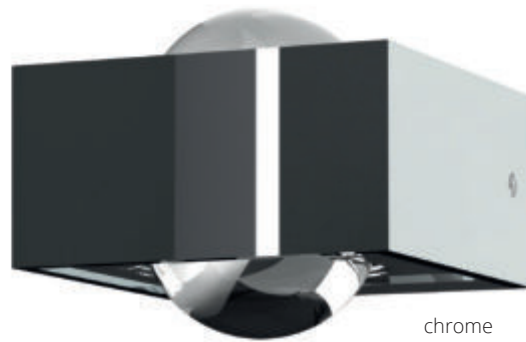

chrome

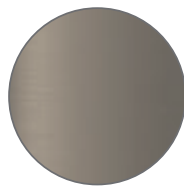

nickel matt

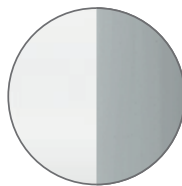

white matt/
chrome

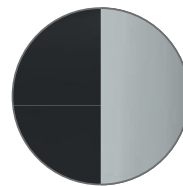

black matt/
chrome

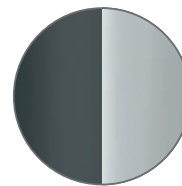

anthracite matt/
chrome

LED	G9 Fassung	Gehäuse body
2 x 8W ~1.200lm ~2.700k		
2-101001-LED	2-101001	nickel matt
2-101002-LED	2-101002	chrome
2-101002-LED-22	2-101002-22	white matt/chrome
2-101002-LED-02	2-101002-02	black matt/chrome
2-101002-LED-23	2-101002-23	anthracite matt/chrome

▶ Ohne Zubehör. Bestell-Artikelnummern für Linse, Glas und Farbfilter auf Seite 159!
▶ Without accessories: Order item-no. for lens, glass and color filter are on page 159!

G9 max. 33W ECO, optional LED Retrofit
 G9 max. 33W ECO, LED Retrofit optional

Leuchtmittelempfehlung: LED max. 3W/300lm/2.700K/dimmbar Art Nr. 8-205
 bulb recommendation: LED max. 3W/300Lm/2.700K/dimmable Item No. 8-205

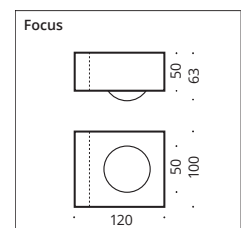





Focus 150

150 mm breite Wandleuchte in chrom oder nickelmatt, wahlweise in LED- oder Hochvolt Halogen Ausführung, alle dimmbar.

150 mm wide wall lamp in chrome or nickel matt, available in LED or high voltage halogen design, all dimmable.

INDOOR



chrome



nickel matt

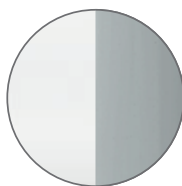

white matt/
chrome

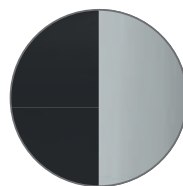

black matt/
chrome

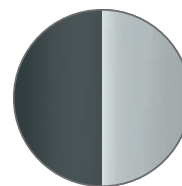

anthracite matt/
chrome

LED	G9 Fassung	Gehäuse body
G ~2.700k		
2-101501-LED 2 x 8W ~1.200lm	2-101501 1 x LS	nickel matt
2-101502-LED 2 x 8W ~1.200lm	2-101502 1 x LS	chrome
2-101502-LED-22 2 x 8W ~1.200lm	2-101502-22 1 x LS	white matt/chrome
2-101502-LED-02 2 x 8W ~1.200lm	2-101502-02 1 x LS	black matt/chrome
2-101502-LED-23 2 x 8W ~1.200lm	2-101502-23 1 x LS	anthracite matt/chrome
2-101503-LED 4 x 4W ~1.200lm	2-101503 2 x LS	nickel matt
2-101504-LED 4 x 4W ~1.200lm	2-101504 2 x LS	chrome
2-101504-LED-22 4 x 4W ~1.200lm	2-101504-22 2 x LS	white matt/chrome
2-101504-LED-02 4 x 4W ~1.200lm	2-101504-02 2 x LS	black matt/chrome
2-101504-LED-23 4 x 4W ~1.200lm	2-101504-23 2 x LS	anthracite matt/chrome
	2-101505 3 x LS	nickel matt
	2-101506 3 x LS	chrome
	2-101506-22 3 x LS	white matt/chrome
	2-101506-02 3 x LS	black matt/chrome
	2-101506-23 3 x LS	anthracite matt/chrome

▶ Ohne Zubehör. Bestell-Artikelnummern für Linse, Glas und Farbfilter auf Seite 159!
▶ Without accessories: Order item-no. for lens, glass and color filter are on page 159!

G9 max. 33W ECO, optional LED Retrofit
 G9 max. 33W ECO, LED Retrofit optional

Leuchtmittelempfehlung: LED max. 3W/300lm/2.700K/dimmbar **G** Art Nr. 8-205
 bulb recommendation: LED max. 3W/300Lm/2.700K/dimmable **G** Item No. 8-205

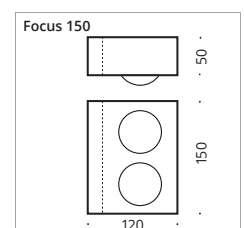





Focus Equipment

Linsen, Gläser, Farbfilter und Spiegelhalter frei zu kombinieren.

Lenses, glasses, colour filters and mirror holders can be freely combined.

INDOOR



Art. Nr. item no.	Einsatz insert	Beschreibung description
2-625	Alurefektor, aluminium baffle	Lichtstopp, empfohlen unter Glas Lightstop, recommended under glass
2-626	Linse, lens	klar, clear
2-626-s	Linse, lens	einseitig mattiert, frosted on one side
2-627	Glas, glass	beidseitig mattiert, passt nicht unter Linse frosted on both sides, doesn't fit under lens
2-628	Farbfilter, color filter	rot, red
2-629		magenta, magenta
2-630		gelb, yellow
2-633		blau, blue
2-634		grün, green
2-1201	Spiegelhalter	Klemmmontage am Spiegel, Spring mounting on mirror

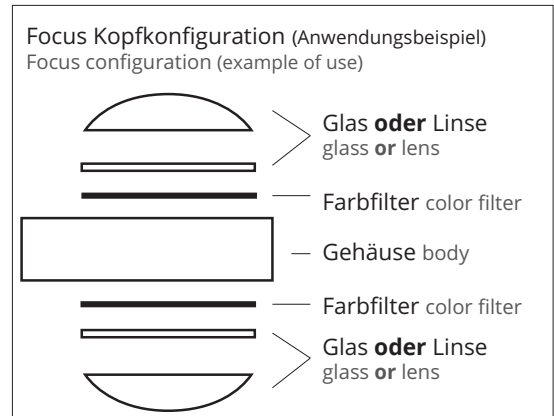

rot, red

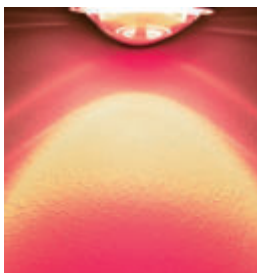

magenta, magenta

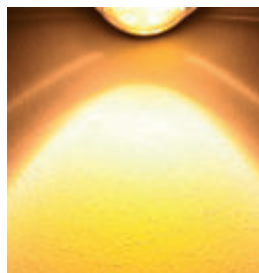

gelb, yellow



blau, blue

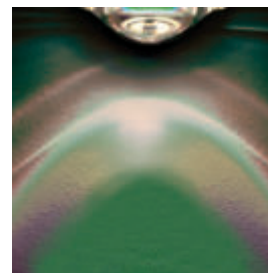

grün, green





Allround ø 120/160/240

Diese Aufbauleuchte wurde für den Wand- und Deckeneinsatz konstruiert, dimmbar. Mit zwei kardanisch aufeinander abgestimmten Gelenken, lassen sich die LED Leuchtenköpfe um über 360 Grad drehen. Mit drei Leuchtenkopfdurchmessern (ø120mm/8W/920lm, ø160mm/12W/1300lm, ø240mm/16W/1600lm, durchgängig 2700k), sind die Leuchten für viele Anwendungen im Privat- oder Objektbereich planbar.

This surface-mounted luminaire was designed for wall and ceiling use, dimmable. With two gimbal-mounted joints, the LED luminaire heads can be rotated through more than 360 degrees. With three luminaire head diameters (ø120mm/8W/920lm, ø160mm/12W/1300lm, ø240mm/16W/1600lm, 2700k throughout all models), the luminaires can be integrated for many applications in the residential and project sector.

INDOOR

Allround in Bewegung (Wandbefestigung) Allround in motion (wall mounting)



Allround in Bewegung (Deckenbefestigung) Allround in motion (ceiling mounting)



chrome

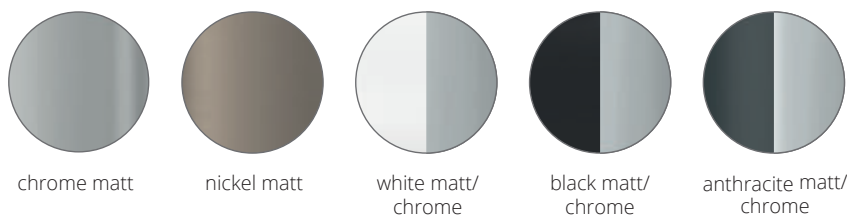

Allround 120 mm ø	Allround 160 mm ø	Allround 240 mm ø	Gehäuse body
LED: G 8 Watt, ~2.700k ~920 lm	LED: G 12 Watt, ~2.700k ~1.300 lm	LED: G 16 Watt, ~2.700k ~1.600 lm	
● 7-2201211	7-2201611	7-2202411	chrome matt
● 7-2201212	7-2201612	7-2202412	chrome
● 7-2201213	7-2201613	7-2202413	nickel matt
● 7-2201212-22	7-2201612-22	7-2202412-22	white matt/chrome
● 7-2201212-02	7-2201612-02	7-2202412-02	black matt/chrome
● 7-2201212-23	7-2201612-23	7-2202412-23	anthracite matt/chr.

- Chrom Teile/
chrome parts
- Gepulverte Teile/
powder-coating

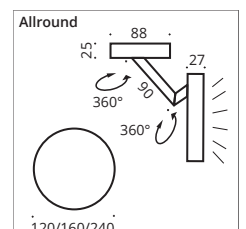
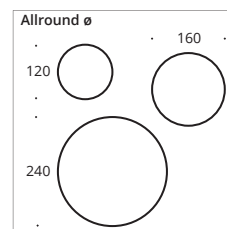
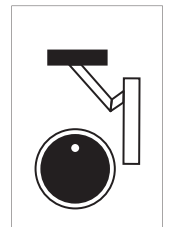





Only Choice Wall

Geradlinige LED Leuchte für die Direktmontage mit Prismen-
diffusor. Für den Objekt- und Privatbereich der Officeanwen-
dung.

Linear LED luminaire for direct mounting with prismatic dif-
fuser. For project and residential use.

INDOOR

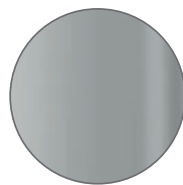

chrome matt

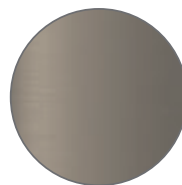

nickel matt

chrome



Only Choice Direktmontage

350 mm L	600 mm L	800 mm L	1.250 mm L	Gehäuse body
LED: G 9W, ~720lm, ~3.000k	LED: G 13,5W, ~1080lm, ~3.000k	LED: G 22,5W, ~1800lm, ~3.000k	LED: G 36W, ~2880lm, ~3.000k	
● 8-601351	8-601651	8-601951	8-6011251	chrome matt
● 8-601352	8-601652	8-601952	8-6011252	chrome
● 8-601353	8-601653	8-601953	8-6011253	nickel matt

Farbig gepulverter Lichtbalken auf Anfrage. Color powdered metal rail on request.

Bitte hinter die Art.-Nr. den Buchstaben (D-F) der gewünschten Decken- oder
Wandvariante hängen. Durch Versetzen der Endkappen ist jede Variante montierbar.
Please attach the character (D-F) to the item no. of the ceiling or wall variant you have
chosen. With turning the endpieces the lamp can be mounted in every possibility D-F.

C (s.S 6-7/s.p. 6-7)

Sonderanfertigung:

Art-Nr. 8-600 Kürzung auf Maß

Item No. 8-600 Customized lengths

Montagevarianten:

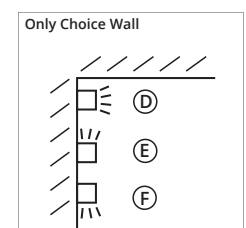
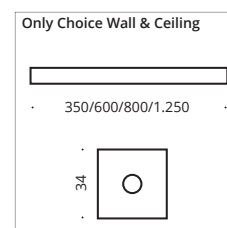





Only Choice Wall »+«

Geradlinige LED Leuchte für die Direktmontage mit Prismen-
diffusor. Für den Objekt- und Privatbereich der Officeanwen-
dung.

Linear LED luminaire for direct mounting with prismatic dif-
fuser. For project and residential use.

INDOOR

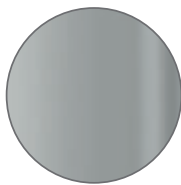
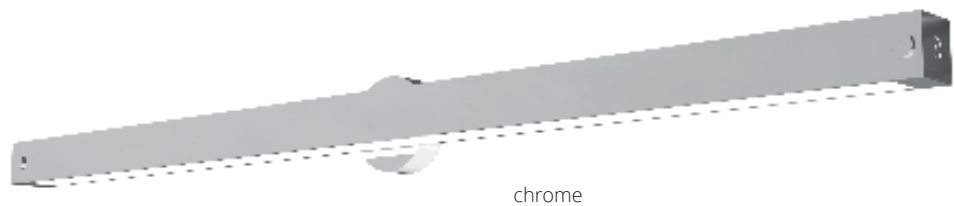

chrome matt

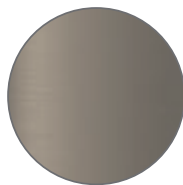

nickel matt

Only Choice »+« Rohr montierbar auf Abstand

350 mm L	600 mm L	800 mm L	1.250 mm L	Gehäuse body
LED: G 9W, ~720lm, ~3.000k	LED: G 13,5W, ~1080lm, ~3.000k	LED: G 22,5W, ~1800lm, ~3.000k	LED: G 36W, ~2880lm, ~3.000k	
8-602351	8-602651	8-602951	8-6021251	chr. matt
8-602352	8-602652	8-602952	8-6021252	chrome
8-602353	8-602653	8-602953	8-6021253	nick. matt

Farbig gepulverter Lichtbalkenauf Anfrage. Color powdered metal rail on request.

Bitte hinter die Art.-Nr. den Buchstaben (K-M) der gewünschten Wandvariante hängen.
Durch Versetzen der Endkappen ist jede Variante montierbar.

Please attach the character (K-M) to the item no. of the wall variant you have chosen.
With turning the endpieces the lamp can be mounted in every possibility K-M.



Sonderanfertigung:

Art-Nr. 8-600 Kürzung auf Maß

Item No. 8-600 Customized lengths

Montagevarianten:

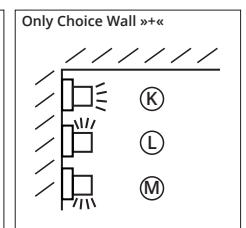
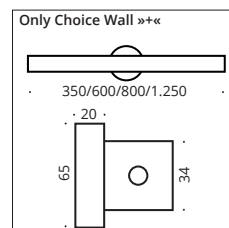



Lichtstange



Lichtstange

Erhältlich als Wandleuchte, mit LED-Röhre 1-sockelig in opal, optional mit Kippschalter, Wandabstand 70 mm. Als Lichtstange mit Klemmbefestigung zur Montage am Spiegel, mit transparentem Kabel, Schalter und Stecker, Leuchtmittel LED (8W).

Available as wall luminaire with LED tube 1-socket in opal. Optionally with flip switch, wall distance 70 mm. As a light bar with clip fastening for mounting on the mirror, with transparent cable, switch and plug. Light source LED (8W).

INDOOR

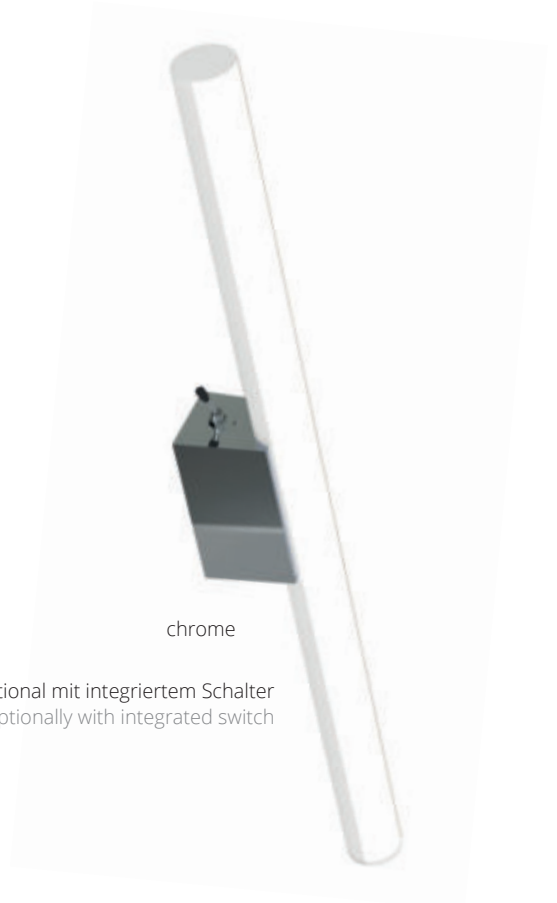
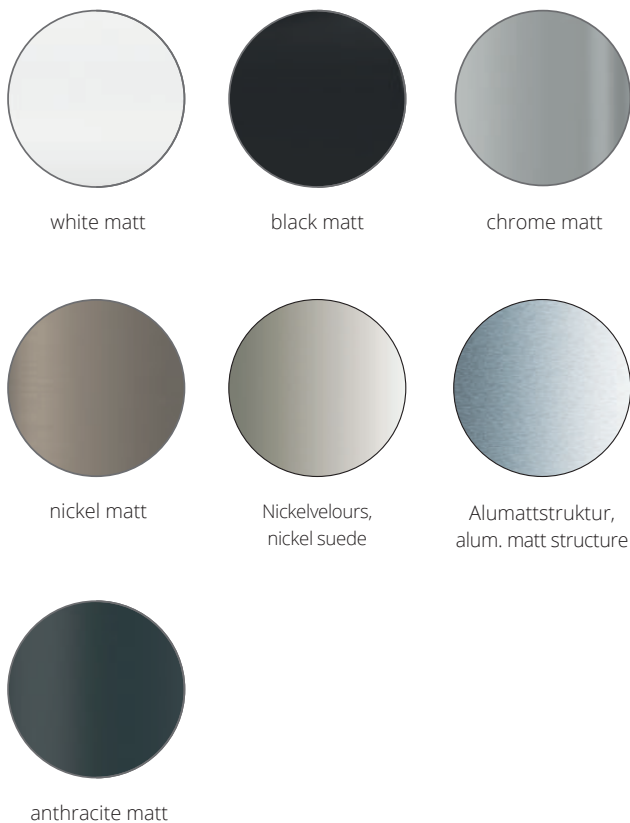

LED	LED	Ausführung design
S14D Sockel ohne Leuchtmittel without lamp	G 8W ~700lm, ~2.700k	
● 2-0302	2-0302-LED	chrome
● 2-0302-WE	2-0302-LED-WE	white matt
● 2-0302-BE	2-0302-LED-BE	black matt
● 2-0301	2-0301-LED	chrome matt
● 2-0309	2-0309-LED	nickel matt
● 2-0303	2-0303-LED	nickel suede
● 2-0304	2-0304-LED	alum. matt texture
● 2-0302-23	2-0302-LED-23	anthracite matt

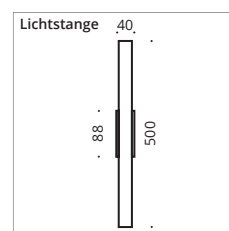

Für einen integr. Schalter hängen Sie bitte ein -K hinter die Art.-Nr.
Please attach -K behind the item-no. for an integrated switch.





Two Socket

Gerade richtig ist die extra lange Wandleuchte für den Spiegeleinsatz und zur Ausleuchtung von Bildern.

Just right is the extra long wall lamp for mirror use and for illuminating pictures.

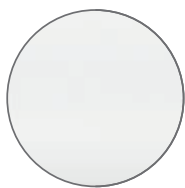

white matt

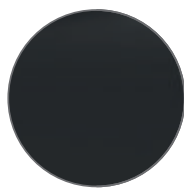

black matt

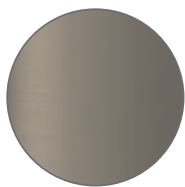

nickel matt

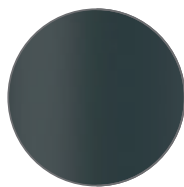

anthracite matt



Two Socket chrome



Two Socket Base chrome

INDOOR

Modell model	LED S14D Socket ohne Leuchtmittel without lamp	LED G 16W, ~1.450lm, ~3.000k	Ausführung design	Beschreibung specification
<ul style="list-style-type: none"> Two Socket 	<ul style="list-style-type: none"> 2-0402 2-0409 2-0402-22 2-0402-02 2-0402-23 	<ul style="list-style-type: none"> 2-0402-LED 2-0409-LED 2-0402-LED-22 2-0402-LED-02 2-0402-LED-23 	<ul style="list-style-type: none"> chrome nickel matt white matt black matt anthracite matt 	<ul style="list-style-type: none"> Wandleuchte, 2-sockelig, maximal 120 Watt Wall lamp, 2 bases, max.120 watts
<ul style="list-style-type: none"> Two Socket Base 	<ul style="list-style-type: none"> 2-0422 2-0429 2-0422-22 2-0422-02 2-0422-23 	<ul style="list-style-type: none"> 2-0422-LED 2-0429-LED 2-0422-LED-22 2-0422-LED-02 2-0422-LED-23 	<ul style="list-style-type: none"> chrome nickel matt white matt black matt anthracite matt 	<ul style="list-style-type: none"> Wandleuchte mit Grundplatte, 2-sockelig, max. 120 Watt Wall lamp with base plate, 2 bases, max.120 watts

Für einen integr. Schalter hängen Sie bitte ein -K hinter die Art.-Nr.
Please attach -K behind the item-no. for an integrated switch.

CE LED C IP20 Two Socket: Base: C (s.S 6-7/s.p. 6-7)

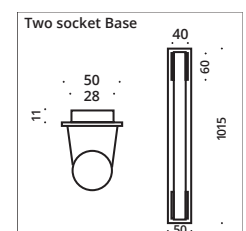





Hotel Duo

Wandleuchte mit Doppelfunktion. Der feste Arm mit farbigem Schirm bietet angenehmes, indirektes Licht. Der Spot mit Flexarm und Rio-Kopf bringt das Licht dahin, wo man es benötigt, z. B. als Leseleuchte am Bett.

Wall lamp with a dual function. The fixed arm combined with a colored shade provides indirect pleasant light. The flexible arm with a Rio Head can be adjusted wherever the light is needed. E.g. as a bedside lamp.

Artikelnr. Beispiel für abgebildete Leuchte. Example of item-no. for the lamp pictured.

24-170201 + SI-100R = 24-170201-SI-100R

Hotel Duo

Schirm E14
Spot GU10

Gehäuse
body

24-170201- + Schirm s. unten
+ shade s. below

nickel matt

Für einen integr. Schalter hängen Sie bitte ein -K hinter die Art.-Nr.
Please attach -K behind the item-no. for an integrated switch.

Leuchtmittelangabe E14

E14 max 20W; opt. LED

Leuchtmittlempfehlung

Art. Nr. 8-524

LED ~6W ~470lm ~2.700k

Leuchtmittelangabe GU10

GU10 max 35W; opt. LED

Leuchtmittlempfehlung

Art. Nr. 8-211

LED ~4W ~230lm ~2.700k



Schirmfarben für Silk (Chinz) Shade colors for Silk (Chinz)

- SI-100DB
- SI-100RO
- SI-100HB
- SI-100GB
- SI-100TK
- SI-100GR
- SI-100O
- SI-100V
- SI-100S
- SI-100W
- SI-100R
- SI-100GU
- SI-100BR
- SI-100OL

Schirmfarben für Speed (Chinz) Shade colors for Speed (Chinz)

- SP-100DB
- SP-100RO
- SP-100HB
- SP-100GB
- SP-100TK
- SP-100GR
- SP-100O
- SP-100V
- SP-100S
- SP-100W
- SP-100R
- SP-100GU
- SP-100BR
- SP-100OL



Schirmfarben für Brick (Chinz) Shade colors for Brick (Chinz)

- BR-100DB
- BR-100RO
- BR-100HB
- BR-100GB
- BR-100TK
- BR-100GR
- BR-100O
- BR-100V
- BR-100S
- BR-100W
- BR-100R
- BR-100GU
- BR-100BR
- BR-100OL

Schirmfarben für Game (Chinz) Shade colors for Game (Chinz)

- GA-100DB
- GA-100RO
- GA-100HB
- GA-100GB
- GA-100TK
- GA-100GR
- GA-100O
- GA-100V
- GA-100S
- GA-100W
- GA-100R
- GA-100GU
- GA-100BR
- GA-100OL

Schirmfarben für Wheel (Chinz) Shade colors for Wheel (Chinz)

- WE-100DB
- WE-100RO
- WE-100HB
- WE-100GB
- WE-100TK
- WE-100GR
- WE-100O
- WE-100V
- WE-100S
- WE-100W
- WE-100R
- WE-100GU
- WE-100BR
- WE-100OL

Sonderanfertigungen möglich:

Ab 10 Stück ist die Fertigung von Sonderfarben möglich oder z. B.:

- innen gold- oder silber kaschierte Schirme
 - Lackschirme
 - Seidenschirme
- Die Schirme werden per Hand gefertigt. Dadurch sind bestimmte individuelle Wünsche realisierbar.

Customized Shades are possible:

From 10 lamps up special requirements are available:

- golden or silver concealed shades
 - lacquer shades
 - silk shades
- All shades are handmade. Individual requirements can be realized.

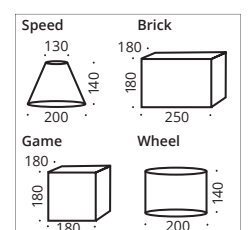
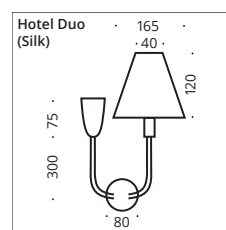
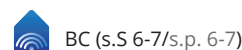

INDOOR





Flexlight Wall & Double Wall



Iglo

India

Pisa

Rio



Silk Double Wall

INDOOR

Iglo Wall	India Wall	Pisa Wall	Silk Wall	Rio Wall	Armlänge arm length in mm	Ausführung design
G9 ohne Leuchtmittel without lamp	G9 ohne Leuchtmittel without lamp	G9 ohne Leuchtmittel without lamp	E14 ohne Leuchtmittel without lamp	GU10 ohne Leuchtmittel without lamp		
3-4020101	3-4020102	3-4020103	3-4020105	3-4020117	200	chrome
3-4020201	3-4020202	3-4020203	3-4020205	3-4020217	200	nickel matt
3-4030101	3-4030102	3-4030103	3-4030105	3-4030117	300	chrome
3-4030201	3-4030202	3-4030203	3-4030205	3-4030217	300	nickel matt
3-4040101	3-4040102	3-4040103	3-4040105	3-4040117	400	chrome
3-4040201	3-4040202	3-4040203	3-4040205	3-4040217	400	nickel matt

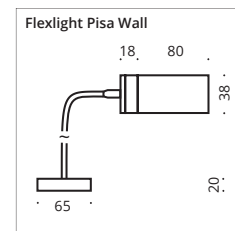

Iglo Double Wall	India Double Wall	Pisa Double Wall	Silk Double Wall	Rio Double Wall	Armlänge arm length in mm	Ausführung design
G9 ohne Leuchtmittel without lamp	G9 ohne Leuchtmittel without lamp	G9 ohne Leuchtmittel without lamp	E14 ohne Leuchtmittel without lamp	GU10 ohne Leuchtmittel without lamp		
3-4120101	3-4120102	3-4120103	3-4120105	3-4120117	200	chrome
3-4120201	3-4120202	3-4120203	3-4120205	3-4120217	200	nickel matt
3-4130101	3-4130102	3-4130103	3-4130105	3-4130117	300	chrome
3-4130201	3-4130202	3-4130203	3-4130205	3-4130217	300	nickel matt
3-4140101	3-4140102	3-4140103	3-4140105	3-4140117	400	chrome
3-4140201	3-4140202	3-4140203	3-4140205	3-4140217	400	nickel matt

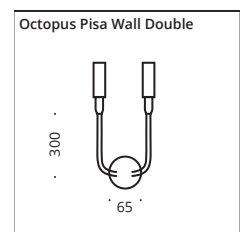

<p>G9 max. 33W ECO, optional LED Retrofit G9 max. 33W ECO, LED Retrofit optional</p>	<p>Leuchtmittlempfehlung: LED max. 3W/300lm/2.700K/dimmbar G Art Nr. 8-205 bulb recommendation: LED max. 3W/300Lm/2.700K/dimmable G Item No. 8-205</p>
<p>E14 max. 20W, optional LED Retrofit E14 max. 20W, LED Retrofit optional</p>	<p>Leuchtmittlempfehlung: LED max. 6W/470lm/2.700K G Art. Nr. 8-524 bulb recommendation: LED max. 6W/470Lm/2.700K G Item No. 8-524</p>
<p>GU10 max. 35W, optional LED Retrofit GU10 max. 35W, LED Retrofit optional</p>	<p>Leuchtmittlempfehlung: LED max. 4W/230lm/2.700K G Art. Nr. 8-211 bulb recommendation: LED max. 4W/230Lm/2.700K G Item No. 8-211</p>

Umbau zum Spiegeleinbau, conversion for mirror mounting
180° Reflektor optional für Glas Pisa, 180° baffle optional for glass Pisa
"Touch me" Dimmer, "Touch me" dimmer
Kippschalereinbau, dip switch fitting
Weitere Schirm-Farben für die Silk finden Sie auf der Einklappseite. You can find more colors for the silk shades on the fold in page.

Art.-Nr. 9-3002 chrom (chrome), Art.-Nr. 9-3009 nickelmatt (nickel matt)
Art.-Nr. 9-204
Art.-Nr. -D
Art.-Nr. -K



Glasslight Wall Pisa Double



Glass- & Spotlight Wall

INDOOR



Iglo



Pisa

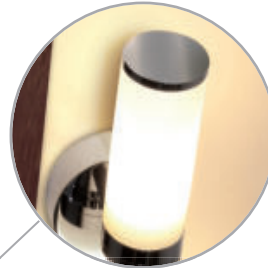

Pisa Double IP44



India



Rio



Pisa Double



Bulb

Iglo G9 ohne Leuchtmittel without lamp	India G9 ohne Leuchtmittel without lamp	Pisa G9 ohne Leuchtmittel without lamp	Rio GU10 ohne Leuchtmittel without lamp	Ausführung design
2-400101 2-400201	2-400102 2-400202	2-400103 2-400203	2-400117 2-400217	chrome nickel matt



Pisa Double G9 ohne Leuchtmittel without lamp	Pisa Double IP44 G9 ohne Leuchtmittel without lamp	Bulb G9 ohne Leuchtmittel without lamp	Ausführung design
2-400130 2-400230	2-400130 IP44 2-400230 IP44	2-400132 2-400232	chrome nickel matt

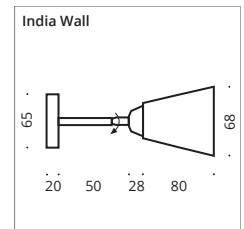
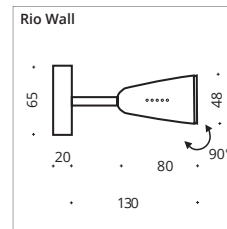

G9 max. 33W ECO, optional LED Retrofit G9 max. 33W ECO, LED Retrofit optional	Leuchtmittlempfehlung: LED max. 3W/300lm/2.700K/dimmbar G Art. Nr. 8-205 bulb recommendation: LED max. 3W/300lm/2.700K/dimmable G Item No. 8-205
GU10 max. 35W, optional LED Retrofit GU10 max. 35W, LED Retrofit optional	Leuchtmittlempfehlung: LED max. 4W/230lm/2.700K G Art. Nr. 8-211 bulb recommendation: LED max. 4W/230lm/2.700K G Item No. 8-211

Umbau zum Spiegeleinbau, conversion for mirror mounting Art.-Nr. 9-3002 chrom (chrome), 9-3009 nickelmatt (nickel matt)
 180° Reflektor optional für Glas Pisa, 180° baffle optional for glass Pisa Art.-Nr. 9-204
 "Touch me" Dimmer, "Touch me" dimmer Art.-Nr. -D
 Kippschaltereinbau, dip switch fitting Art.-Nr. -K



STECKERLEUCHTEN

PLUG LAMPS



Puk Mini Fexlight Plug 179



Glass- & Spotlight Flex 181



Glass- & Spotlight Plug 183



Puk Mini Flexlight Plug



Puk Mini Flexlight Plug

Die praktische Plugleuchte mit Pukkopf ist überall dort einsetzbar, wo eine Steckdose ist. Die Gläser/Linsen und Farbfilter werden separat dazubestellt.

The convenient plug light with Puk head can be used wherever there is a power socket. Glasses/Lenses and color filters for separate order.

INDOOR

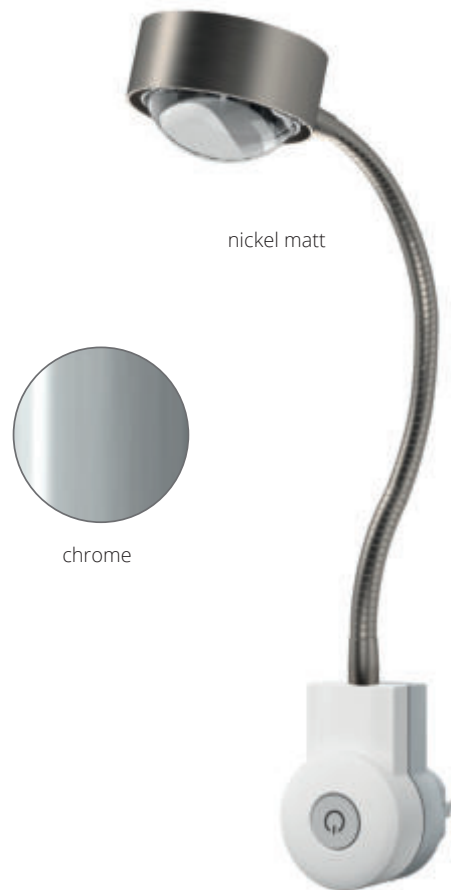

nickel matt

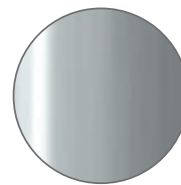

chrome

Puk Flexlight LED 2 x 8W ~1.200lm ~2.700k	Puk Flexlight G9 Fassung	Armlänge arm length in mm	Gehäuse body
3-3220114-LED	3-3220114	200	chrome
3-3220214-LED	3-3220214	200	nickel matt
3-3230114-LED	3-3230114	300	chrome
3-3230214-LED	3-3230214	300	nickel matt
3-3240114-LED	3-3240114	400	chrome
3-3240214-LED	3-3240214	400	nickel matt

▶ Ohne Zubehör. Bestell-Artikelnummern für Linse, Glas, Farbfilter und die Konfigurationsempfehlung auf der Einklapppseite!

▶ Without accessories: Order item-no. for lens, glass, color filter and the recommended Configuration are on the fold-in page!

G9 max. 33W ECO, optional LED Retrofit
 G9 max. 33W ECO, LED Retrofit optional

Leuchtmittelpfehlung: LED max. 3W/300lm/2.700K/dimmbar Art Nr. 8-205
 bulb recommendation: LED max. 3W/300lm/2.700K/dimmable Item No. 8-205

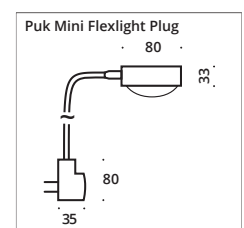





Flexlight Plug

INDOOR



Iglo



India



Pisa



Rio



Silk

	Iglo	India	Pisa	Silk	Rio	Armlänge arm length in mm	Ausführung design
	G9 ohne Leuchtmittel without lamp	G9 ohne Leuchtmittel without lamp	G9 ohne Leuchtmittel without lamp	E14 ohne Leuchtmittel without lamp	GU10 ohne Leuchtmittel without lamp		
●	3-3220101	3-3220102	3-3220103	3-3220105	3-3220117	200	chrome
●	3-3220201	3-3220202	3-3220203	3-3220205	3-3220217	200	nickel matt
●	3-3230101	3-3230102	3-3230103	3-3230105	3-3230117	300	chrome
●	3-3230201	3-3230202	3-3230203	3-3230205	3-3230217	300	nickel matt
●	3-3240101	3-3240102	3-3240103	3-3240105	3-3240117	400	chrome
●	3-3240201	3-3240202	3-3240203	3-3240205	3-3240217	400	nickel matt

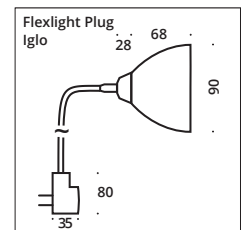

C (s.S 6-7/s.p. 6-7)

G9 max. 33W ECO, optional LED Retrofit G9 max. 33W ECO, LED Retrofit optional	Leuchtmittlempfehlung: LED max. 3W/300lm/2.700K/dimmbar Art. Nr. 8-205 bulb recommendation: LED max. 3W/300Lm/2.700K/dimmable Item No. 8-205
E14 max. 20W, optional LED Retrofit E14 max. 20W, LED Retrofit optional	Leuchtmittlempfehlung: LED max. 6W/470lm/2.700K Art. Nr. 8-524 bulb recommendation: LED max. 6W/470Lm/2.700K Item No. 8-524
GU10 max. 35W, optional LED Retrofit GU10 max. 35W, LED Retrofit optional	Leuchtmittlempfehlung: LED max. 4W/230lm/2.700K Art. Nr. 8-211 bulb recommendation: LED max. 4W/230Lm/2.700K Item No. 8-211

180° Reflektor optional für Glas Pisa, 180° baffle optional for glass Pisa Art.-Nr. 9-204

Weitere Schirm-Farben für die Silk finden Sie auf der Einklappseite. You can find more colors for the silk shades on the fold-in page.



Spotlight Plug Rio



Glass- & Spotlight Plug

INDOOR



Pisa



Rio



Bulb

Pisa	Rio	Bulb	Ausführung design
G9 ohne Leuchtmittel without lamp	GU10 ohne Leuchtmittel without lamp	G9 ohne Leuchtmittel without lamp	
2-320103 2-320203	2-320117 2-320217	2-320132 2-320232	chrome nickel matt
			C (s.S 6-7/s.p. 6-7)

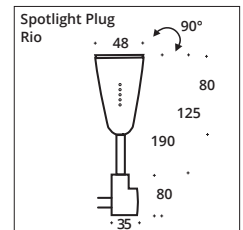

G9 max. 33W ECO, optional LED Retrofit
 G9 max. 33W ECO, LED Retrofit optional

Leuchtmittlempfehlung: LED max. 3W/300lm/2.700K/dimmbar Art Nr. 8-205
 bulb recommendation: LED max. 3W/300Lm/2.700K/dimmable Item No. 8-205

GU10 max. 35W, optional LED Retrofit
 GU10 max. 35W, LED Retrofit optional

Leuchtmittlempfehlung: LED max. 4W/230lm/2.700K
 bulb recommendation: LED max. 4W/230Lm/2.700K Art. Nr. 8-211
 Item No. 8-211

180° Reflektor optional für Glas Pisa, 180° baffle optional for glass Pisa Art.-Nr. 9-204



Puk Maxx Long Double

PENDELLEUCHTEN

PENDULAR LAMPS



Puk Mini Long One 187
Puk Maxx Long One 189
Puk Meg Maxx Long One 191



Puk Mini Long Double 187
Puk Maxx Long Double 189



Puk Mini Drop 193
Puk Maxx Drop 195
Puk Meg Maxx Drop 197



Puk Mini Quartett 199
Puk Maxx Quartett 201



Puk Mini Sixtett 199
Puk Maxx Sixtett 201



Puk Mini Choice Long One 203
Puk Maxx Choice Long One 205



Puk Mini Choice Drop 207
Puk Maxx Choice Drop 209



Puk Mini Crown S 211
Puk Maxx Crown S 211



Puk Mini Crown M 213
Puk Maxx Crown M 213



Puk Mini Crown L 215
Puk Maxx Crown L 215



Puk Mini Crown XL 217
Puk Maxx Crown XL 217



Puk Mini Line S 219
Puk Maxx Line S 219



Puk Mini Line M 221
Puk Maxx Line M 221



Puk Mini Line L 223
Puk Maxi Line L 223



Sun Swing 225



Choice Sun Swing 227



Foxx Swing 229



Pela 231
Pela Quadro 231



Pela Choice 233
Pela Quadro Choice 233



Look at me 235
Look at me Trio 235



Look at me Choice 237



Puk Mini Long Double



Puk Mini Long One & Long Double \varnothing 80

Pendelleuchte, Hochvolt Halogen oder LED Power, dimmbar. Pendellänge ca. 1.300 mm, Standard-Textilkabel in anthrazit.

Pendant luminaire, high voltage halogen or LED power, with one or two heads, dimmable. Pendant length approx. 1,300 mm. Textile cable in anthracite as standard.

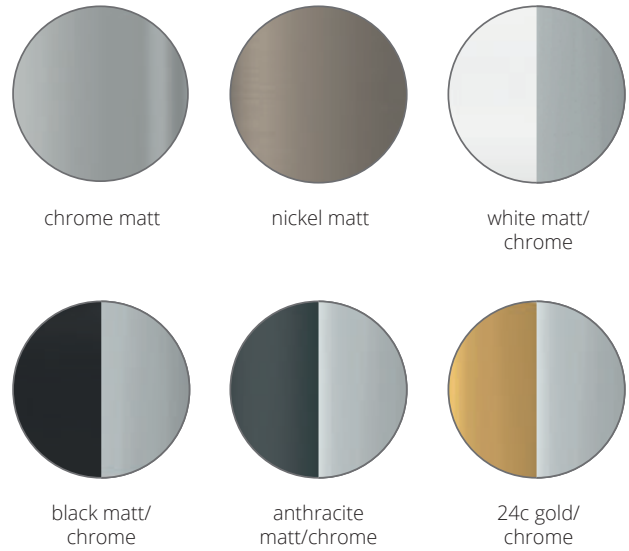

INDOOR

Puk Mini Long LED G ~2.700k, 1/4 x 8W	Puk Mini Long G9 Fassung	B x Pendellänge mm w x pendular length mm	Gehäuse body
One ~600lm downlight	One downlight		
5-08001-1-LED	5-08001-1	80 x 1.300	chrome matt
5-08002-1-LED	5-08002-1	80 x 1.300	chrome
5-08003-1-LED	5-08003-1	80 x 1.300	nickel matt
5-08002-1-LED-22	5-08002-1-22	80 x 1.300	white matt/chrome
5-08002-1-LED-02	5-08002-1-02	80 x 1.300	black matt/chrome
5-08002-1-LED-23	5-08002-1-23	80 x 1.300	anthracite/chrome
5-08006-1-LED	5-08006-1	80 x 1.300	24 carat gold plated/chr.
Double ~2.400lm up- & downlight	Double up- & downlight		
5-08001-2-LED	5-08001-2	200 x 1.300	chrome matt
5-08002-2-LED	5-08002-2	200 x 1.300	chrome
5-08003-2-LED	5-08003-2	200 x 1.300	nickel matt
5-08002-2-LED-22	5-08002-2-22	200 x 1.300	white matt/chrome
5-08002-2-LED-02	5-08002-2-02	200 x 1.300	black matt/chrome
5-08002-2-LED-23	5-08002-2-23	200 x 1.300	anthracite/chrome
5-08006-2-LED	5-08006-2	200 x 1.300	24 carat gold plated/chr.



Optional Kabelvarianten. Optional cable.



Chrom Teile/ chrome parts
 Gepulverte Teile/ powder-coating

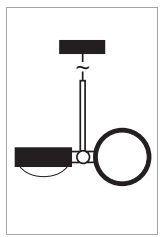
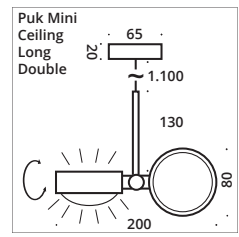
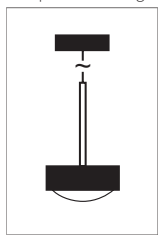
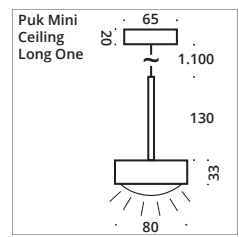

5-07951 Kabelverlängerung lfd. Meter cable extension per meter

▶ Ohne Zubehör. Bestell-Artikelnummern für Linse, Glas, Farbfilter und die Konfigurationsempfehlung auf der Einklappseite!

▶ Without accessories: Order item-no. for lens, glass, color filter and the recommended Configuration are on the fold-in page!

G9 max. 33W, optional LED Retrofit
 G9 max. 33W, LED Retrofit optional

Leuchtmittelempfehlung: LED max. 3W/300lm/2.700K/dimmbar **G** Art Nr. 8-205
 bulb recommendation: LED max. 3W/300lm/2.700K/dimmable **G** Item No. 8-205

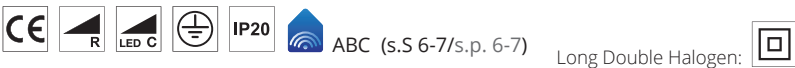

Long Double Halogen:





Puk Maxx Long One & Long Double \varnothing 120

Pendelleuchte, Hochvolt Halogen oder LED Power, mit ein oder zwei Köpfen dimmbar. Pendellänge ca. 1.300 mm, Standard-Textilkabel in anthrazit.

Pendant luminaire, high voltage halogen or LED power, with one or two heads, dimmable. Pendant length approx. 1,300 mm. Textile cable in anthracite as standard.

INDOOR

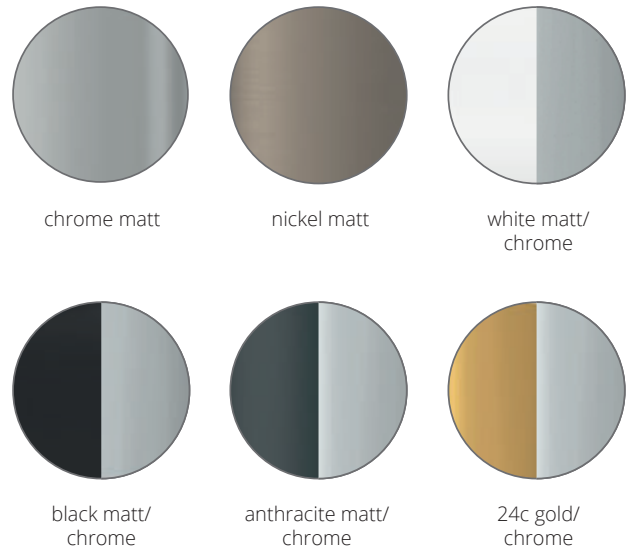

Puk Maxx LED G ~2.700k 1/4 x 12W	Puk Maxx G9 Fassung	B x Pendellänge in mm w x pendular length in mm	Gehäuse body
Long One ~900lm, downlight	Long One up- & downlight		
5-38001	5-38001-H	120 x 1.300	chrome matt
5-38002	5-38002-H	120 x 1.300	chrome
5-38003	5-38003-H	120 x 1.300	nickel matt
5-38002-22	5-38002-H-22	120 x 1.300	white matt/chrome
5-38002-02	5-38002-H-02	120 x 1.300	black matt/chrome
5-38002-23	5-38002-H-23	120 x 1.300	anthracite/chrome
5-38006	5-38006-H	120 x 1.300	24 carat gold plated/chr.
Long Double ~3.600lm	Long Double		
5-38021	5-38021-H	280 x 1.300	chrome matt
5-38022	5-38022-H	280 x 1.300	chrome
5-38023	5-38023-H	280 x 1.300	nickel matt
5-38022-22	5-38022-H-22	280 x 1.300	white matt/chrome
5-38022-02	5-38022-H-02	280 x 1.300	black matt/chrome
5-38022-23	5-38022-H-23	280 x 1.300	anthracite/chrome
5-38026	5-38026-H	280 x 1.300	24 carat gold plated/chr.



Optional Kabelvarianten.
Optional cable.



Chrom Teile/
chrome parts
 Gepulverte Teile/
powder-coating

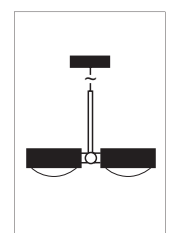
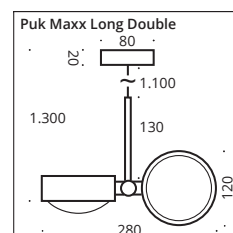
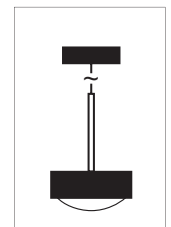
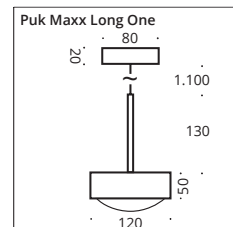

5-07951 Kabelverlängerung lfd. Meter cable extension per meter

▶ Ohne Zubehör. Bestell-Artikelnummern für Linse, Glas, Farbfilter und die Konfigurationsempfehlung auf der Einklappseite!



▶ Without accessories: Order item-no. for lens, glass, color filter and the recommended Configuration are on the fold-in page!

G9 max. 33W, optional LED Retrofit

G9 max. 33W, LED Retrofit optional

Leuchtmittelempfehlung: LED max. 3W/300lm/2.700K/dimmbar **G** Art Nr. 8-205
bulb recommendation: LED max. 3W/300Lm/2.700K/dimmable **G** Item No. 8-205







Puk Meg Maxx Long One ø 160

Pendelleuchte, Hochvolt Halogen oder LED Power, dimmbar, mit Metallabdeckung »up«. »Down« optional bestückbar mit Linse oder Glas. Pendellänge ca. 1.300 mm, Standard-Textilkabel in anthrazit.

Pendant luminaire, high voltage halogen or LED power, dimmable. with metal cover "up". "Down" can be optionally equipped with lens or glass. Pendant length approx. 1,300 mm. Textile cable in anthracite as standard.

INDOOR

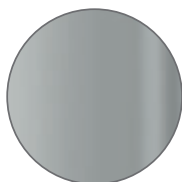

chrome matt



nickel matt

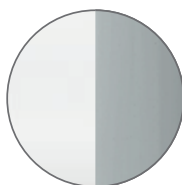

white matt/
chrome

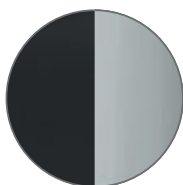

black matt/
chrome

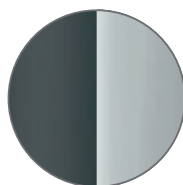

anthracite matt/
chrome

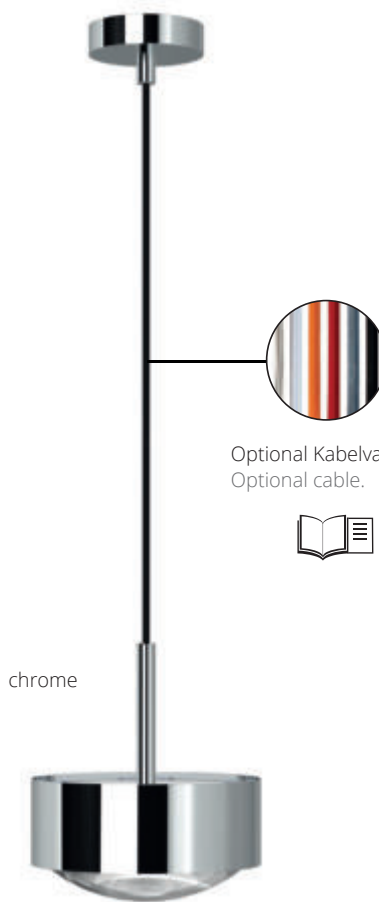

Optional Kabelvarianten.
Optional cable.



chrome

Puk Meg Maxx Long One LED	Puk Meg Maxx Long One G9 Fassung	Kopf ø head ø in mm	Gehäuse body
LED: G 16W ~2.400lm ~2.700k			
5-50001	5-50001-H	160	chrome matt
5-50002	5-50002-H	160	chrome
5-50003	5-50003-H	160	nickel matt
5-50002-22	5-50002-H-22	160	white matt/chr.
5-50002-02	5-50002-H-02	160	black matt/chr.
5-50002-23	5-50002-H-23	160	anthracite matt/chr.

5-07951 Kabelverlängerung 1 m, Cable extension 1 m

▶ Ohne Zubehör. Bestell-Artikelnummern für Linse, Glas, Farbfilter und die Konfigurationsempfehlung auf der Einklappseite!



▶ Without accessories: Order item-no. for lens, glass, color filter and the recommended Configuration are on the fold-in page!

G9 max. 33W, optional LED Retrofit

G9 max. 33W, LED Retrofit optional

Leuchtmittelpfehlung: LED max. 3W/300lm/2.700K/dimmbar **G** Art Nr. 8-205
 bulb recommendation: LED max. 3W/300Lm/2.700K/dimmable **G** Item No. 8-205



Chrom Teile/
chrome parts
 Gepulverte Teile/
powder-coating

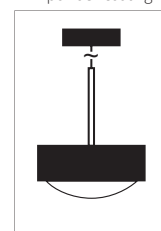
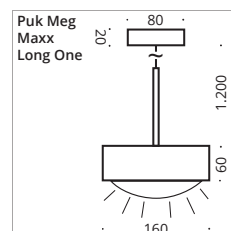





Puk Mini Drop ø 80

Pendelleuchte mit einem oder drei Köpfen. Erhältlich in LED oder Halogen. Pendellänge ca. 1.300 mm, Standard-Textilkabel in anthrazit.

Pendant luminaire with one or 3 heads. Available in high-voltage halogen or LED. Pendant length approx. 1,300 mm. Textile cable in anthracite as standard.

INDOOR

Puk Mini Drop Solo

Puk Drop LED G	Puk Drop G9 Fassung	Kopf ø Head ø in mm	Gehäuse body
2 x 8W, ~600lm ~2.700k			
5-06001	5-06001-H	80	chrome matt
5-06002	5-06002-H	80	chrome
5-06003	5-06003-H	80	nickel matt
5-06002-22	5-06002-H-22	80	white matt/chr.
5-06002-02	5-06002-H-02	80	black matt/chr.
5-06002-23	5-06002-H-23	80	anthracite matt/chr.
5-07951 Kabelverlängerung 1 m, cable extension 1 m			
▶ Ohne Zubehör. Bestell-Artikelnummern für Linse, Glas, Farbfilter und die Konfigurationsempfehlung auf der Einklappseite!			
▶ Without accessories: Order item-no. for lens, glass, color filter and the recommended Configuration are on the fold-in page!			
G9 max. 33W, optional LED Retrofit			
G9 max. 33W, LED Retrofit optional			
LME: LED max. 3W/300lm/2.700K/dimmbar		Art Nr. 8-205	
bulb recom.: LED max. 3W/300Lm/2.700K/dimmable		Item No. 8-205	

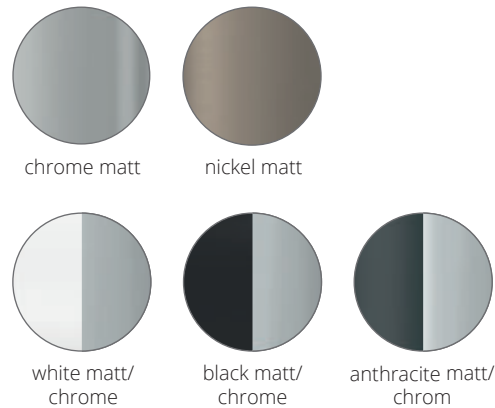

Puk Mini Drop Trio

Puk Drop LED G	Puk Drop G9 Fassung	Baldachin ø Baldachin ø in mm	Gehäuse body
6x 8W, ~1.800lm ~2.700k			
5-060031	5-060031-H	200	chrome matt
5-060032	5-060032-H	200	chrome
5-060033	5-060033-H	200	nickel matt
5-060032-22	5-060032-H-22	200	white matt/chr.
5-060032-02	5-060032-H-02	200	black matt/chr.
5-060032-23	5-060032-H-23	200	anthracite matt/chr.
5-07953 Kabelverlängerung 3 x 1 m, cable extension 3 x 1 m			
▶ Ohne Zubehör. Bestell-Artikelnummern für Linse, Glas, Farbfilter und die Konfigurationsempfehlung auf der Einklappseite!			
▶ Without accessories: Order item-no. for lens, glass, color filter and the recommended Configuration are on the fold-in page!			
G9 max. 33W, optional LED Retrofit			
G9 max. 33W, LED Retrofit optional			
LME: LED max. 3W/300lm/2.700K/dimmbar		Art Nr. 8-205	
bulb recom.: LED max. 3W/300Lm/2.700K/dimmable		Item No. 8-205	

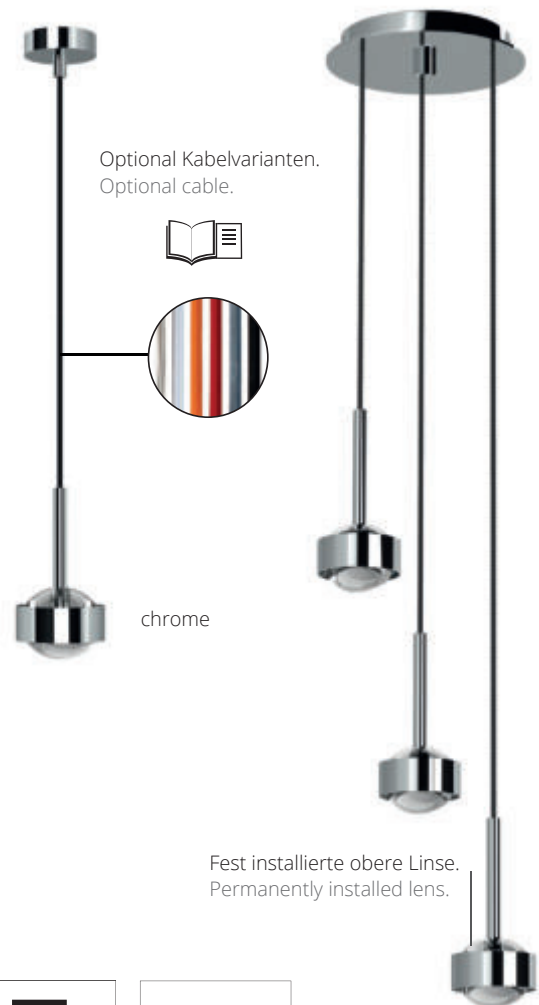

ABCD (s.S 6-7/s.p. 6-7)

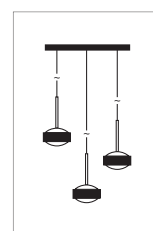
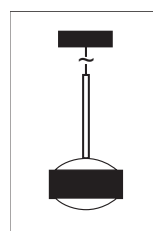
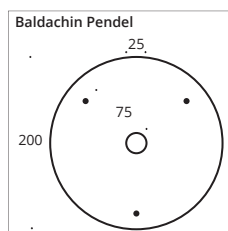
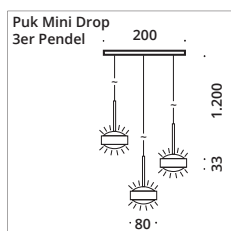
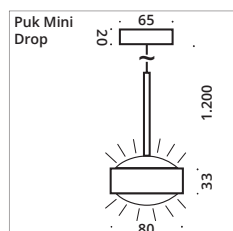

Chrom Teile/chrome parts
 Gepulverte Teile/powder-coating





Puk Maxx Drop ø 120

Pendelleuchte mit einem oder drei Köpfen. Erhältlich in LED oder Halogen. Pendellänge ca. 1.300 mm, Standard-Textilkabel in anthrazit.

Pendant luminaire with one or 3 heads. Available in high-voltage halogen or LED. Pendant length approx. 1,300 mm. Textile cable in anthracite as standard.

INDOOR

Puk Maxx Drop Solo

Puk Maxx Drop LED G 2 x 12W, ~1.800lm ~2.700k	Puk Maxx Drop G9 Fassung	Kopf ø Head ø in mm	Gehäuse body
5-36001	5-36001-H	120	chrome matt
5-36002	5-36002-H	120	chrome
5-36003	5-36003-H	120	nickel matt
5-36002-22	5-36002-H-22	120	white matt/chr.
5-36002-02	5-36002-H-02	120	black matt/chr.
5-36002-23	5-36002-H-23	120	anthracite matt/chr.

5-07951 Kabelverlängerung 1 m, cable extension 1 m

▶ Ohne Zubehör. Bestell-Artikelnummern für Linse, Glas, Farbfilter und die Konfigurationsempfehlung auf der Einklappseite!

▶ Without accessories: Order item-no. for lens, glass, color filter and the recommended Configuration are on the fold-in page!

G9 max. 33W, optional LED Retrofit
 G9 max. 33W, LED Retrofit optional

LME: LED max. 3W/300lm/2.700K/dimmbar **G** Art Nr. 8-205
 bulb recom.: LED max. 3W/300Lm/2.700K/dimmable **G** Item No. 8-205

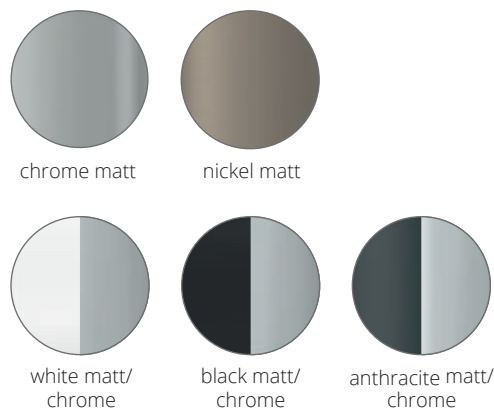

Puk Maxx Drop Trio

Puk Maxx Drop LED G 6 x 12W, ~5.400lm, ~2.700k	Puk Maxx Drop G9 Fassung	Baldachin ø Baldachin ø in mm	Gehäuse body
5-360031	5-360031-H	200	chrome matt
5-360032	5-360032-H	200	chrome
5-360033	5-360033-H	200	nickel matt
5-360032-22	5-360032-H-22	200	white matt/chr.
5-360032-02	5-360032-H-02	200	black matt/chr.
5-360032-23	5-360032-H-23	200	anthracite matt/chr.

5-07953 Kabelverlängerung 3 x 1 m, cable extension 3 x 1 m

▶ Ohne Zubehör. Bestell-Artikelnummern für Linse, Glas, Farbfilter und die Konfigurationsempfehlung auf der Einklappseite!

▶ Without accessories: Order item-no. for lens, glass, color filter and the recommended Configuration are on the fold-in page!

G9 max. 33W, optional LED Retrofit
 G9 max. 33W, LED Retrofit optional

LME: LED max. 3W/300lm/2.700K/dimmbar **G** Art Nr. 8-205
 bulb recom.: LED max. 3W/300Lm/2.700K/dimmable **G** Item No. 8-205



ABCD (s.S 6-7/s.p. 6-7)

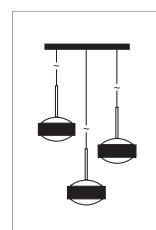
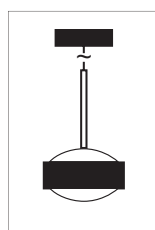
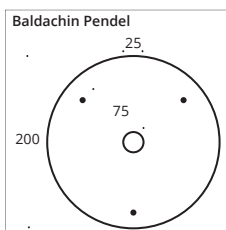
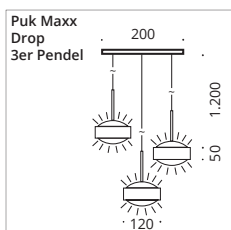
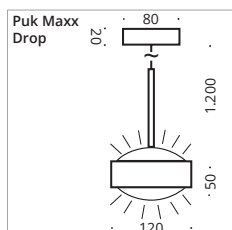

Chrom Teile/chrome parts
 Gepulverte Teile/powder-coating



Puk Meg Maxx Drop Trio



Puk Meg Maxx Drop ø 160

Pendelleuchte mit einem oder drei Köpfen. Erhältlich in LED oder mit G9 Fassung für den Einsatz von LED Retrofit oder Halogen. Pendellänge ca. 1.300 mm, Standard-Textilkabel in anthrazit.

Pendant luminaire with one or 3 heads. Available in LED or with G9 socket for the use of LED retrofit or halogen luminaires. Pendant length approx. 1,300 mm. Textile cable in anthracite as standard.

INDOOR

Puk Meg Maxx Drop Solo

Puk Meg Maxx Drop LED G 2 x 16W ~2.400lm ~2.700k	Puk Meg Maxx Drop G9 Fassung	Kopf ø Head ø in mm	Gehäuse body
5-56001	5-56001-H	160	chrome matt
5-56002	5-56002-H	160	chrome
5-56003	5-56003-H	160	nickel matt
5-56002-22	5-56002-H-22	160	white matt/chr.
5-56002-02	5-56002-H-02	160	black matt/chr.
5-56002-23	5-56002-H-23	160	anthracite/chr.
5-07951 Kabelverlängerung 1 m, cable extension 1 m			

▶ Ohne Zubehör. Bestell-Artikelnummern für Linse, Glas, Farbfilter und die Konfigurationsempfehlung auf der Einklappseite!
 ▶ Without accessories: Order item-no. for lens, glass, color filter and the recommended Configuration are on the fold-in page!

G9 max. 33W, optional LED Retrofit
 G9 max. 33W, LED Retrofit optional
 LME: LED max. 3W/300lm/2.700K/dimmbar Art Nr. 8-205
 bulb recom.: LED max. 3W/300Lm/2.700K/dimmable Item No. 8-205

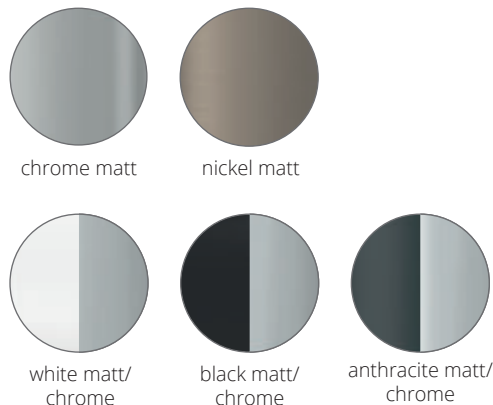

Puk Meg Maxx Drop Trio

Puk Meg Maxx Drop LED G 6 x 16W ~7.200lm ~2.700k	Puk Meg Maxx Drop G9 Fassung	Baldachin ø Baldachin ø in mm	Gehäuse body
5-560031	5-560031-H	200	chrome matt
5-560032	5-560032-H	200	chrome
5-560033	5-560033-H	200	nickel matt
5-560032-22	5-560032-H-22	200	white matt/chr.
5-560032-02	5-560032-H-02	200	black matt/chr.
5-560032-23	5-560032-H-23	200	anthracite/chr.
5-07953 Kabelverlängerung 3 x 1 m, cable extension 3 x 1 m			

▶ Ohne Zubehör. Bestell-Artikelnummern für Linse, Glas, Farbfilter und die Konfigurationsempfehlung auf der Einklappseite!
 ▶ Without accessories: Order item-no. for lens, glass, color filter and the recommended Configuration are on the fold-in page!

G9 max. 33W, optional LED Retrofit
 G9 max. 33W, LED Retrofit optional
 LME: LED max. 3W/300lm/2.700K/dimmbar Art Nr. 8-205
 bulb recom.: LED max. 3W/300Lm/2.700K/dimmable Item No. 8-205



CE R LED C IP20 ABCD (s.S 6-7/s.p. 6-7)

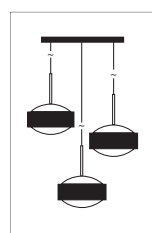
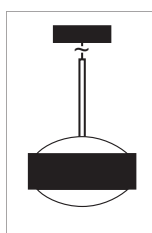
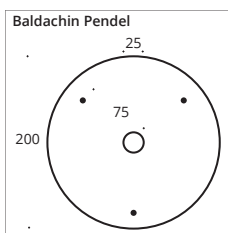
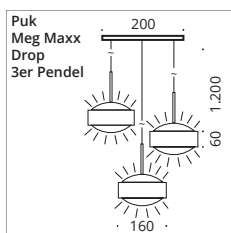
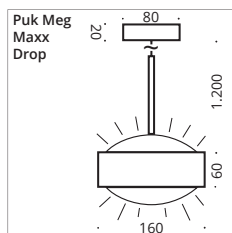

□ Chrom Teile/chrome parts
 ■ Gepulverte Teile/powder-coating





Puk Mini Quartett & Puk Sixtett ø 80

Pendelleuchte, Hochvolt Halogen oder LED Power, dimmbar. Pendellänge ca. 1.300 mm, Standard-Textilkabel in anthrazit.

Pendant luminaire in high voltage halogen or LED Power, dimmable. Pendant length approx. 1,300 mm. Textile cable in anthracite as standard.

INDOOR



chrome

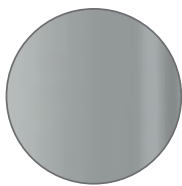

chrome matt

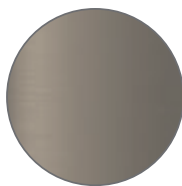

nickel matt

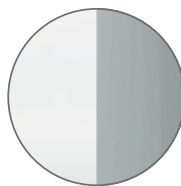

white matt/
chrome

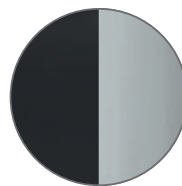

black matt/
chrome

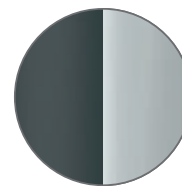

anthracite matt/
chrome

Puk Mini LED ~2.700k	Puk Mini G9 Fassung	L x Pendellänge l x pendular length in mm	Gehäuse body
Quartett 8 x 8W, ~4.800lm	Quartett		
5-07801-4-LED	5-07801-4	805 x 2.000	chrome matt
5-07802-4-LED	5-07802-4	805 x 2.000	chrome
5-07803-4-LED	5-07803-4	805 x 2.000	nickel matt
5-07802-4-LED-22	5-07802-4-22	805 x 2.000	white matt/chr.
5-07802-4-LED-02	5-07802-4-02	805 x 2.000	black matt/chr.
5-07802-4-LED-23	5-07802-4-23	805 x 2.000	anthracite matt/chr.
Sixtett 12 x 8W, ~7.200lm	Sixtett		
5-071201-6-LED	5-071201-6	1.260 x 2.000	chrome matt
5-071202-6-LED	5-071202-6	1.260 x 2.000	chrome
5-071203-6-LED	5-071203-6	1.260 x 2.000	nickel matt
5-071202-6-LED-22	5-071202-6-22	1.260 x 2.000	white matt/chr.
5-071202-6-LED-02	5-071202-6-02	1.260 x 2.000	black matt/chr.
5-071202-6-LED-23	5-071202-6-23	1.260 x 2.000	anthracite matt/chr.



Optional Kabelvarianten.
Optional cable.



► Ohne Zubehör. Bestell-Artikelnummern für Linse, Glas, Farbfilter und die Konfigurationsempfehlung auf der Einklappseite!

► Without accessories: Order item-no. for lens, glass, color filter and the recommended Configuration are on the fold-in page!



G9 max. 33W, optional LED Retrofit

G9 max. 33W, LED Retrofit optional

Leuchtmittelempfehlung: LED max. 3W/300lm/2.700K/dimmbar Art Nr. 8-205
bulb recommendation: LED max. 3W/300Lm/2.700K/dimmable Item No. 8-205

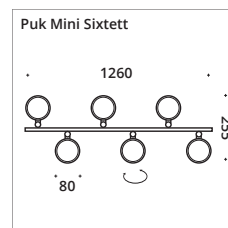
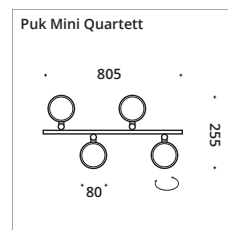

Chrom Teile/
chrome parts
 Gepulverte Teile/
powder-coating

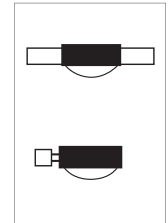





Puk Maxx Quartett & Sixtett ø 120

Pendelleuchte mit drehbaren Köpfen, Hochvolt Halogen oder LED Power. Pendellänge ca. 1.300 mm, Standard-Textilkabel in anthrazit.

Pendant luminaires in high voltage halogen or LED Power, dimmable. Pendant length approx. 1,300 mm. Textile cable in anthracite as standard.

INDOOR



chrome

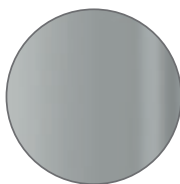

chrome matt



nickel matt

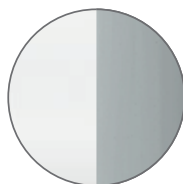

white matt/
chrome

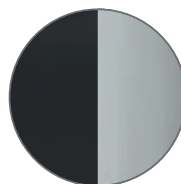

black matt/
chrome

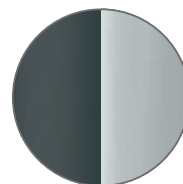

anthracite matt/
chrome

Puk Maxx LED ~2.700k	Puk Maxx G9 Fassung	Pendellänge x L pendular length x l in mm	Gehäuse body
Quartett 8 x 12W, ~7.200lm			
<ul style="list-style-type: none"> 5-37801-4 5-37802-4 5-37803-4 5-37802-4-22 5-37802-4-02 5-37802-4-23 	Quartett 5-37801-4-H 5-37802-4-H 5-37803-4-H 5-37802-4-H-22 5-37802-4-H-02 5-37802-4-H-23	2.000 x 805 2.000 x 805 2.000 x 805 2.000 x 805 2.000 x 805 2.000 x 805	chrome matt chrome nickel matt white matt/chr. black matt/chr. anthracite matt/chr.
Sixtett 12 x 12W, ~10.800lm			
<ul style="list-style-type: none"> 5-371201-6 5-371202-6 5-371203-6 5-371202-6-22 5-371202-6-02 5-371202-6-23 	Sixtett 5-371201-6-H 5-371202-6-H 5-371203-6-H 5-371202-6-H-22 5-371202-6-H-02 5-371202-6-H-23	2.000 x 1.260 2.000 x 1.260 2.000 x 1.260 2.000 x 1.260 2.000 x 1.260 2.000 x 1.260	chrome matt chrome nickel matt white matt/chr. black matt/chr. anthracite matt/chr.

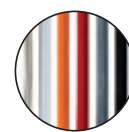

Optional Kabelvarianten.
Optional cable.



▶ Ohne Zubehör. Bestell-Artikelnummern für Linse, Glas, Farbfilter und die Konfigurationsempfehlung auf der Einklappseite!



▶ Without accessories: Order item-no. for lens, glass, color filter and the recommended Configuration are on the fold-in page!

G9 max. 33W, optional LED Retrofit

G9 max. 33W, LED Retrofit optional

Leuchtmittelempfehlung: LED max. 3W/300lm/2.700K/dimmbar Art Nr. 8-205
bulb recommendation: LED max. 3W/300Lm/2.700K/dimmable Item No. 8-205

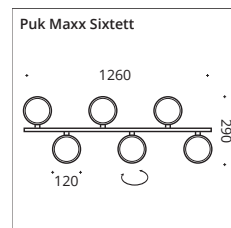
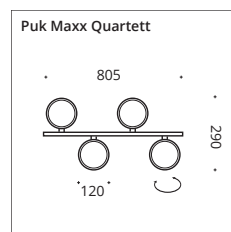

Chrom Teile/
chrome parts
 Gepulverte Teile/
powder-coating

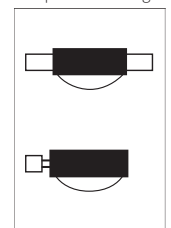





Puk Mini Choice Long One ø 80

Der Lichtbalken ist bestückt mit Puk Mini Long One Pendelleuchten in Hochvolt Halogen oder LED. Zur Direktmontage an der Decke. Pendellänge ca. 1.300 mm, Standard-Textilkabel in anthrazit.

The light bar is equipped with Puk Mini Long One pendant luminaires in high voltage halogen or LED. For direct mounting on the ceiling. Pendant length approx. 1,300 mm. Textile cable in anthracite as standard.

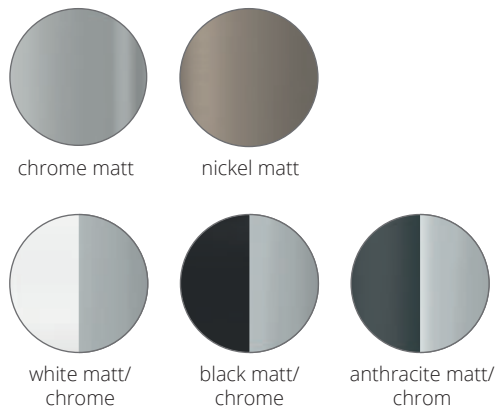

INDOOR

G9 Fassung

450 mm L 2 Köpfe/heads	850 mm L 3 Köpfe/heads	1.050 mm L 4 Köpfe/heads	1.250 mm L 4 Köpfe/heads	Gehäuse body
8-6054021-H	8-6058031-H	8-60510041-H	8-60512041-H	chrome matt
8-6054022-H	8-6058032-H	8-60510042-H	8-60512042-H	chrome
8-6054023-H	8-6058033-H	8-60510043-H	8-60512043-H	nickel matt
8-6054022-H-22	8-6058032-H-22	8-60510042-H-22	8-60512042-H-22	white matt/chr.
8-6054022-H-02	8-6058032-H-02	8-60510042-H-02	8-60512042-H-02	black matt/chr.
8-6054022-H-23	8-6058032-H-23	8-60510042-H-23	8-60512042-H-23	anthracite matt/chr.

Farbig gepulverter Lichtbalken auf Anfrage. Color powdered metal rail on request.

- ▶ Ohne Zubehör. Bestell-Artikelnummern für Linse, Glas, Farbfilter und die Konfigurationsempfehlung auf der Einklappseite!
- ▶ Without accessories: Order item-no. for lens, glass, color filter and the recommended Configuration are on the fold-in page!

- 💡 G9 max. 33W, optional LED Retrofit
- 💡 G9 max. 33W, LED Retrofit optional

- 💡 Leuchtmittelempfehlung: LED max. 3W/300lm/2.700K/dimmbar **G** Art Nr. 8-205
- 💡 bulb recommendation: LED max. 3W/300Lm/2.700K/dimmable **G** Item No. 8-205

LED

450 mm L 2 Köpfe/heads G	850 mm L 3 Köpfe/heads G	1.050 mm L 4 Köpfe/heads G	1.250 mm L 4 Köpfe/heads G	Gehäuse body
2 x 8W, ~1.200lm, ~2.700k	3 x 8W, ~1.800lm, ~2.700k	4 x 8W, ~2.400lm, ~2.700k	4 x 8W, ~2.400lm, ~2.700k	
8-6054021	8-6058031	8-60510041	8-60512041	chrome matt
8-6054022	8-6058032	8-60510042	8-60512042	chrome
8-6054023	8-6058033	8-60510043	8-60512043	nickel matt
8-6054022-22	8-6058032-22	8-60510042-22	8-60512042-22	white matt/chr.
8-6054022-02	8-6058032-02	8-60510042-02	8-60512042-02	black matt/chr.
8-6054022-23	8-6058032-23	8-60510042-23	8-60512042-23	anthracite matt/chr.

Farbig gepulverter Lichtbalken auf Anfrage. Color powdered metal rail on request.

- ▶ Ohne Zubehör. Bestell-Artikelnummern für Linse, Glas, Farbfilter und die Konfigurationsempfehlung auf der Einklappseite!
- ▶ Without accessories: Order item-no. for lens, glass, color filter and the recommended Configuration are on the fold-in page!

Sonderanfertigung:

Art-Nr. 8-600 Kürzung auf Maß
Item No. 8-600 Customized lengths

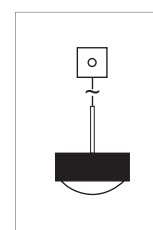
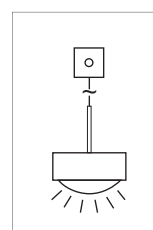
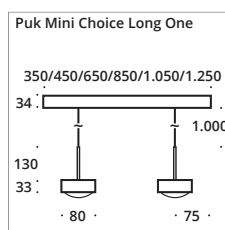

☐ Chrom Teile/
chrome parts
■ Gepulverte Teile/
powder-coating





Puk Maxx Choice Long One ø 120

Der Lichtbalken ist bestückt mit Puk Maxx Long One Pendelleuchten in Hochvolt Halogen oder LED. Zur Direktmontage an der Decke. Pendellänge ca. 1.300 mm, Standard-Textilkabel in anthrazit.

The light bar is equipped with Puk Maxx Long One pendant luminaires in high voltage halogen or LED. For direct mounting on the ceiling. Pendant length approx. 1,300 mm. Textile cable in anthracite as standard.

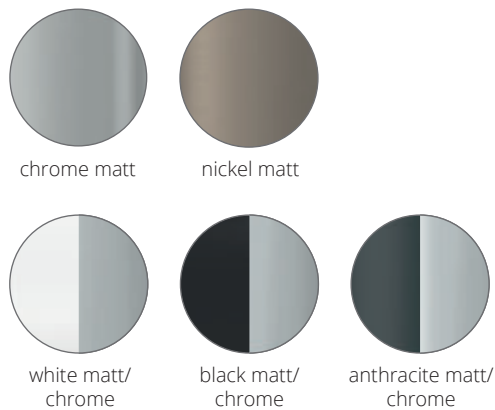

INDOOR

G9 Fassung

450 mm L 2 Köpfe/heads	850 mm L 3 Köpfe/heads	1.050 mm L 4 Köpfe/heads	1.250 mm L 4 Köpfe/heads	Gehäuse body
8-6854021-H	8-6858031-H	8-68510041-H	8-68512041-H	chrome matt
8-6854022-H	8-6858032-H	8-68510042-H	8-68512042-H	chrome
8-6854023-H	8-6858033-H	8-68510043-H	8-68512043-H	nickel matt
8-6854022-H-22	8-6858032-H-22	8-68510042-H-22	8-68512042-H-22	white matt/chr.
8-6854022-H-02	8-6858032-H-02	8-68510042-H-02	8-68512042-H-02	black matt/chr.
8-6854022-H-23	8-6858032-H-23	8-68510042-H-23	8-68512042-H-23	anthracite matt/chr.

Farbig gepulverter Lichtbalken auf Anfrage. Color powdered metal rail on request.

- ▶ Ohne Zubehör. Bestell-Artikelnummern für Linse, Glas, Farbfilter und die Konfigurationsempfehlung auf der Einklappseite!
- ▶ Without accessories: Order item-no. for lens, glass, color filter and the recommended Configuration are on the fold-in page!

💡 G9 max. 33W, optional LED Retrofit
💡 G9 max. 33W, LED Retrofit optional

💡 Leuchtmittelempfehlung: LED max. 3W/300lm/2.700K/dimmbar **G** Art Nr. 8-205
💡 bulb recommendation: LED max. 3W/300lm/2.700K/dimmable **G** Item No. 8-205

LED

450 mm L 2 Köpfe/heads G 2 x 12W, ~1.800lm, ~2.700k	850 mm L 3 Köpfe/heads G 3 x 12W, ~2.700lm, ~2.700k	1.050 mm L 4 Köpfe/heads G 4 x 12W, ~3.600lm, ~2.700k	1.250 mm L 4 Köpfe/heads G 4 x 12W, ~3.600lm, ~2.700k	Gehäuse body
8-6854021	8-6858031	8-68510041	8-68512041	chrome matt
8-6854022	8-6858032	8-68510042	8-68512042	chrome
8-6854023	8-6858033	8-68510043	8-68512043	nickel matt
8-6854022-22	8-6858032-22	8-68510042-22	8-68512042-22	white matt/chr.
8-6854022-02	8-6858032-02	8-68510042-02	8-68512042-02	black matt/chr.
8-6854022-23	8-6858032-23	8-68510042-23	8-68512042-23	anthracite matt/chr.

Farbig gepulverter Lichtbalken auf Anfrage. Color powdered metal rail on request.

- ▶ Ohne Zubehör. Bestell-Artikelnummern für Linse, Glas, Farbfilter und die Konfigurationsempfehlung auf der Einklappseite!
- ▶ Without accessories: Order item-no. for lens, glass, color filter and the recommended Configuration are on the fold-in page!

Sonderanfertigung:

Art-Nr. 8-600 Kürzung auf Maß
Item No. 8-600 Customized lengths

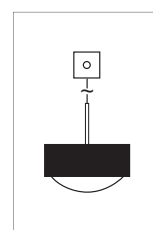
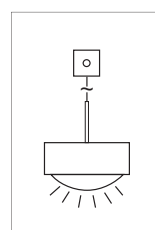
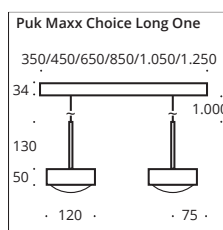

☐ Chrom Teile/
chrome parts
■ Gepulverte Teile/
powder-coating





Puk Mini Choice Drop ø 80

Der Lichtbalken ist bestückt mit Puk Mini Drop Pendelleuchten in Hochvolt Halogen oder LED. Zur Direktmontage an der Decke. Pendellänge ca. 1.300 mm, Standard-Textilkabel in anthrazit.

The light bar is equipped with Puk Mini Drop pendant luminaires in high voltage halogen or LED. For direct mounting on the ceiling. Pendant length approx. 1,300 mm. Textile cable in anthracite as standard.

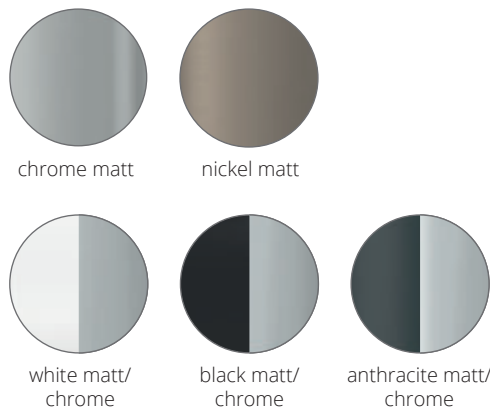

INDOOR

G9 Fassung

450 mm L 2 Köpfe/heads	850 mm L 3 Köpfe/heads	1.050 mm L 4 Köpfe/heads	1.250 mm L 4 Köpfe/heads	Gehäuse body
8-6074021-H	8-6078031-H	8-60710041-H	8-60712041-H	chrome matt
8-6074022-H	8-6078032-H	8-60710042-H	8-60712042-H	chrome
8-6074023-H	8-6078033-H	8-60710043-H	8-60712043-H	nickel matt
8-6074022-H-22	8-6078032-H-22	8-60710042-H-22	8-60712042-H-22	white matt/chr.
8-6074022-H-02	8-6078032-H-02	8-60710042-H-02	8-60712042-H-02	black matt/chr.
8-6074022-H-23	8-6078032-H-23	8-60710042-H-23	8-60712042-H-23	anthracite matt/chr.

Farbig gepulverter Lichtbalken auf Anfrage. Color powdered metal rail on request.

- ▶ Ohne Zubehör. Bestell-Artikelnummern für Linse, Glas, Farbfilter und die Konfigurationsempfehlung auf der Einklappseite!
- ▶ Without accessories: Order item-no. for lens, glass, color filter and the recommended Configuration are on the fold-in page!

G9 max. 33W, optional LED Retrofit
G9 max. 33W, LED Retrofit optional

Leuchtmittelempfehlung: LED max. 3W/300lm/2.700K/dimmbar **G** Art Nr. 8-205
bulb recommendation: LED max. 3W/300lm/2.700K/dimmable **G** Item No. 8-205

LED

450 mm L 2 Köpfe/heads G	850 mm L 3 Köpfe/heads G	1.050 mm L 4 Köpfe/heads G	1.250 mm L 4 Köpfe/heads G	Gehäuse body
4 x 8W, ~2.400lm, ~2.700k	6 x 8W, ~3.600lm, ~2.700k	8 x 8W, ~4.800lm, ~2.700k	8 x 8W, ~4.800lm, ~2.700k	
8-6074021	8-6078031	8-60710041	8-60712041	chrome matt
8-6074022	8-6078032	8-60710042	8-60712042	chrome
8-6074023	8-6078033	8-60710043	8-60712043	nickel matt
8-6074022-22	8-6078032-22	8-60710042-22	8-60712042-22	white matt/chr.
8-6074022-02	8-6078032-02	8-60710042-02	8-60712042-02	black matt/chr.
8-6074022-23	8-6078032-23	8-60710042-23	8-60712042-23	anthracite matt/chr.

Farbig gepulverter Lichtbalken auf Anfrage. Color powdered metal rail on request.

- ▶ Ohne Zubehör. Bestell-Artikelnummern für Linse, Glas, Farbfilter und die Konfigurationsempfehlung auf der Einklappseite!
- ▶ Without accessories: Order item-no. for lens, glass, color filter and the recommended Configuration are on the fold-in page!

Sonderanfertigung:

Art-Nr. 8-600 Kürzung auf Maß
Item No. 8-600 Customized lengths

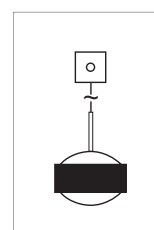
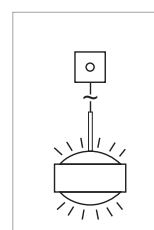
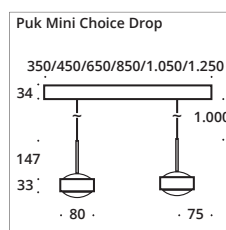

□ Chrom Teile/
chrome parts
■ Gepulverte Teile/
powder-coating





Puk Maxx Choice Drop \varnothing 120

Der Lichtbalken ist bestückt mit Puk Maxx Drop Pendelleuchten in Hochvolt Halogen oder LED. Zur Direktmontage an der Decke. Pendellänge ca. 1.300 mm, Standard-Textilkabel in anthrazit.

The light bar is equipped with Puk Maxx Drop pendant luminaires in high voltage halogen or LED. For direct mounting on the ceiling. Pendant length approx. 1,300 mm. Textile cable in anthracite as standard.

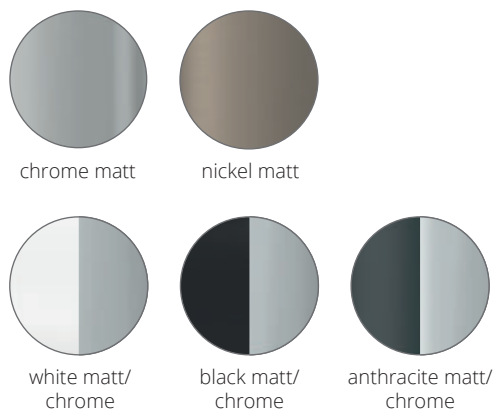

INDOOR

G9 Fassung

450 mm L 2 Köpfe/heads	850 mm L 3 Köpfe/heads	1.050 mm L 4 Köpfe/heads	1.250 mm L 4 Köpfe/heads	Gehäuse body
8-6874021-H	8-6878031-H	8-68710041-H	8-68712041-H	chrome matt
8-6874022-H	8-6878032-H	8-68710042-H	8-68712042-H	chrome
8-6874023-H	8-6878033-H	8-68710043-H	8-68712043-H	nickel matt
8-6874022-H-22	8-6878032-H-22	8-68710042-H-22	8-68712042-H-22	white matt/chr.
8-6874022-H-02	8-6878032-H-02	8-68710042-H-02	8-68712042-H-02	black matt/chr.
8-6874022-H-23	8-6878032-H-23	8-68710042-H-23	8-68712042-H-23	anthracite matt/chr.

Farbig gepulverter Lichtbalken auf Anfrage. Color powdered metal rail on request.

- ▶ Ohne Zubehör. Bestell-Artikelnummern für Linse, Glas, Farbfilter und die Konfigurationsempfehlung auf der Einklappseite!
- ▶ Without accessories: Order item-no. for lens, glass, color filter and the recommended Configuration are on the fold-in page!

G9 max. 33W, optional LED Retrofit
 G9 max. 33W, LED Retrofit optional

Leuchtmittelempfehlung: LED max. 3W/300lm/2.700K/dimmbar **G** Art Nr. 8-205
 bulb recommendation: LED max. 3W/300lm/2.700K/dimmable **G** Item No. 8-205

LED

450 mm L 2 Köpfe/heads G	850 mm L 3 Köpfe/heads G	1.050 mm L 4 Köpfe/heads G	1.250 mm L 4 Köpfe/heads G	Gehäuse body
4 x 12W, ~3.600lm, ~2.700k	6 x 12W, ~5.400lm, ~2.700k	8 x 12W, ~7.200lm, ~2.700k	8 x 12W, ~7.200lm, ~2.700k	
8-6874021	8-6878031	8-68710041	8-68712041	chrome matt
8-6874022	8-6878032	8-68710042	8-68712042	chrome
8-6874023	8-6878033	8-68710043	8-68712043	nickel matt
8-6874022-22	8-6878032-22	8-68710042-22	8-68712042-22	white matt/chr.
8-6874022-02	8-6878032-02	8-68710042-02	8-68712042-02	black matt/chr.
8-6874022-23	8-6878032-23	8-68710042-23	8-68712042-23	anthracite matt/chr.

Farbig gepulverter Lichtbalken auf Anfrage. Color powdered metal rail on request.

- ▶ Ohne Zubehör. Bestell-Artikelnummern für Linse, Glas, Farbfilter und die Konfigurationsempfehlung auf der Einklappseite!
- ▶ Without accessories: Order item-no. for lens, glass, color filter and the recommended Configuration are on the fold-in page!

Sonderanfertigung:

Art-Nr. 8-600 Kürzung auf Maß
 Item No. 8-600 Customized lengths

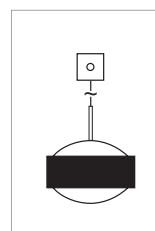
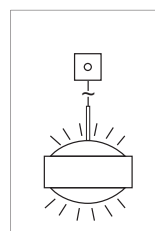
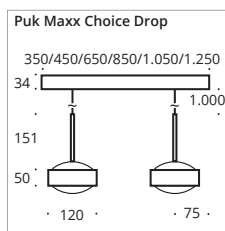

□ Chrom Teile/
chrome parts
 ■ Gepulverte Teile/
powder-coating





Puk Crown S ø 80/120

Die Puk Serie als exklusive Ringleuchte. Die Bestückung ist variierbar mit den Puk Mini und Puk Maxx Köpfen. In schlichtem eleganten Design mit LED oder Halogen bestückt, wird eine harmonische Raumausleuchtung geschaffen. Die Ringgröße S, mit drei Leuchtenköpfen, sorgt für eine optimale Beleuchtung kleinerer Tische oder Raumecken. Pendellänge ca. 1.300 mm, Standard-Textilkabel in anthrazit.

The Puk series as an exclusive ring luminaire. The fitting is variable with the Puk Mini and Puk Maxx heads. In a simple elegant design, equipped with LED or high-voltage halogen, a harmonious room illumination is created. The ring size S, with three luminaire heads, provides optimal lighting for tables or small room corners. Pendant length approx. 1300 mm, with textile cable in anthracite as standard.

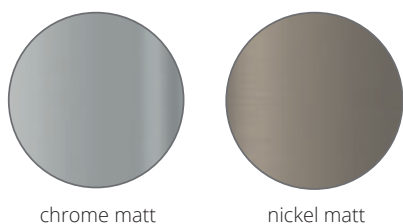

G9 Fassung

Puk Mini Crown G9 Fassung	Puk Maxx Crown G9 Fassung	Gehäuse body
S 400/560	S 400/560	
● 8-050341-H	● 8-350341-H	chrome matt
● 8-050342-H	● 8-350342-H	chrome
● 8-050343-H	● 8-350343-H	nickel matt

▶ Ohne Zubehör. Bestell-Artikelnummern für Linse, Glas, Farbfilter und die Konfigurationsempfehlung auf der Einklappseite!

▶ Without accessories: Order item-no. for lens, glass, color filter and the recommended Configuration are on the fold-in page!

💡 G9 max. 33W, optional LED Retrofit

💡 G9 max. 33W, LED Retrofit optional

💡 LME: LED max. 3W/300lm/2.700K/dimmbar Art Nr. 8-205

💡 bulb recom.: LED max. 3W/300Lm/2.700K/dimmable Item No. 8-205

LED

Puk Mini Crown LED	Puk Maxx Crown LED	Gehäuse body
6 x 8 W ~3.600lm ~2.700k	6 x 12 W ~5.400lm ~2.700k	
S 400/560	S 400/560	
● 8-050341-LED	● 8-350341-LED	chrome matt
● 8-050342-LED	● 8-350342-LED	chrome
● 8-050343-LED	● 8-350343-LED	nickel matt

▶ Ohne Zubehör. Bestell-Artikelnummern für Linse, Glas, Farbfilter und die Konfigurationsempfehlung auf der Einklappseite!

▶ Without accessories: Order item-no. for lens, glass, color filter and the recommended Configuration are on the fold-in page!

Sondergrößen auf Maß siehe Seite 330 – 339.

For special requirements, please look at page 330 – 339.

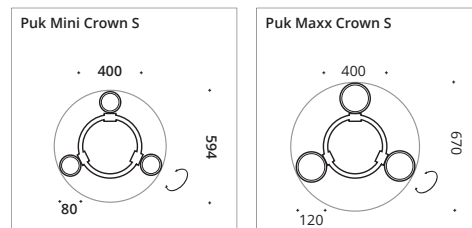

Kabellänge für Abhängung 2.000 mm (kürzbar)
Cable length for suspension 2.000 mm (can be shortened)







Puk Crown M ø 80/120

Die Puk Serie als exklusive Ringleuchte. Die Bestückung ist variierbar mit den Puk Mini und Puk Maxx Köpfen. In schlichtem eleganten Design mit LED oder Halogen bestückt, wird eine harmonische Raumausleuchtung geschaffen. Die Ringgröße M, mit vier Leuchtenköpfen, sorgt für eine optimale Beleuchtung von Esstischen oder partiellen Raumbereichen. Pendellänge ca. 1.300 mm, Standard-Textilkabel in anthrazit.

The Puk series as an exclusive ring luminaire. In a simple elegant design, equipped with LED or high-voltage halogen, a harmonious room illumination is created. The fitting is variable with the Puk Mini and Puk Maxx heads. The ring size M, with 4 luminaire heads, provides optimal lighting for dining tables or partial room areas. Pendant length approx. 1300 mm, with textile cable in anthracite as standard.

INDOOR

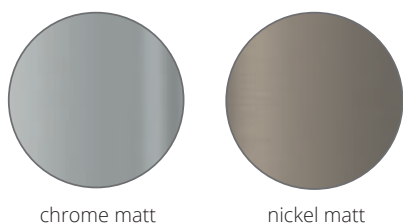

G9 Fassung

Puk Mini Crown G9 Fassung	Puk Maxx Crown G9 Fassung	Gehäuse body
M 700/860	M 700/860	
● 8-050471-H	8-350471-H	chrome matt
● 8-050472-H	8-350472-H	chrome
● 8-050473-H	8-350473-H	nickel matt

▶ Ohne Zubehör. Bestell-Artikelnummern für Linse, Glas, Farbfilter und die Konfigurationsempfehlung auf der Einklappseite!

▶ Without accessories: Order item-no. for lens, glass, color filter and the recommended Configuration are on the fold-in page!

💡 G9 max. 33W, optional LED Retrofit

💡 G9 max. 33W, LED Retrofit optional

💡 LME: LED max. 3W/300lm/2.700K/dimmbar Art Nr. 8-205
bulb recom.: LED max. 3W/300Lm/2.700K/dimmable Item No. 8-205

LED

Puk Mini Crown LED	Puk Maxx Crown LED	Gehäuse body
8 x 8 W ~4.800lm ~2.700k	8 x 12 W ~7.200lm ~2.700k	
M 700/860	M 700/860	
● 8-050471-LED	8-350471-LED	chrome matt
● 8-050472-LED	8-350472-LED	chrome
● 8-050473-LED	8-350473-LED	nickel matt

▶ Ohne Zubehör. Bestell-Artikelnummern für Linse, Glas, Farbfilter und die Konfigurationsempfehlung auf der Einklappseite!

▶ Without accessories: Order item-no. for lens, glass, color filter and the recommended Configuration are on the fold-in page!

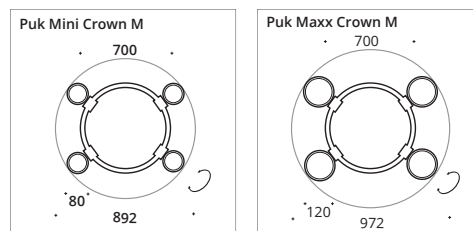

Kabellänge für Abhängung 2.000 mm (kürzbar)
Cable length for suspension 2.000 mm (can be shortened)

Sondergrößen auf Maß siehe Seite 330 – 339.
For special requirements, please look at page 330 – 339.







Puk Crown L ø 80/120

Die Puk Serie als exklusive Ringleuchte. Die Bestückung ist variabel mit den Puk Mini und Puk Maxx Köpfen. In schlichtem eleganten Design mit LED oder Halogen bestückt, wird eine harmonische Raumausleuchtung geschaffen. Die Ringgröße L, mit sechs Leuchtenköpfen, sorgt für eine optimale Beleuchtung großer Tische oder ganzer Räume. Pendellänge ca. 1.300 mm, Standard-Textilkabel in anthrazit als Standard.

The Puk series as an exclusive ring luminaire. The fitting is variable with the Puk Mini and Puk Maxx heads. In a simple elegant design, equipped with LED or high-voltage halogen, a harmonious room illumination is created. The ring size L, with 6 luminaire heads, provides optimal lighting for large tables or entire rooms. Pendant length approx. 1300 mm, with textile cable in anthracite as standard.

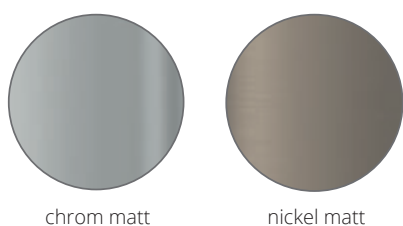

G9 Fassung

Puk Mini Crown G9 Fassung	Puk Maxx Crown G9 Fassung	Gehäuse body
L 1100/1260	L 1100/1260	
● 8-0506111-H	8-3506111-H	chrome matt
● 8-0506112-H	8-3506112-H	chrome
● 8-0506113-H	8-3506113-H	nickel matt

- ▶ Ohne Zubehör. Bestell-Artikelnummern für Linse, Glas, Farbfilter und die Konfigurationsempfehlung auf der Einklappseite!
- ▶ Without accessories: Order item-no. for lens, glass, color filter and the recommended Configuration are on the fold-in page!

💡 G9 max. 33W, optional LED Retrofit
💡 G9 max. 33W, LED Retrofit optional

💡 LME: LED max. 3W/300lm/2.700K/dimmbar **G** Art Nr. 8-205
💡 bulb recom.: LED max. 3W/300lm/2.700K/dimmable **G** Item No. 8-205

LED

Puk Mini Crown LED G	Puk Maxx Crown LED G	Gehäuse body
12 x 8 W ~7.200lm ~2.700k	12 x 12 W ~10.800lm ~2.700k	
L 1100/1260	L 1100/1260	
● 8-0506111-LED	8-3506111-LED	chrome matt
● 8-0506112-LED	8-3506112-LED	chrome
● 8-0506113-LED	8-3506113-LED	nickel matt

- ▶ Ohne Zubehör. Bestell-Artikelnummern für Linse, Glas, Farbfilter und die Konfigurationsempfehlung auf der Einklappseite!
- ▶ Without accessories: Order item-no. for lens, glass, color filter and the recommended Configuration are on the fold-in page!

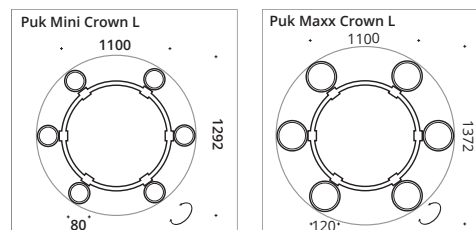

Kabellänge für Abhängung 5.000 mm (kürzbar)
Cable length for suspension 5.000 mm (can be shortened)

Sondergrößen auf Maß siehe Seite 330 – 339.
For special requirements, please look at page 330 – 339.





Puk Maxx Crown XL



Puk Crown XL ø 80/120

Die Puk Serie als exklusive Ringleuchte. Die Bestückung ist variierbar mit den Puk Mini und Puk Maxx Köpfen. Alle drei Ringe zusammengefügt zur Puk Crown XL mit insgesamt 13 Leuchtenköpfen ist diese Leuchte ideal für die Beleuchtung hoher Räume oder Hallen. Standard-Textilkabel in anthrazit.

The Puk series as an exclusive ring luminaire. The fitting is variable with the Puk Mini and Puk Maxx heads. All three rings combined to form the Puk Crown XL, with a total of 13 luminaire heads, this luminaire is ideal for lighting high rooms or entrance halls. With textile cable in anthracite as standard.

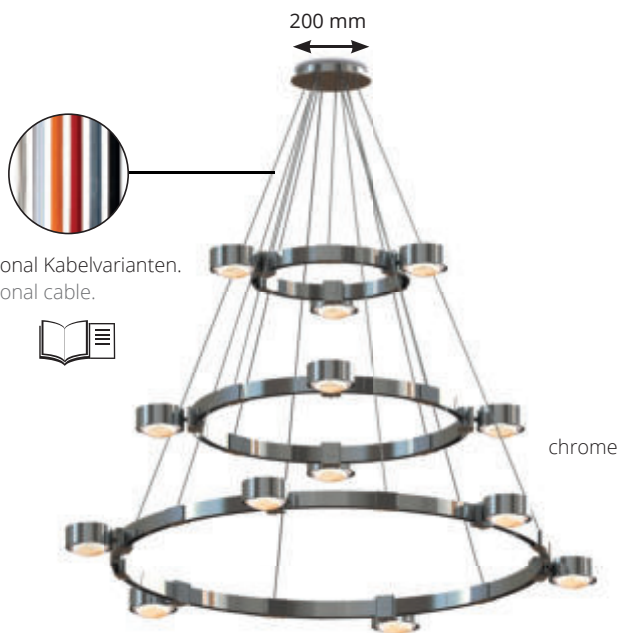
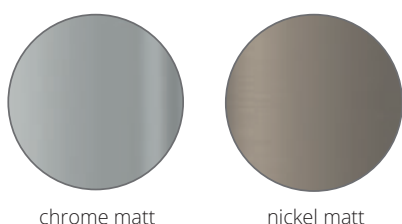

G9 Fassung S+M+L

Puk Mini Crown G9 Fassung	Puk Maxx Crown G9 Fassung	Gehäuse body
XL 1100/1260	XL 1100/1260	
● 8-0513111-H	● 8-3513111-H	chrome matt
● 8-0513112-H	● 8-3513112-H	chrome
● 8-0513113-H	● 8-3513113-H	nickel matt

- ▶ Ohne Zubehör. Bestell-Artikelnummern für Linse, Glas, Farbfilter und die Konfigurationsempfehlung auf der Einklappseite!
- ▶ Without accessories: Order item-no. for lens, glass, color filter and the recommended Configuration are on the fold-in page!



● G9 max. 33W, optional LED Retrofit
 ⚡ G9 max. 33W, LED Retrofit optional

● Leuchtmittelempfehlung: LED max. 3W/300lm/2.700K/dimmbar **G** Art Nr. 8-205
 ⚡ bulb recommendation: LED max. 3W/300Lm/2.700K/dimmable **G** Item No. 8-205

LED S+M+L

Puk Mini Crown LED G	Puk Maxx Crown LED G	Gehäuse body
26 x 8 W ~15.600lm ~2.700k	26 x 12 W ~23.400lm ~2.700k	
XL 1100/1260	XL 1100/1260	
● 8-0513111-LED	● 8-3513111-LED	chrome matt
● 8-0513112-LED	● 8-3513112-LED	chrome
● 8-0513113-LED	● 8-3513113-LED	nickel matt

- ▶ Ohne Zubehör. Bestell-Artikelnummern für Linse, Glas, Farbfilter und die Konfigurationsempfehlung auf der Einklappseite!
- ▶ Without accessories: Order item-no. for lens, glass, color filter and the recommended Configuration are on the fold-in page!

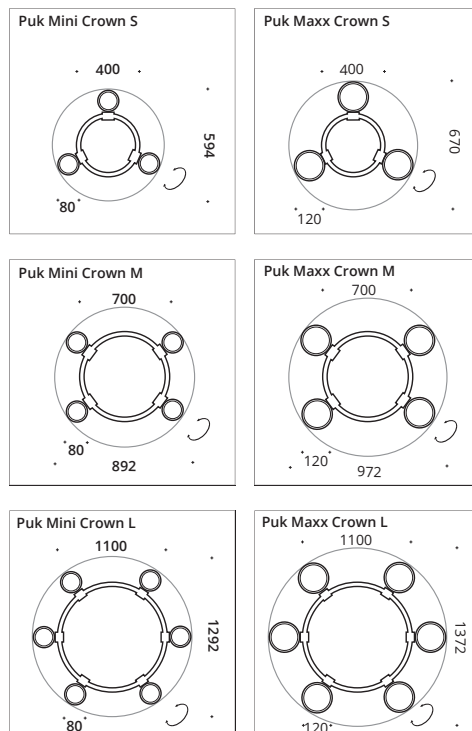

Kabellänge für Abhängung 5.000 mm (kürzbar)
 Cable length for suspension 5.000 mm (can be shortened)

Sondergrößen auf Maß siehe Seite 330 – 339.

For special requirements, please look at page 330 – 339.







Puk Line S ø 80/120

Puk Pendelleuchte mit Seilabhängung und parallelen Leuchtenköpfen. Die Schienen werden mit den Puk Mini oder Puk Maxx Größen bestückt. Hierbei sind beide Varianten mit LED und Halogen möglich. Die Größe S bietet Licht für kleine Tische oder partiell im Raum. Pendellänge ca. 1.300 mm, Standard-Textilkabel in anthrazit.

Pendant luminaire with wire suspension and parallel heads. The tracks are equipped with Puk Mini or Puk Maxx luminaire heads. Both versions are available with LED or high-voltage halogen. Size S provides light for small tables and partial room areas. Pendant length approx. 1300 mm, with textile cable in anthracite as standard.

INDOOR

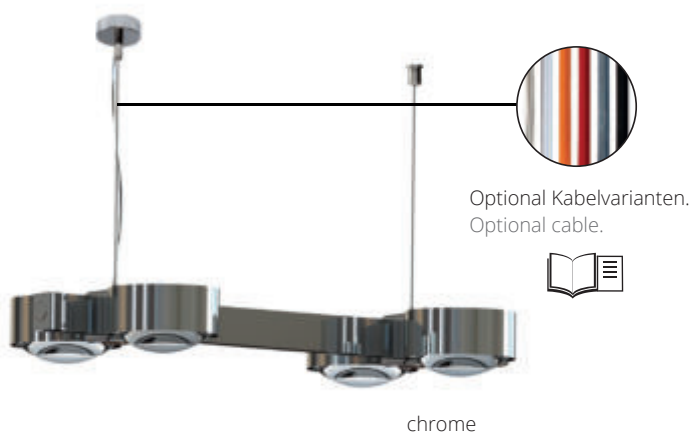
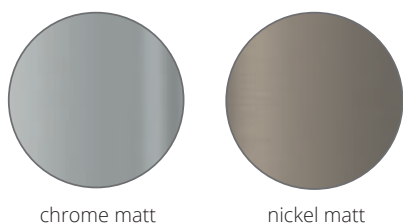

G9 Fassung

Puk Mini Line G9 Fassung	Puk Maxx Line G9 Fassung	Gehäuse body
S 800	S 800	
8-020461-H	8-320461-H	chrome matt
8-020462-H	8-320462-H	chrome
8-020463-H	8-320463-H	nickel matt

▶ Ohne Zubehör. Bestell-Artikelnummern für Linse, Glas, Farbfilter und die Konfigurationsempfehlung auf der Einklappseite!
 ▶ Without accessories: Order item-no. for lens, glass, color filter and the recommended Configuration are on the fold-in page!

💡 G9 max. 33W, optional LED Retrofit
 💡 G9 max. 33W, LED Retrofit optional

💡 Leuchtmittelempfehlung: LED max. 3W/300lm/2.700K/dimmbar **G** Art Nr. 8-205
 💡 bulb recommendation: LED max. 3W/300Lm/2.700K/dimmable **G** Item No. 8-205

LED

Puk Mini Line LED G	Puk Maxx Line LED G	Gehäuse body
8 x 8 W ~4.800lm ~2.700k	8 x 12 W ~7.200lm ~2.700k	
S 800	S 800	
8-020461-LED	8-320461-LED	chrome matt
8-020462-LED	8-320462-LED	chrome
8-020463-LED	8-320463-LED	nickel matt

▶ Ohne Zubehör. Bestell-Artikelnummern für Linse, Glas, Farbfilter und die Konfigurationsempfehlung auf der Einklappseite!
 ▶ Without accessories: Order item-no. for lens, glass, color filter and the recommended Configuration are on the fold-in page!

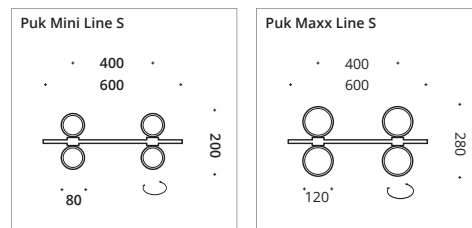

Kabellänge für Abhängung 2.000 mm (kürzbar)
Cable length for suspension 2.000 mm (can be shortened)

Sondergrößen auf Maß siehe Seite 310 – 319.
For special requirements, please look at page 310 – 319.







Puk Line M \varnothing 80/120

Puk Pendelleuchte mit Seilabhängung und parallelen Leuchtenköpfen. Die Schienen werden mit den Puk Mini oder Puk Maxx Größen bestückt. Hierbei sind beide Varianten mit LED und Halogen möglich. Die Größe M bietet Licht für Esstische oder Bereiche im Raum. Pendellänge ca. 1.300 mm, Standard-Textilkabel in anthrazit.

Pendant luminaire with wire suspension and parallel heads. The tracks are equipped with Puk Mini or Puk Maxx luminaire heads. Both versions are available with LED or high-voltage halogen. Size M provides light for dining tables or areas in the room that need to be partially illuminated. Pendant length approx. 1300 mm, with textile cable in anthracite as standard.

INDOOR

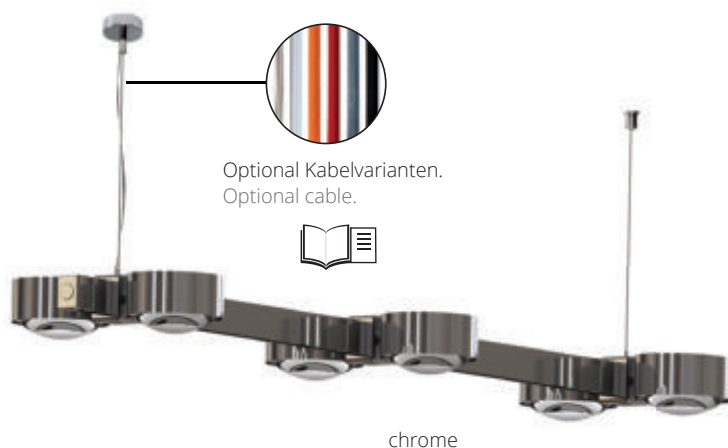
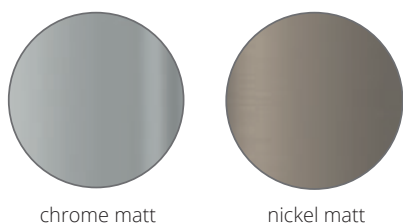

chrome

G9 Fassung

Puk Mini Line G9 Fassung	Puk Maxx Line G9 Fassung	Gehäuse body
M 1200	M 1200	
● 8-0206121-H	8-3206121-H	chrome matt
● 8-0206122-H	8-3206122-H	chrome
● 8-0206123-H	8-3206123-H	nickel matt

▶ Ohne Zubehör. Bestell-Artikelnummern für Linse, Glas, Farbfilter und die Konfigurationsempfehlung auf der Einklappseite!

▶ Without accessories: Order item-no. for lens, glass, color filter and the recommended Configuration are on the fold-in page!

💡 G9 max. 33W, optional LED Retrofit

💡 G9 max. 33W, LED Retrofit optional

💡 Leuchtmittelempfehlung: LED max. 3W/300lm/2.700K/dimmbar **G** Art Nr. 8-205

💡 bulb recommendation: LED max. 3W/300Lm/2.700K/dimmable **G** Item No. 8-205

LED

Puk Mini Line LED G	Puk Maxx Line LED G	Gehäuse body
12 x 8 W ~7.200lm ~2.700k	12 x 12 W ~10.800lm ~2.700k	
M 1200	M 1200	
● 8-0206121-LED	8-3206121-LED	chrome matt
● 8-0206122-LED	8-3206122-LED	chrome
● 8-0206123-LED	8-3206123-LED	nickel matt

▶ Ohne Zubehör. Bestell-Artikelnummern für Linse, Glas, Farbfilter und die Konfigurationsempfehlung auf der Einklappseite!

▶ Without accessories: Order item-no. for lens, glass, color filter and the recommended Configuration are on the fold-in page!

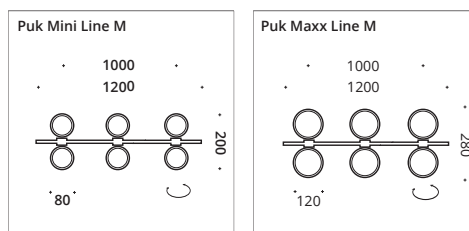

Kabellänge für Abhängung 2.000 mm (kürzbar)
Cable length for suspension 2.000 mm (can be shortened)

Sondergrößen auf Maß siehe Seite 310 – 319.
For special requirements, please look at page 310 – 319.







Puk Line L \varnothing 80/120

Puk Pendelleuchte mit Seilabhängung und parallelen Leuchtenköpfen. Die Schienen werden mit den Puk Mini oder Puk Maxx Größen bestückt. Hierbei sind beide Varianten mit LED und Halogen möglich. Die Größe L bietet Licht für große Tische oder ganze Räume. Pendellänge ca. 1.300 mm, Standard-Textilkabel in anthrazit.

Pendant luminaire with wire suspension and parallel heads. The tracks are equipped with Puk Mini or Puk Maxx luminaire heads. Both versions are available with LED or high-voltage halogen. Size L provides light for large tables or entire rooms. . Pendant length approx. 1300 mm, with textile cable in anthracite as standard.

INDOOR

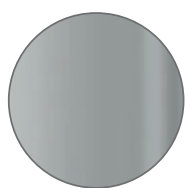

chrome matt



nickel matt

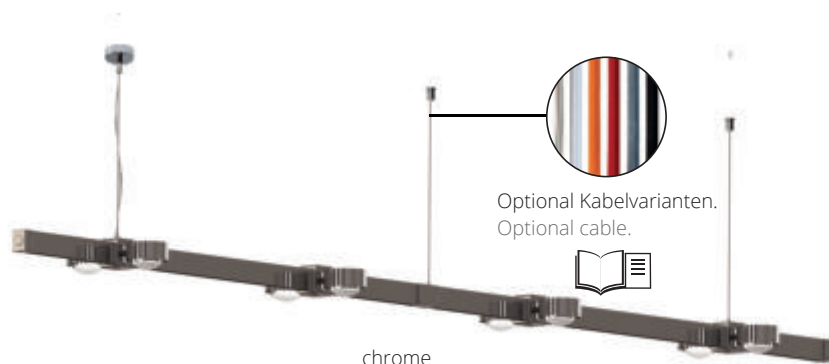

chrome

Optional Kabelvarianten.
Optional cable.



G9 Fassung

Puk Mini Line G9 Fassung	Puk Maxx Line G9 Fassung	Gehäuse body
L 2400	L 2400	
● 8-0208241-H	8-3208241-H	chrome matt
● 8-0208242-H	8-3208242-H	chrome
● 8-0208243-H	8-3208243-H	nickel matt

▶ Ohne Zubehör. Bestell-Artikelnummern für Linse, Glas, Farbfilter und die Konfigurationsempfehlung auf der Einklappseite!
▶ Without accessories: Order item-no. for lens, glass, color filter and the recommended Configuration are on the fold-in page!

● G9 max. 33W, optional LED Retrofit
● G9 max. 33W, LED Retrofit optional

● Leuchtmittelempfehlung: LED max. 3W/300lm/2.700K/dimmbar **G** Art Nr. 8-205
● bulb recommendation: LED max. 3W/300Lm/2.700K/dimmable **G** Item No. 8-205



LED

Puk Mini Line LED G	Puk Maxx Line LED G	Gehäuse body
16 x 8 W ~9.600lm ~2.700k	16 x 12 W ~14.400lm ~2.700k	
L 2400	L 2400	
● 8-0208241-LED	8-3208241-LED	chrome matt
● 8-0208242-LED	8-3208242-LED	chrome
● 8-0208243-LED	8-3208243-LED	nickel matt

▶ Ohne Zubehör. Bestell-Artikelnummern für Linse, Glas, Farbfilter und die Konfigurationsempfehlung auf der Einklappseite!
▶ Without accessories: Order item-no. for lens, glass, color filter and the recommended Configuration are on the fold-in page!

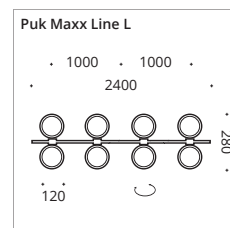
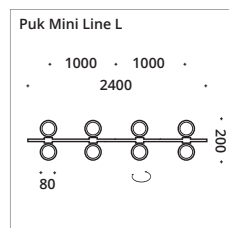

Kabellänge für Abhängung 2.000 mm (kürzbar)
Cable length for suspension 2.000 mm (can be shortened)

Sondergrößen auf Maß siehe Seite 310 – 319.
For special requirements, please look at page 310 – 319.







Sun Swing ø 90/130/210

Der Leuchtenkopf der LED Pendelleuchte Sun Swing Ceiling lässt sich in alle Richtungen über ein Kugelgelenk schwenken. Sie ist in den Durchmessern 90/130/210 mm als Up- oder Downlight erhältlich. Ob direkt oder indirekt, lässt sich das Licht dorthin lenken, wo es benötigt wird. Pendellänge ca. 1.300 mm, Standard-Textilkabel in anthrazit.

The luminaire head of the Sun Ceiling LED luminaires can be swivelled in all directions via a ball joint. It is available in the diameters 90/130/210 mm as uplight or downlight. Whether direct or indirect, the light can be directed to where it is needed. Pendant length approx. 1300 mm, with textile cable in anthracite as standard.

INDOOR

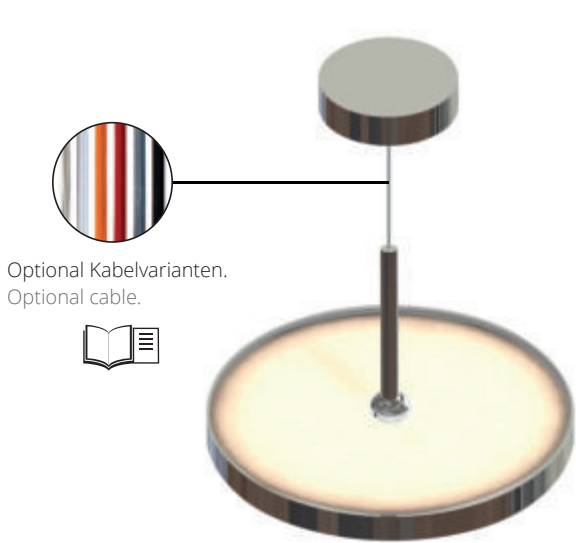

Optional Kabelvarianten.
Optional cable.

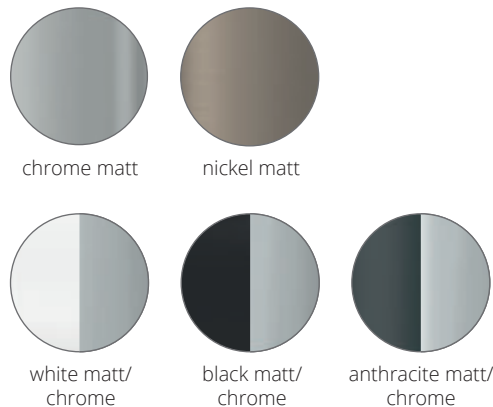

☐ Chrom Teile/
chrome parts
■ Gepulverte Teile/
powder-coating

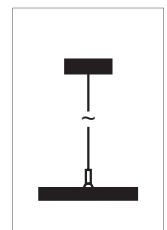

Sun Swing – Up Light

Up Light LED	Up Light LED	Up Light LED	Gehäuse body
Kopf/head: ø 90 mm Baldachin: ø 65 mm G 8 Watt, ~2.700k, ~920 lm	Kopf/head: ø 130 mm Baldachin: ø 65 mm G 12 Watt, ~2.700k, ~1.300 lm	Kopf/head: ø 210 mm Baldachin: ø 80 mm G 16 Watt, ~2.700k, ~1.600 lm	
● 7-3279011 ● 7-3279012 ● 7-3279013 ● 7-3279012-22 ● 7-3279012-02 ● 7-3279012-23	● 7-32713011 ● 7-32713012 ● 7-32713013 ● 7-32713012-22 ● 7-32713012-02 ● 7-32713012-23	● 7-32721011 ● 7-32721012 ● 7-32721013 ● 7-32721012-22 ● 7-32721012-02 ● 7-32721012-23	chrome matt chrome nickel matt white matt/chrome black matt/chrome anthracite matt/chr.

Sun Swing – Down Light

Down Light LED	Down Light LED	Down Light LED	Gehäuse body
Kopf/head: ø 90 mm Baldachin: ø 65 mm G 8 Watt, ~2.700k, ~920 lm	Kopf/head: ø 130 mm Baldachin: ø 65 mm G 12 Watt, ~2.700k, ~1.300 lm	Kopf/head: ø 210 mm Baldachin: ø 80 mm G 16 Watt, ~2.700k, ~1.600 lm	
● 7-3289011 ● 7-3289012 ● 7-3289013 ● 7-3289012-22 ● 7-3289012-02 ● 7-3289012-23	● 7-32813011 ● 7-32813012 ● 7-32813013 ● 7-32813012-22 ● 7-32813012-02 ● 7-32813012-23	● 7-32821011 ● 7-32821012 ● 7-32821013 ● 7-32821012-22 ● 7-32821012-02 ● 7-32821012-23	chrome matt chrome nickel matt white matt/chrome black matt/chrome anthracite matt/chr.

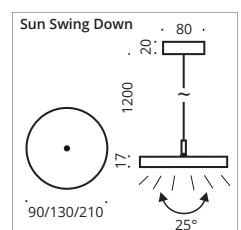
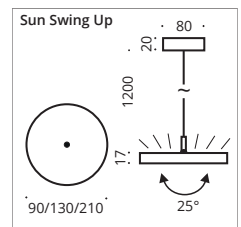
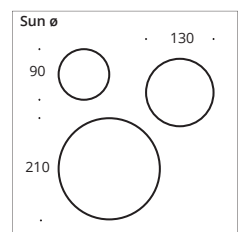





Sun Swing Choice ø 90/130/210

Lichtbalken für Direktmontage an der Decke. Bestückt mit LED Sun Leuchten, Kopfdurchmesser 90, 130 oder 210 mm. Pendellänge ca. 1.300 mm, Standard-Textilkabel in anthrazit.

Light bar for direct mounting on the ceiling. Equipped with LED Sun luminaires, head diameter ø 90, 130 or 210 mm. Pendant length approx. 1300 mm, with textile cable in anthracite as standard.

INDOOR

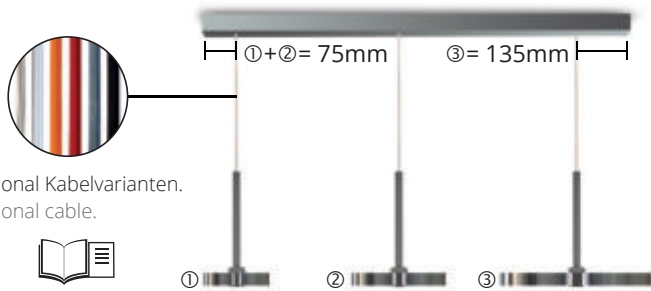
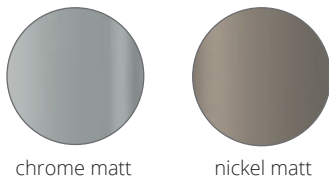

Sun ø 90 mm LED downlight

450 mm L 2 Köpfe/heads G 16W ~1.840lm ~2.700k	850 mm L 3 Köpfe/heads G 24W ~2.760lm ~2.700k	1.050 mm L 4 Köpfe/heads G 32W ~3.680lm ~2.700k	1.250 mm L 4 Köpfe/heads G 32W ~3.680lm ~2.700k	Gehäuse body
8-71904021	8-71908031	8-719010041	8-719012041	chrome matt
8-71904022	8-71908032	8-719010042	8-719012042	chrome
8-71904023	8-71908033	8-719010043	8-719012043	nickel matt
8-71904022-22	8-71908032-22	8-719010042-22	8-719012042-22	white matt/chr.
8-71904022-02	8-71908032-02	8-719010042-02	8-719012042-02	black matt/chr.
8-71904022-23	8-71908032-23	8-719010042-23	8-719012042-23	anthracite matt/chr.

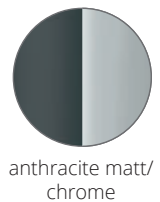
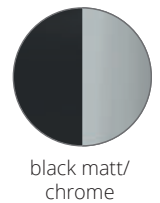
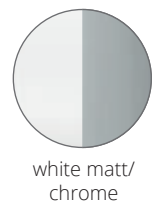

Farbig gepulverter Lichtbalken auf Anfrage. Color powdered metal rail on request.

Sun ø 130 mm LED downlight

450 mm L 2 Köpfe/heads G 24W ~2.600lm ~2.700k	650 mm L 3 Köpfe/heads G 36W ~3.900lm ~2.700k	1.050 mm L 4 Köpfe/heads G 48W ~5.200lm ~2.700k	1.250 mm L 4 Köpfe/heads G 48W ~5.200lm ~2.700k	Gehäuse body
8-711304021	8-711306031	8-7113010041	8-7113012041	chrome matt
8-711304022	8-711306032	8-7113010042	8-7113012042	chrome
8-711304023	8-711306033	8-7113010043	8-7113012043	nickel matt
8-711304022-22	8-711306032-22	8-7113010042-22	8-7113012042-22	white matt/chr.
8-711304022-02	8-711306032-02	8-7113010042-02	8-7113012042-02	black matt/chr.
8-711304022-23	8-711306032-23	8-7113010042-23	8-7113012042-23	anthracite matt/chr.

Farbig gepulverter Lichtbalken auf Anfrage. Color powdered metal rail on request.

Sun ø 210 mm LED downlight

850 mm L 2 Köpfe/heads G 32W ~3.200lm ~2.700k	1.050 mm L 3 Köpfe/heads G 48W ~4.800lm ~2.700k	1.250 mm L 3 Köpfe/heads G 48W ~4.800lm ~2.700k	Gehäuse body
8-712108031	8-7121010041	8-7121012041	chrome matt
8-712108032	8-7121010042	8-7121012042	chrome
8-712108033	8-7121010043	8-7121012043	nickel matt
8-712108032-22	8-7121010042-22	8-7121012042-22	white matt/chr.
8-712108032-02	8-7121010042-02	8-7121012042-02	black matt/chr.
8-712108032-23	8-7121010042-23	8-7121012042-23	anthracite matt/chr.

Farbig gepulverter Lichtbalken auf Anfrage. Color powdered metal rail on request.

Sonderanfertigung:

Art-Nr. 8-600 Kürzung auf Maß
Item No. 8-600 Customized lengths

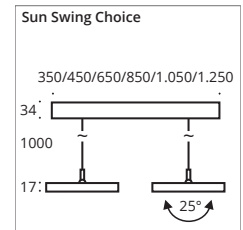
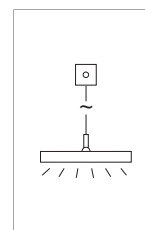
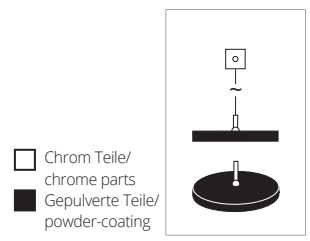





Foxx Swing ø 200/300/400/500

Mit 20 mm ist die Foxx Swing eine sensationell flache LED Pendelleuchte in den Durchmessern 200/300/400/500 mm. Mit Magnethalterungstechnik und der eingesetzten LED Hochvolttechnik heißt es nur noch »plug and light«. Pendellänge ca. 1.300 mm, Standard-Textilkabel in anthrazit.

With only 20 mm, the Foxx Swing is a sensationally slim LED pendant luminaire in the diameters of 200/300/400/500mm. With the high-voltage LED and magnetic mounting technology used, it is just a matter of »plug & light«. Pendant length approx. 1300 mm, with textile cable in anthracite as standard.

INDOOR

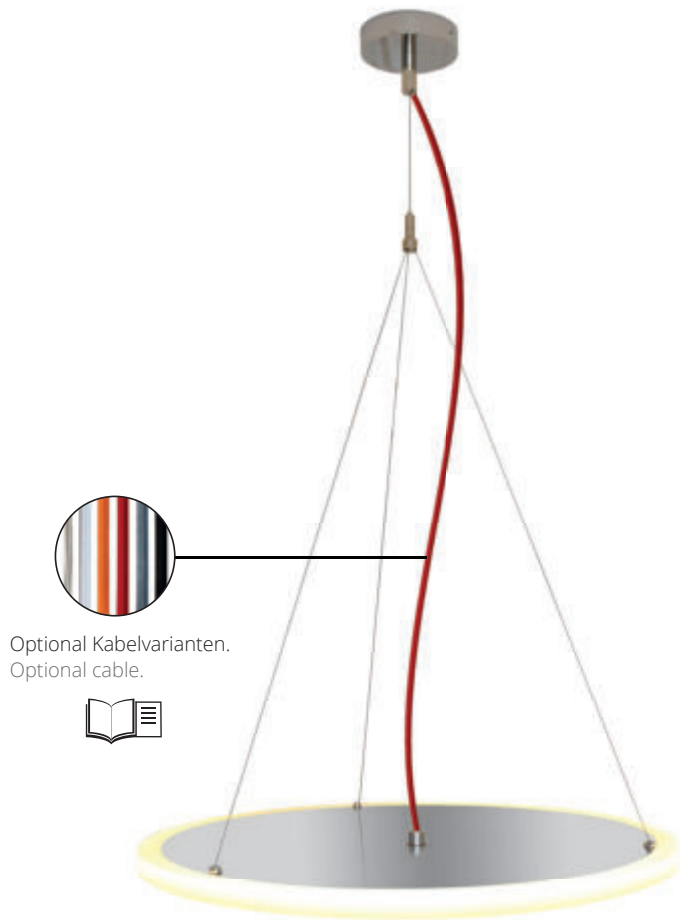

Foxx Swing 20/30/40/50 Pendelleuchte/pendant lamp LED

Swing 20 cm ø	Swing 30 cm ø	Swing 40 cm ø	Swing 50 cm ø	Gehäuse body
G	G	G	G	
10 Watt, ~2.700k ~700lm	14 Watt, ~2.700k ~1.260lm	22 Watt, ~2.700k ~1.980lm	33 Watt, ~2.700k ~2.970lm	
7-46620010	7-46630010	7-46640010	7-46650010	alueloxiert/ Acryl

Längere Aufhängung für hohe Decken bis 350 cm: Art-Nr. 7-466350
Extra long cable for high ceilings up to 350 cm: Item No. 7-466350

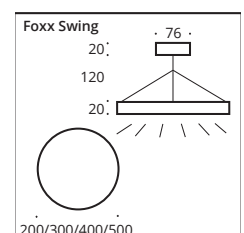

Pela
Quadro

Pela





Pela & Pela Quadro

Runde oder quadratische Pendelleuchte mit anthrazit Standard-Textilkabel und einer Länge von ca. 1.300 mm inklusive Glas und Baldachin. E27 Fassung.

Round or square pendant luminaire including glass and canopy. Pendant length approx. 1300 mm, with textile cable in anthracite as standard. E27 socket.

INDOOR

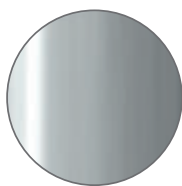

chrome



nickel matt



Richtungsweisend:
Aluminium-Hochleistungsreflektor, einfache Montage durch Einschub in den Glastubus.

Multi directional:
High performance baffle. Easy installation: slides into the tube.

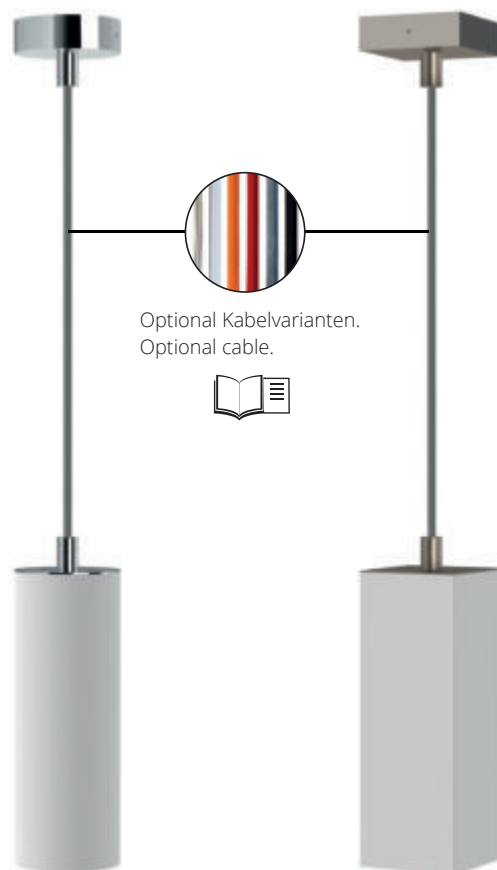

Optional Kabelvarianten.
Optional cable.

E27 Sockel	Art.Nr. item no.	Oberfläche surface
● Pela ● "Option"	5-07651	nickel matt
	5-07652	chrome
	9-200	Reflektor, baffle
● Pela Quadro ●	5-08651	nickel matt
	5-08652	chrome
Kabelverlängerung Cable extension	5-07951	auf Maß customized

E27 max. 42W, optional LED Retrofit
E27 max. 42W, LED Retrofit optional

Leuchtmittelempfehlung: LED max. 9W/800lm/2.700K **G** Art. Nr. 8-309
bulb recommendation: LED max. 9W/800Lm/2.700K **G** Item No. 8-309



Pela: ABC (s.S 6-7/s.p. 6-7)
Quadro: BC (s.S 6-7/s.p. 6-7)

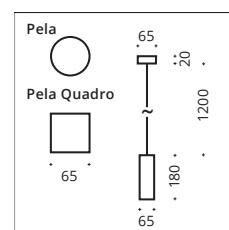





Pela Choice & Pela Quadro Choice

Lichtbalken für Direktmontage an der Decke. Bestückt mit Pela oder Pela Quadro Leuchten. Pendelleuchten aus der Top Light Serie. Pendellänge ca. 1.300 mm, Standard-Textilkabel in anthrazit.

Light bar for direct mounting on the ceiling. Equipped with Pela or Pela Quadro luminaires. Pendant luminaires of the Top Light series. Pendant length approx. 1300 mm, with textile cable in anthracite as standard.

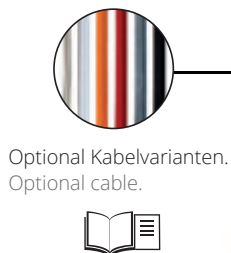
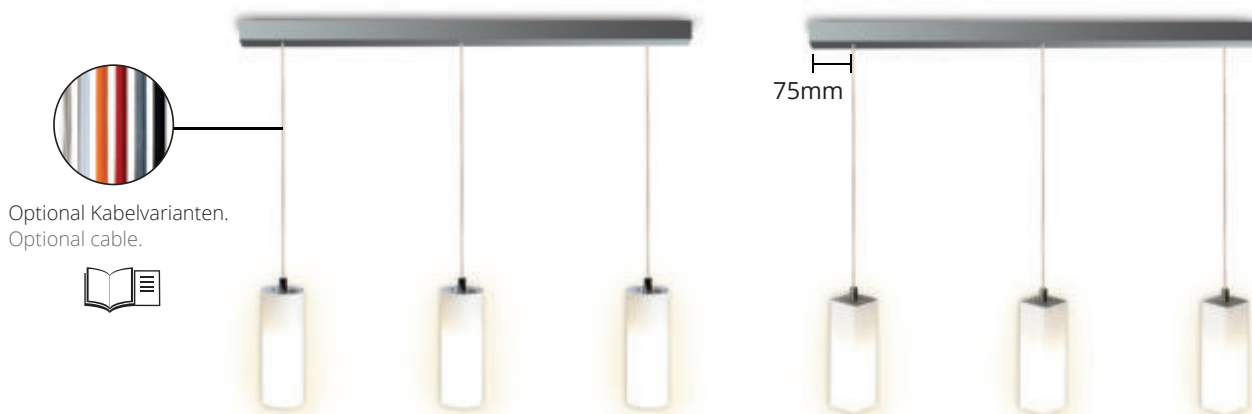

INDOOR

Pela

450 mm L	850 mm L	1.050 mm L	1.250 mm L	Gehäuse body
2 Köpfe/heads mit E27 Sockel E27 socket	3 Köpfe/heads mit E27 Sockel E27 socket	4 Köpfe/heads mit E27 Sockel E27 socket	4 Köpfe/heads mit E27 Sockel E27 socket	
8-764021	8-768031	8-7610041	8-7612041	nickel matt
8-764022	8-768032	8-7610042	8-7612042	chrome

Farbig gepulverter Lichtbalken auf Anfrage. Color powdered metal rail on request.

E27 max. 42W, optional LED Retrofit E27 max. 42W, LED Retrofit optional

LMempfehlung: LED max. 9W/800lm/2.700K **G** Art. Nr. 8-309

bulb recommend.: LED max. 9W/800Lm/2.700K **G** Item No. 8-309

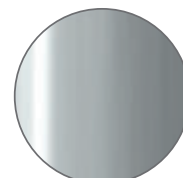

chrome

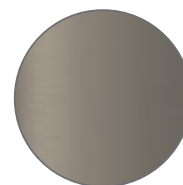

nickel matt

Pela Quadro

450 mm L	850 mm L	1.050 mm L	1.250 mm L	Gehäuse body
2 Köpfe/heads mit E27 Sockel E27 socket	3 Köpfe/heads mit E27 Sockel E27 socket	4 Köpfe/heads mit E27 Sockel E27 socket	4 Köpfe/heads mit E27 Sockel E27 socket	
8-774021	8-778031	8-7710041	8-7712041	nickel matt
8-774022	8-778032	8-7710042	8-7712042	chrome

Farbig gepulverter Lichtbalken auf Anfrage. Color powdered metal rail on request.

E27 max. 42W, optional LED Retrofit E27 max. 42W, LED Retrofit optional

LMempfehlung: LED max. 9W/800lm/2.700K **G** Art. Nr. 8-309

bulb recommend.: LED max. 9W/800Lm/2.700K **G** Item No. 8-309

Sonderanfertigung:

Art-Nr. 8-600 Kürzung auf Maß

Item No. 8-600 Customized lengths



C (S.S 6-7/s.p. 6-7)

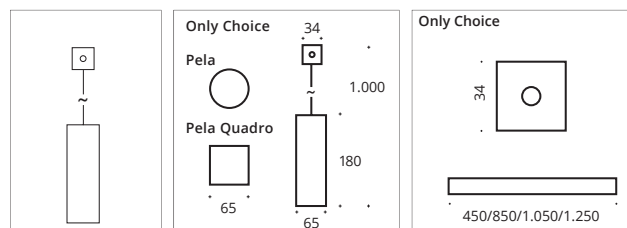



Look at me



Look at me

LED-Pendelleuchte mit 8 Watt und ~600 Lumen. Pendellänge ca. 1.300 mm, Standard-Textilkabel in anthrazit. EU Verordnung 874/2012, enthält eingebaute LED.

LED - pendant luminaire with 8 Watt and ~600 Lumen. Pendant length approx. 1300 mm, with textile cable in anthracite as standard. EU Regulation 874/2012, contains built-in LED.

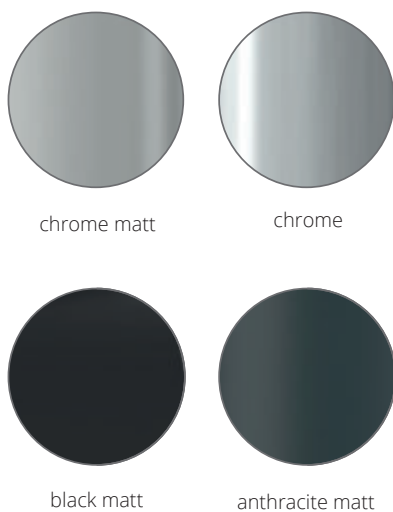

chrome matt

chrome

black matt

anthracite matt



Optional Kabelvarianten.
Optional cable.



white matt

INDOOR

Look at me Single

Single LED G 8W ~600lm ~2.700k	Single IP44 LED G 8W ~600lm ~2.700k	H x Ø H x Ø in mm	Gehäuse body
● 5-911-1	5-911-1-IP	215 x 85	chrommatt
● 5-911-2	5-911-2-IP	215 x 85	chrome
● 5-911-2-22	5-911-2-IP-22	215 x 85	white matt
● 5-911-2-02	5-911-2-IP-02	215 x 85	black matt
● 5-911-2-23	5-911-2-IP-23	215 x 85	anthracite matt

Look at me Trio

Trio LED G 8W ~1.800lm ~2.700k	Trio IP44 LED G 8W ~1.800lm ~2.700k	H x Ø H x Ø in mm	Gehäuse body
● 5-9113-1	5-9113-1-IP	215 x 85	chrommatt
● 5-9113-2	5-9113-2-IP	215 x 85	chrome
● 5-9113-2-22	5-9113-2-IP-22	215 x 85	white matt
● 5-9113-2-02	5-9113-2-IP-02	215 x 85	black matt
● 5-9113-2-23	5-9113-2-IP-23	215 x 85	anthracite matt

Art. Nr. item no.	Beschreibung description
2-9126	Lins klar, lens clear
2-9126-S	Linse einseitig mattiert lens satined on one side

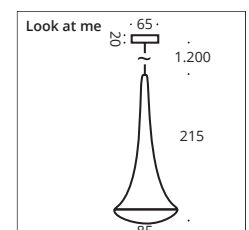

IP20: ABC (s.S 6-7/s.p. 6-7)
IP44: BC (s.S 6-7/s.p. 6-7)





Look at me Choice

Lichtbalken für direkte Montage an der Decke. Bestückt mit Look at me Leuchten. Pendelleuchten aus der Top Light Serie. Pendellänge ca. 1.300 mm, Standard-Textilkabel in anthrazit.

Light bar for direct mounting on the ceiling. Equipped with Look at me heads. Pendant luminaires of the Top Light series. Pendant length approx. 1300 mm, with textile cable in anthracite as standard.

INDOOR

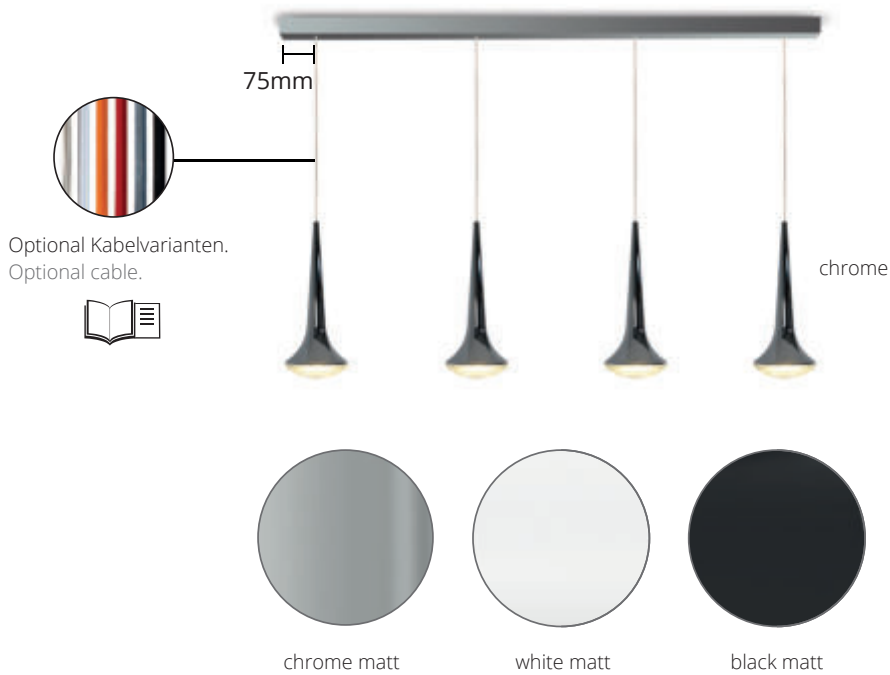

Look at me LED

450 mm L 2 Köpfe/heads G 16W ~1.200lm ~2.700k	850 mm L 3 Köpfe/heads G 24W ~1.800lm ~2.700k	1.050 mm L 4 Köpfe/heads G 32W ~2.400lm ~2.700k	1.250 mm L 4 Köpfe/heads G 32W ~2.400lm ~2.700k	Gehäuse body
8-794021	8-798031	8-7910041	8-7912041	chrome matt
8-794022	8-798032	8-7910042	8-7912042	chrome
8-794022-22	8-798032-22	8-7910042-22	8-7912042-22	white matt
8-794022-02	8-798032-02	8-7910042-02	8-7912042-02	black matt

Farbig gepulverter Lichtbalken = Preis auf Anfrage. Color powdered metal rail

Sonderanfertigung:

Art-Nr. 8-600 Kürzung auf Maß

Item No. 8-600 Customized lengths



C (s.S 6-7/s.p. 6-7)

□ Chrom Teile/
chrome parts
■ Gepulverte Teile/
powder-coating

Equipment

Art. Nr. item no.	Einsatz insert	Beschreibung description
2-9126 2-9126-S	Linse lens	klar, clear einseitig mattiert, satinated on one side

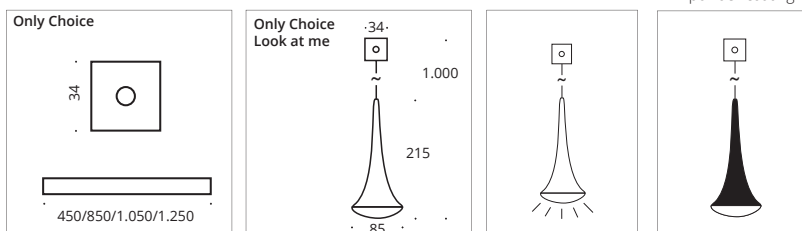



Puk Mini Floor Mini Twin

STEHLEUCHTEN

FLOOR LAMPS



Puk Mini Eye Floor 241
Puk Maxx Eye Floor 243
Puk Meg Maxx Eye Floor 245



Puk Mini Floor Mini 247
Puk Maxx Floor Mini 249



Puk Mini Floor Sister 251
Puk Maxx Floor Sister 253

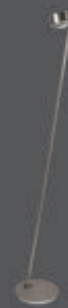

Puk Mini Floor Maxi 255
Puk Maxx Floor Maxi 257



Puk Mini Floor Mother-Kid 259
Puk Maxx Floor Mother-Kid 261



Sun Floor 263/265



Puk Mini Eye Floor



Puk Mini Eye Floor \varnothing 80

Stand- und Leseleuchte, G9 Fassung (mit Schalter, Dimmer optional) oder LED Niedervolt mit Tast-Dimmer. Fest verbaute untere Linse. Die Standardausstattung ist mit schwarzem Textilkabel.

Floor and reading lamp, G9 socket (with switch, dimmer optional) or LED low voltage with touch dimmer. Fixed lower lens. Supplied as standard with black textile cable.

INDOOR

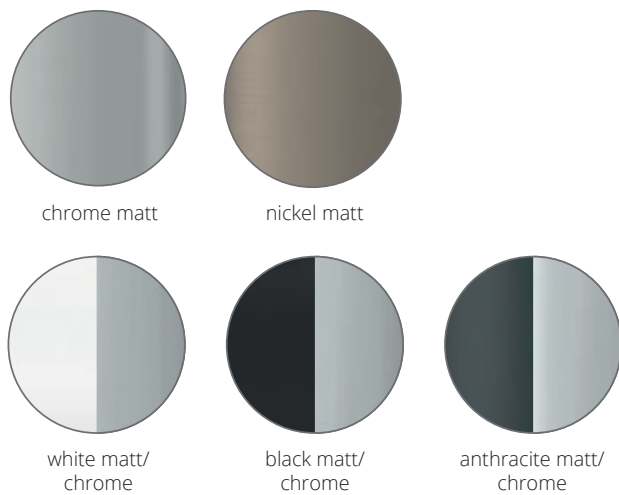

Puk Mini Eye G9 Fassung	Puk Mini Eye NV LED	Höhe height in mm	Gehäuse body
ON/OFF	20W ~2x900lm ~2.700k		
6-0813201-G9	6-0813201-NV-LED	1320	chrome matt
6-0813202-G9	6-0813202-NV-LED	1320	chrome
6-0813203-G9	6-0813203-NV-LED	1320	nickel matt
6-0813202-22-G9	6-0813202-NV-LED-22	1320	white matt/chrome
6-0813202-02-G9	6-0813202-NV-LED-02	1320	black matt/chrome
6-0813202-23-G9	6-0813202-NV-LED-23	1320	anthracite matt/chr.

Für Schnur-Dimmer bei G9 Leuchte »-D« an die Art.-Nr. hängen (Hochvolt)
Attach »-D« behind the item no. for a G9 cable dimmer (high voltage)

Die LED Niedervolt Leuchten sind standardmäßig mit Tast-Dimmer ausgestattet
The LED low voltage luminaires are standard equipped with touch dimmer

▶ Ohne Zubehör. Bestell-Artikelnummern für Linse, Glas, Farbfilter und die Konfigurationsempfehlung auf der Einklappseite!



▶ Without accessories: Order item-no. for lens, glass, color filter and the recommended Configuration are on the fold-in page!

Leuchtmittelangabe: LED Retrofit **G inkl.** ~3Watt ~300lm ~2.700K | G9 max. 33W ECO lamp information: LED Retrofit **G incl.** ~3Watt ~300lm ~2.700K | G9 max. 33W ECO

Leuchtmittellempfehlung: LED max. 3W/300lm/2.700K/dimmbar **G** Art. Nr. 8-205 bulb recommendation: LED max. 3W/300Lm/2.700K/dimmable **G** Item No. 8-205

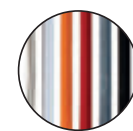

Optional Kabelvarianten.
Optional cable.



Eye Konfiguration (Empfehlung)
Eye Configuration (recommendation)

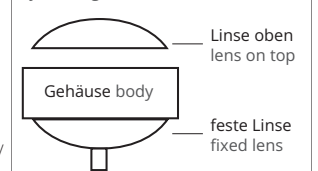

Chrom Teile/
chrome parts

Gepulverte Teile/
powder-coating

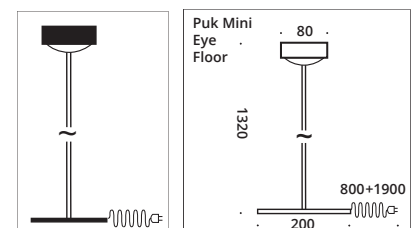



Puk Maxx Eye Floor



Puk Maxx Eye Floor \varnothing 120

Stand- und Leseleuchte, G9 Fassung (mit Schalter, Dimmer optional) oder LED Niedervolt mit Tast-Dimmer. Fest verbaute untere Linse. Die Standardausstattung ist mit schwarzem Textilkabel.

Floor and reading lamp, G9 socket (with switch, dimmer optional) or LED low voltage with touch dimmer. Fixed lower lens. Supplied as standard with black textile cable.

INDOOR

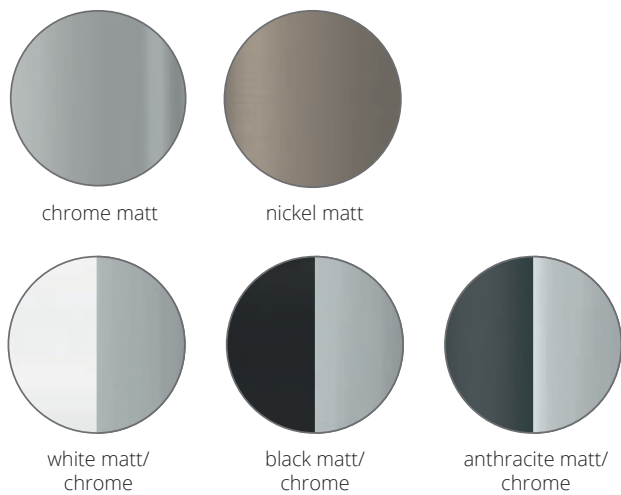

Puk Maxx Eye G9 Fassung ON/OFF	Puk Maxx Eye NV LED 20W ~2x900lm ~2.700k	Höhe height in mm	Gehäuse body
6-3813201-G9	6-3813201-NV-LED	1.320	chrome matt
6-3813202-G9	6-3813202-NV-LED	1.320	chrome
6-3813203-G9	6-3813203-NV-LED	1.320	nickel matt
6-3813202-22-G9	6-3813202-NV-LED-22	1.320	white matt/chrome
6-3813202-02-G9	6-3813202-NV-LED-02	1.320	black matt/chrome
6-3813202-23-G9	6-3813202-NV-LED-23	1.320	anthracite matt/chr.

Für Schnur-Dimmer bei G9 Leuchte »-D« an die Art.-Nr. hängen (Hochvolt)
Attach »-D« behind the item no. for a G9 cable dimmer (high voltage)

Die LED Niedervolt Leuchten sind standardmäßig mit Tast-Dimmer ausgestattet
The LED low voltage luminaires are standard equipped with touch dimmer

- ▶ Ohne Zubehör. Bestell-Artikelnummern für Linse, Glas, Farbfilter und die Konfigurationsempfehlung auf der Einklappseite!
- ▶ Without accessories: Order item-no. for lens, glass, color filter and the recommended Configuration are on the fold-in page!



Leuchtmittelangabe: LED Retrofit **G inkl.** ~3Watt ~300lm ~2.700K | G9 max. 33W ECO
lamp information: LED Retrofit **G incl.** ~3Watt ~300lm ~2.700K | G9 max. 33W ECO

Leuchtmittlempfehlung: LED max. 3W/300lm/2.700K/dimmbar **G** Art. Nr. 8-205
bulb recommendation: LED max. 3W/300Lm/2.700K/dimmable **G** Item No. 8-205

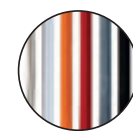

Optional Kabelvarianten.
Optional cable.



Eye Konfiguration (Empfehlung)
Eye Configuration (recommendation)

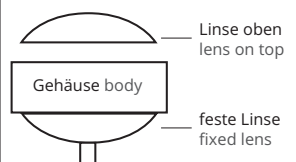

- Chrom Teile/
chrome parts
- Gepulverte Teile/
powder-coating

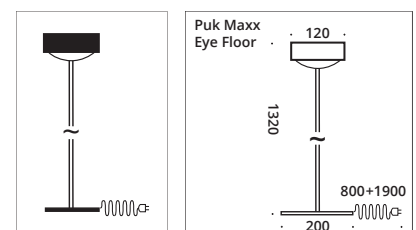



Puk Meg Maxx Eye Floor



Puk Meg Maxx Eye Floor ø 160

Stand- und Leseleuchte, G9 Fassung (mit Schalter, Dimmer optional) oder LED Niedervolt mit Tast-Dimmer. Fest verbaute untere Linse. Die Standardausstattung ist mit schwarzem Textilkabel.

Floor and reading lamp, G9 socket (with switch, dimmer optional) or LED low voltage with touch dimmer. Fixed lower lens. Supplied as standard with black textile cable.

INDOOR

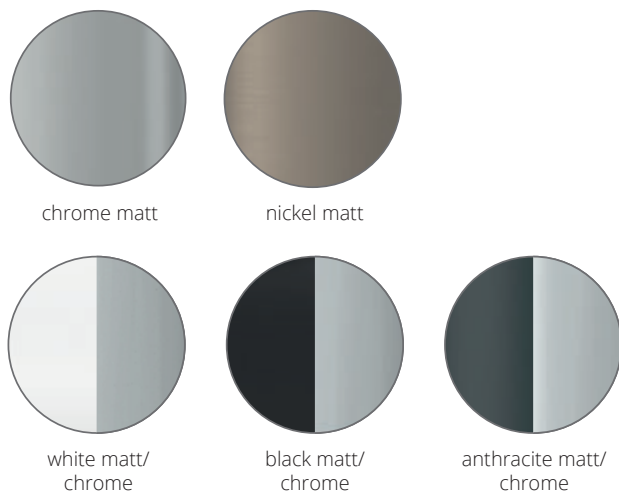

Puk Meg Maxx Eye G9 Fassung ON/OFF	Puk Meg Maxx Eye NV LED 20W ~2x900lm ~2.700k	Höhe height in mm	Gehäuse body
6-4013201-G9	6-4013201-NV-LED	1.320	chrome matt
6-4013202-G9	6-4013202-NV-LED	1.320	chrome
6-4013203-G9	6-4013203-NV-LED	1.320	nickel matt
6-4013202-22-G9	6-4013202-NV-LED-22	1.320	white matt/chrome
6-4013202-02-G9	6-4013202-NV-LED-02	1.320	black matt/chrome
6-4013202-23-G9	6-4013202-NV-LED-23	1.320	anthracite matt/chr.

Für Schnur-Dimmer bei G9 Leuchte »-D« an die Art.-Nr. hängen (Hochvolt)
Attach »-D« behind the item no. for a G9 cable dimmer (high voltage)

Die LED Niedervolt Leuchten sind standardmäßig mit Tast-Dimmer ausgestattet
The LED low voltage luminaires are standard equipped with touch dimmer

- ▶ Ohne Zubehör. Bestell-Artikelnummern für Linse, Glas, Farbfilter und die Konfigurationsempfehlung auf der Einklappseite!
- ▶ Without accessories: Order item-no. for lens, glass, color filter and the recommended Configuration are on the fold-in page!



Leuchtmittelangabe: LED Retrofit **G inkl.** ~3Watt ~300lm ~2.700K | G9 max. 33W ECO
lamp information: LED Retrofit **G incl.** ~3Watt ~300lm ~2.700K | G9 max. 33W ECO

Leuchtmittlempfehlung: LED max. 3W/300lm/2.700K/dimmbar **G** Art. Nr. 8-205
bulb recommendation: LED max. 3W/300Lm/2.700K/dimmable **G** Item No. 8-205

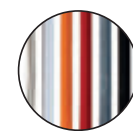

Optional Kabelvarianten.
Optional cable.



Eye Konfiguration (Empfehlung)
Eye Configuration (recommendation)

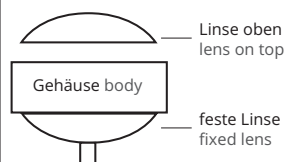

- Chrom Teile/
chrome parts
- Gepulverte Teile/
powder-coating

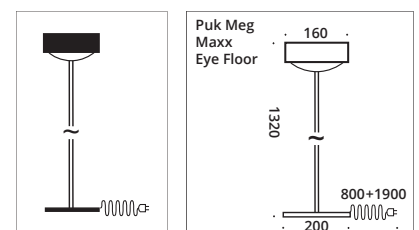



Puk Mini Floor Mini Single



Puk Mini Floor Mini ø 80

Stand- und Leseleuchte, G9 Fassung (mit Schalter, Dimmer optional) oder LED Niedervolt mit Tast-Dimmer, Kopf drehbar mit Verstellstift. Arm schwenkbar. Die Standardausstattung ist mit schwarzem Textilkabel.

Floor and reading lamp, G9 socket (with switch, dimmer optional) or LED low voltage with touch dimmer. Head rotatable with adjustment pin, arm pivotable. Supplied as standard with black textile cable.

INDOOR

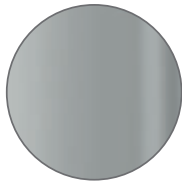

chrome matt

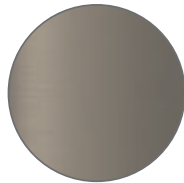

nickel matt

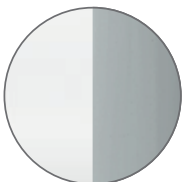

white matt/
chrome

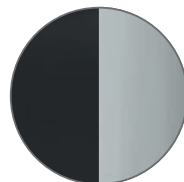

black matt/
chrome

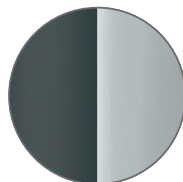

anthracite matt/
chrome



chrome

Puk Mini Floor Mini G9 Fassung ON/OFF	Puk Mini Floor Mini NV LED ~2.700k	Armlänge arm length in mm	Gehäuse body
Single	Single 20W ~2x900lm		
6-081201-1-G9	6-081201-1-NV-LED	1.250	chrome matt
6-081202-1-G9	6-081202-1-NV-LED	1.250	chrome
6-081203-1-G9	6-081203-1-NV-LED	1.250	nickel matt
6-081202-1-22-G9	6-081202-1-NV-LED-22	1.250	white matt/chr.
6-081202-1-02-G9	6-081202-1-NV-LED-02	1.250	black matt/chr.
6-081202-1-23-G9	6-081202-1-NV-LED-23	1.250	anthracite matt/chr.
Twin	Twin 20W ~4x600lm		
6-081201-2-G9	6-081201-2-NV-LED	1.250	chrome matt
6-081202-2-G9	6-081202-2-NV-LED	1.250	chrome
6-081203-2-G9	6-081203-2-NV-LED	1.250	nickel matt
6-081202-2-22-G9	6-081202-2-NV-LED-22	1.250	white matt/chr.
6-081202-2-02-G9	6-081202-2-NV-LED-02	1.250	black matt/chr.
6-081202-2-23-G9	6-081202-2-NV-LED-23	1.250	anthracite matt/chr.

Für Schnur-Dimmer bei G9 Leuchte »-D« an die Art.-Nr. hängen (Hochvolt)
Attach »-D« behind the item no. for a G9 cable dimmer (high voltage)

Die LED Niedervolt Leuchten sind standardmäßig mit Tast-Dimmer ausgestattet
The LED low voltage luminaires are standard equipped with touch dimmer

► Ohne Zubehör. Bestell-Artikelnummern für Linse, Glas, Farbfilter und die Konfigurationsempfehlung auf der Einklappseite!



► Without accessories: Order item-no. for lens, glass, color filter and the recommended Configuration are on the fold-in page!

Leuchtmittelangabe: LED Retrofit **G inkl.** ~3Watt ~300lm ~2.700K | G9 max. 33W ECO
lamp information: LED Retrofit **G incl.** ~3Watt ~300lm ~2.700K | G9 max. 33W ECO

Leuchtmittelempfehlung: LED max. 3W/300lm/2.700K/dimmbar **G** Art. Nr. 8-205
bulb recommendation: LED max. 3W/300Lm/2.700K/dimmable **G** Item No. 8-205

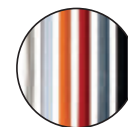

Optional Kabelvarianten.
Optional cable.



Chrom Teile/
chrome parts
 Gepulverte Teile/
powder-coating

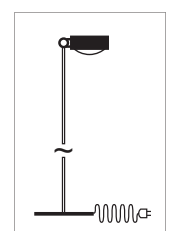
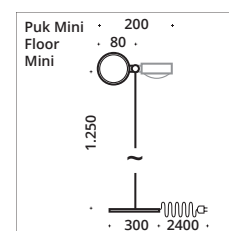



Puk Maxx Floor Mini



Puk Maxx Floor Mini ø 120

Stand- und Leseleuchte, G9 Fassung (mit Schalter, Dimmer optional) oder LED Niedervolt mit Tast-Dimmer, Kopf drehbar mit Verstellstift. Arm schwenkbar. Die Standardausstattung ist mit schwarzem Textilkabel.

Floor and reading lamp, G9 socket (with switch, dimmer optional) or LED low voltage with touch dimmer. Head rotatable with adjustment pin, arm pivotable. Supplied as standard with black textile cable.

INDOOR

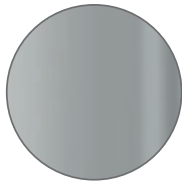

chrome matt

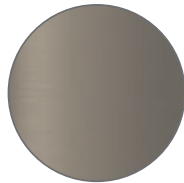

nickel matt

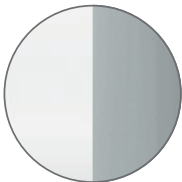

white matt/
chrome

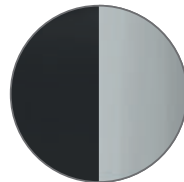

black matt/
chrome

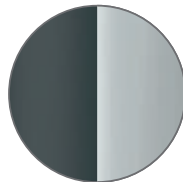

anthracite matt/
chrome



chrome

Puk Maxx Floor Mini G9 Fassung ON/OFF	Puk Maxx Floor Mini NV LED	Armlänge arm length in mm	Gehäuse body
6-381201-G9	6-381201-NV-LED	1.250	chrome matt
6-381202-G9	6-381202-NV-LED	1.250	chrome
6-381203-G9	6-381203-NV-LED	1.250	nickel matt
6-381202-22-G9	6-381202-NV-LED-22	1.250	white matt/chr.
6-381202-02-G9	6-381202-NV-LED-02	1.250	black matt/chr.
6-381202-23-G9	6-381202-NV-LED-23	1.250	anthracite matt/chr.

Für Schnur-Dimmer bei G9 Leuchte »-D« an die Art.-Nr. hängen (Hochvolt)
Attach »-D« behind the item no. for a G9 cable dimmer (high voltage)

Die LED Niedervolt Leuchten sind standardmäßig mit Tast-Dimmer ausgestattet
The LED low voltage luminaires are standard equipped with touch dimmer

▶ Ohne Zubehör. Bestell-Artikelnummern für Linse, Glas, Farbfilter und die Konfigurationsempfehlung auf der Einklappseite!

▶ Without accessories: Order item-no. for lens, glass, color filter and the recommended Configuration are on the fold-in page!



Leuchtmittelangabe: LED Retrofit **G inkl.** ~3Watt ~300lm ~2.700K | G9 max. 33W ECO
lamp information: LED Retrofit **G incl.** ~3Watt ~300lm ~2.700K | G9 max. 33W ECO

Leuchtmittelempfehlung: LED max. 3W/300lm/2.700K/dimmbar **G** Art. Nr. 8-205
bulb recommendation: LED max. 3W/300Lm/2.700K/dimmable **G** Item No. 8-205



Optional Kabelvarianten.
Optional cable.



Chrom Teile/
chrome parts
 Gepulverte Teile/
powder-coating

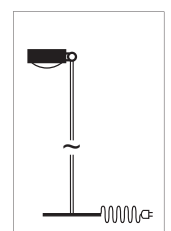
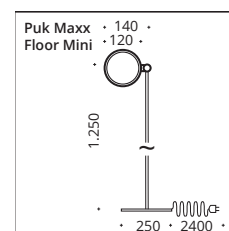





Puk Mini Floor Sister ø 80

Stand- und Leseleuchte, G9 Fassung (mit Schalter, Dimmer optional) oder LED Niedervolt mit Tast-Dimmer, Köpfe drehbar mit Verstellstift. Arme schwenkbar. Die Standardausstattung ist mit schwarzem Textilkabel.

Floor and reading lamp, G9 socket (with switch, dimmer optional) or LED low voltage with touch dimmer. Head rotatable with adjustment pin, arm pivotable. Supplied as standard with black textile cable.

INDOOR

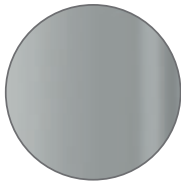

chrome matt

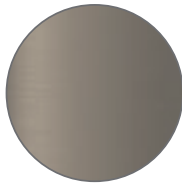

nickel matt

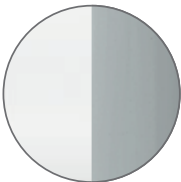

white matt/
chrome

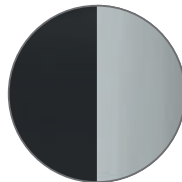

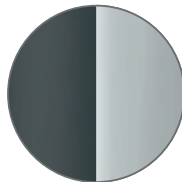

black matt/
chrome



anthracite matt/
chrome



chrome

Puk Mini Floor Sister G9 Fassung  ON/OFF	Puk Mini Floor Sister NV LED  2x20W ~4x900lm ~2.700k	Armlänge arm length in mm	Gehäuse body
6-0821201-G9	6-0821201-NV-LED	2 x 1.250	chrome matt
6-0821202-G9	6-0821202-NV-LED	2 x 1.250	chrome
6-0821203-G9	6-0821203-NV-LED	2 x 1.250	nickel matt
6-0821202-22-G9	6-0821202-NV-LED-22	2 x 1.250	white matt/chr.
6-0821202-02-G9	6-0821202-NV-LED-02	2 x 1.250	black matt/chr.
6-0821202-23-G9	6-0821202-NV-LED-23	2 x 1.250	anthracite matt /chr.

Für Schnur-Dimmer bei G9 Leuchte »-D« an die Art.-Nr. hängen (Hochvolt)
Attach »-D« behind the item no. for a G9 cable dimmer (high voltage)

Die LED Niedervolt Leuchten sind standardmäßig mit Tast-Dimmer ausgestattet
The LED low voltage luminaires are standard equipped with touch dimmer



► Ohne Zubehör. Bestell-Artikelnummern für Linse, Glas, Farbfilter und die Konfigurationsempfehlung auf der Einklappseite!



► Without accessories: Order item-no. for lens, glass, color filter and the recommended Configuration are on the fold-in page!

 Leuchtmittelangabe: LED Retrofit **G inkl.** ~3Watt ~300lm ~2.700K | G9 max. 33W ECO
lamp information: LED Retrofit **G incl.** ~3Watt ~300lm ~2.700K | G9 max. 33W ECO

 Leuchtmittelempfehlung: LED max. 3W/300lm/2.700K/dimmbar **G** Art. Nr. 8-205
bulb recommendation: LED max. 3W/300Lm/2.700K/dimmable **G** Item No. 8-205

 Chrom Teile/
chrome parts
 Gepulverte Teile/
powder-coating

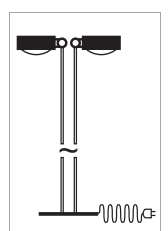
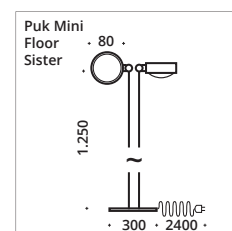

     C (s.S 6-7/s.p. 6-7)





Puk Maxx Floor Sister ø 120

Stand- und Leseleuchte, G9 Fassung (mit Schalter, Dimmer optional) oder LED Niedervolt mit Tast-Dimmer, Köpfe drehbar mit Verstellstift. Arme schwenkbar. Die Standardausstattung ist mit schwarzem Textilkabel.

Floor and reading lamp, G9 socket (with switch, dimmer optional) or LED low voltage with touch dimmer. Head rotatable with adjustment pin, arm pivotable. Supplied as standard with black textile cable.

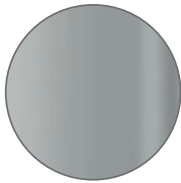

chrome matt

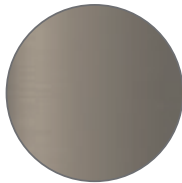

nickel matt

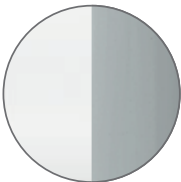

white matt/
chrome

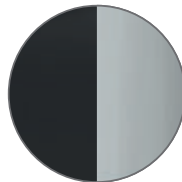



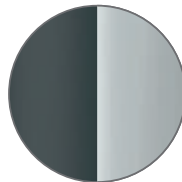





black matt/
chrome



anthracite matt/
chrome



chrome

Puk Maxx Floor Sister G9 Fassung  ON/OFF	Puk Maxx Floor Sister NV LED  2x20W ~4x900lm ~2.700k	Armlänge arm length in mm	Gehäuse body
 6-3821201-G9	6-3821201-NV-LED	2 x 1.250	chrome matt
 6-3821202-G9	6-3821202-NV-LED	2 x 1.250	chrome
 6-3821203-G9	6-3821203-NV-LED	2 x 1.250	nickel matt
 6-3821202-22-G9	6-3821202-NV-LED-22	2 x 1.250	white matt/chr.
 6-3821202-02-G9	6-3821202-NV-LED-02	2 x 1.250	black matt/chr.
 6-3821202-23-G9	6-3821202-NV-LED-23	2 x 1.250	anthracite matt/chr.

Für Schnur-Dimmer bei G9 Leuchte »-D« an die Art.-Nr. hängen (Hochvolt)
Attach »-D« behind the item no. for a G9 cable dimmer (high voltage)



Die LED Niedervolt Leuchten sind standardmäßig mit Tast-Dimmer ausgestattet
The LED low voltage luminaires are standard equipped with touch dimmer

- ▶ Ohne Zubehör. Bestell-Artikelnummern für Linse, Glas, Farbfilter und die Konfigurationsempfehlung auf der Einklappseite!
- ▶ Without accessories: Order item-no. for lens, glass, color filter and the recommended Configuration are on the fold-in page!



 Leuchtmittelangabe: LED Retrofit **G inkl.** ~3Watt ~300lm ~2.700K | G9 max. 33W ECO
lamp information: LED Retrofit **G incl.** ~3Watt ~300lm ~2.700K | G9 max. 33W ECO

 Leuchtmittlempfehlung: LED max. 3W/300lm/2.700K/dimmbar  Art. Nr. 8-205
bulb recommendation: LED max. 3W/300Lm/2.700K/dimmable  Item No. 8-205

-  Chrom Teile/
chrome parts
-  Gepulverte Teile/
powder-coating

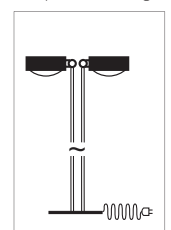
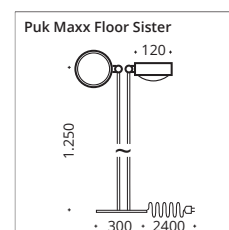

C (s.S 6-7/s.p. 6-7)





Puk Mini Floor Maxi Ø 80

Stand- und Leseleuchte, G9 Fassung (mit Schalter, Dimmer optional) oder LED Niedervolt mit Tast-Dimmer, Köpfe drehbar mit Verstellstift. Arm schwenkbar. Die Standardausstattung ist mit schwarzem Textilkabel.

Floor and reading lamp, G9 socket (with switch, dimmer optional) or LED low voltage with touch dimmer. Head rotatable with adjustment pin, arm pivotable. Supplied as standard with black textile cable.

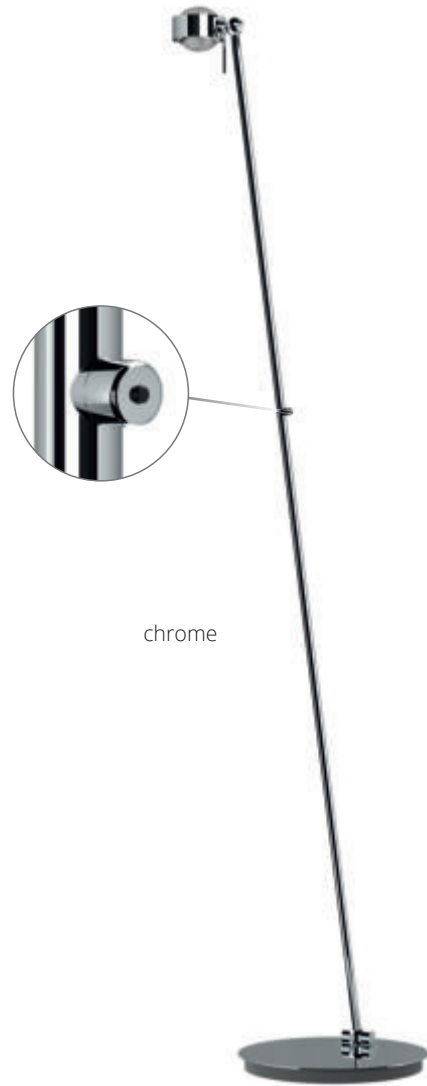
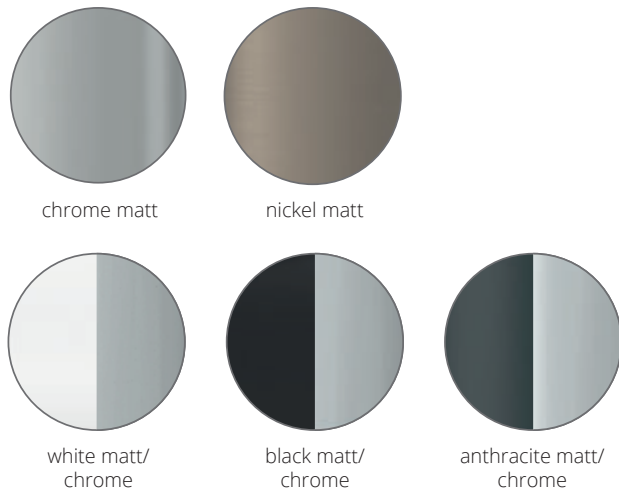

INDOOR

Puk Mini Floor Maxi G9 Fassung ON/OFF	Puk Mini Floor Maxi NV LED ~2.700k	Armlänge arm length in mm	Gehäuse body
Single	Single 20W ~2x900lm		
6-081801-1-G9	6-081801-1-NV-LED	1.800	chrome matt
6-081802-1-G9	6-081802-1-NV-LED	1.800	chrome
6-081803-1-G9	6-081803-1-NV-LED	1.800	nickel matt
6-081802-1-22-G9	6-081802-1-NV-LED-22	1.800	white matt/chr.
6-081802-1-02-G9	6-081802-1-NV-LED-02	1.800	black matt/chr.
6-081802-1-23-G9	6-081802-1-NV-LED-23	1.800	anthracite matt/chr.
Twin	Twin 20W ~4x600lm		
6-081801-2-G9	6-081801-2-NV-LED	1.800	chrome matt
6-081802-2-G9	6-081802-2-NV-LED	1.800	chrome
6-081803-2-G9	6-081803-2-NV-LED	1.800	nickel matt
6-081802-2-22-G9	6-081802-2-NV-LED-22	1.800	white matt/chr.
6-081802-2-02-G9	6-081802-2-NV-LED-02	1.800	black matt/chr.
6-081802-2-23-G9	6-081802-2-NV-LED-23	1.800	anthracite matt/chr.

Für Schnur-Dimmer bei G9 Leuchte »-D« an die Art.-Nr. hängen (Hochvolt)
Attach »-D« behind the item no. for a G9 cable dimmer (high voltage)

Die LED Niedervolt Leuchten sind standardmäßig mit Tast-Dimmer ausgestattet
The LED low voltage luminaires are standard equipped with touch dimmer

- ▶ Ohne Zubehör. Bestell-Artikelnummern für Linse, Glas, Farbfilter und die Konfigurationsempfehlung auf der Einklappseite!
- ▶ Without accessories: Order item-no. for lens, glass, color filter and the recommended Configuration are on the fold-in page!



Leuchtmittelangabe: LED Retrofit **G inkl.** ~3Watt ~300lm ~2.700K | G9 max. 33W ECO
lamp information: LED Retrofit **G incl.** ~3Watt ~300lm ~2.700K | G9 max. 33W ECO

Leuchtmittelempfehlung: LED max. 3W/300lm/2.700K/dimmbar **G** Art. Nr. 8-205
bulb recommendation: LED max. 3W/300lm/2.700K/dimmable **G** Item No. 8-205



Optional Kabelvarianten.
Optional cable.



- Chrom Teile/
chrome parts
- Gepulverte Teile/
powder-coating

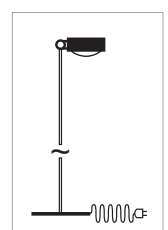
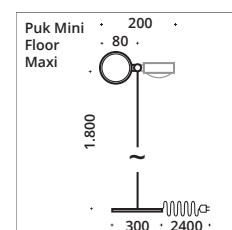





Puk Maxx Floor Maxi ø 120

Stand- und Leseleuchte, G9 Fassung (mit Schalter, Dimmer optional) oder LED Niedervolt mit Tast-Dimmer, Kopf drehbar mit Verstellstift. Arm schwenkbar. Die Standardausstattung ist mit schwarzem Textilkabel.

Floor and reading lamp, G9 socket (with switch, dimmer optional) or LED low voltage with touch dimmer. Head rotatable with adjustment pin, arm pivotable. Supplied as standard with black textile cable.

INDOOR

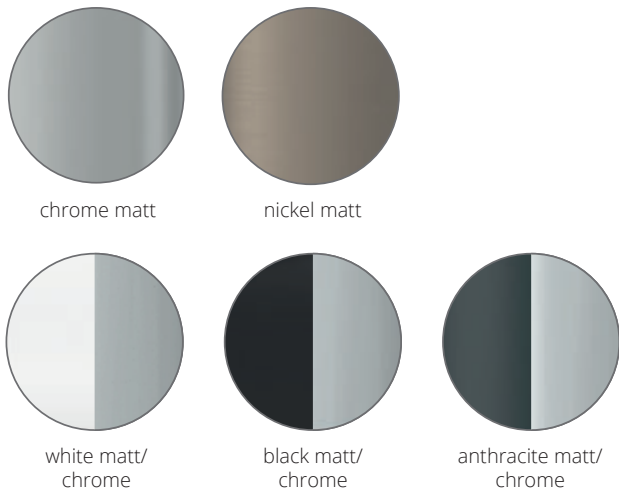

chrome

Puk Maxx Floor Maxi G9 Fassung ON/OFF	Puk Maxx Floor Maxi NV LED ~2.700k	Armlänge arm length in mm	Gehäuse body
Single	Single 20W ~2x900lm		
6-381801-G9	6-381801-NV-LED	1.800	chrome matt
6-381802-G9	6-381802-NV-LED	1.800	chrome
6-381803-G9	6-381803-NV-LED	1.800	nickel matt
6-381802-22-G9	6-381802-NV-LED-22	1.800	white matt/chr.
6-381802-02-G9	6-381802-NV-LED-02	1.800	black matt/chr.
6-381802-23-G9	6-381802-NV-LED-23	1.800	anthracite matt/chr.
Twin	Twin 20W ~4x600lm		
6-3818021-G9	6-3818021-NV-LED	1.800	chrome matt
6-3818022-G9	6-3818022-NV-LED	1.800	chrome
6-3818023-G9	6-3818023-NV-LED	1.800	nickel matt
6-3818022-22-G9	6-3818022-NV-LED-22	1.800	white matt/chr.
6-3818022-02-G9	6-3818022-NV-LED-02	1.800	black matt/chr.
6-3818022-23-G9	6-3818022-NV-LED-23	1.800	anthracite matt/chr.

Für Schnur-Dimmer bei G9 Leuchte »-D« an die Art.-Nr. hängen (Hochvolt)
Attach »-D« behind the item no. for a G9 cable dimmer (high voltage)

Die LED Niedervolt Leuchten sind standardmäßig mit Tast-Dimmer ausgestattet
The LED low voltage luminaires are standard equipped with touch dimmer

- ▶ Ohne Zubehör. Bestell-Artikelnummern für Linse, Glas, Farbfilter und die Konfigurationsempfehlung auf der Einklappseite!
- ▶ Without accessories: Order item-no. for lens, glass, color filter and the recommended Configuration are on the fold-in page!



Leuchtmittelangabe: LED Retrofit **G inkl.** ~3Watt ~300lm ~2.700K | G9 max. 33W ECO
lamp information: LED Retrofit **G incl.** ~3Watt ~300lm ~2.700K | G9 max. 33W ECO

Leuchtmittelpfehlung: LED max. 3W/300lm/2.700K/dimmbar **G** Art. Nr. 8-205
bulb recommendation: LED max. 3W/300Lm/2.700K/dimmable **G** Item No. 8-205



Optional Kabelvarianten.
Optional cable.



- Chrom Teile/
chrome parts
- Gepulverte Teile/
powder-coating

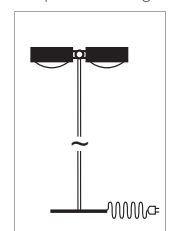
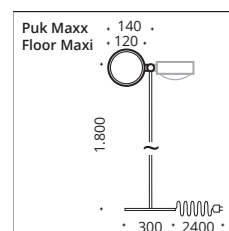





Puk Mini Floor Mother-Kid ø 80

Stand- und Leseleuchte, G9 Fassung (mit Schalter, Dimmer optional) oder LED Niedervolt mit Tast-Dimmer, Köpfe drehbar mit Verstellstift. Arme schwenkbar. Die Standardausstattung ist mit schwarzem Textilkabel.

Floor and reading lamp, G9 socket (with switch, dimmer optional) or LED low voltage with touch dimmer. Heads rotatable with adjustment pin, arm pivotable. Supplied as standard with black textile cable.

INDOOR

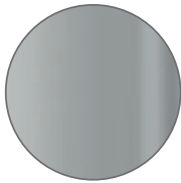

chrome matt

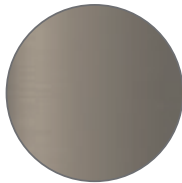

nickel matt

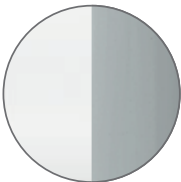

white matt/
chrome

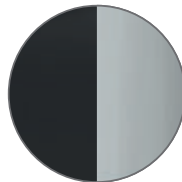

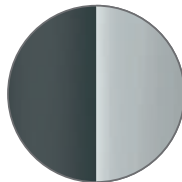

black matt/
chrome



anthracite
matt/chrome



Puk Mini Floor Mother-Kid G9 Fassung 	Puk Mini Floor Mother-Kid NV LED 	Armlänge arm length in mm	Gehäuse body
6-082180120-1-G9	6-082180120-1-NV-LED	1.800 + 1.250	chrome matt
6-082180120-2-G9	6-082180120-2-NV-LED	1.800 + 1.250	chrome
6-082180120-3-G9	6-082180120-3-NV-LED	1.800 + 1.250	nickel matt
6-082180120-2-22-G9	6-082180120-2-NV-LED-22	1.800 + 1.250	white matt/chr.
6-082180120-2-02-G9	6-082180120-2-NV-LED-02	1.800 + 1.250	black matt/chr.
6-082180120-2-23-G9	6-082180120-2-NV-LED-23	1.800 + 1.250	anthracite matt/chr.

Für Schnur-Dimmer bei G9 Leuchte »-D« an die Art.-Nr. hängen (Hochvolt)
Attach »-D« behind the item no. for a G9 cable dimmer (high voltage)

Die LED Niedervolt Leuchten sind standardmäßig mit Tast-Dimmer ausgestattet
The LED low voltage luminaires are standard equipped with touch dimmer

- ▶ Ohne Zubehör. Bestell-Artikelnummern für Linse, Glas, Farbfilter und die Konfigurationsempfehlung auf der Einklappseite!
- ▶ Without accessories: Order item-no. for lens, glass, color filter and the recommended Configuration are on the fold-in page!



 Leuchtmittelangabe: LED Retrofit **G inkl.** ~3Watt ~300lm ~2.700K | G9 max. 33W ECO
lamp information: LED Retrofit **G incl.** ~3Watt ~300lm ~2.700K | G9 max. 33W ECO

 Leuchtmittelempfehlung: LED max. 3W/300lm/2.700K/dimmbar **G** Art. Nr. 8-205
bulb recommendation: LED max. 3W/300lm/2.700K/dimmable **G** Item No. 8-205

- Chrom Teile/
chrome parts
- Gepulverte Teile/
powder-coating

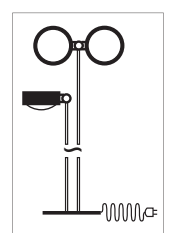
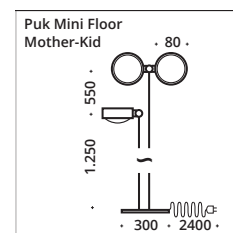

C (s.S 6-7/s.p. 6-7)



Puk Maxx Floor Mother-Kid



Puk Maxx Floor Mother-Kid ø 120

Stand- und Leseleuchte, G9 Fassung (mit Schalter, Dimmer optional) oder LED Niedervolt mit Tast-Dimmer, Köpfe drehbar mit Verstellstift. Arme schwenkbar. Die Standardausstattung ist mit schwarzem Textilkabel.

Floor and reading lamp, G9 socket (with switch, dimmer optional) or LED low voltage with touch dimmer. Heads rotatable with adjustment pin, arm pivotable. Supplied as standard with black textile cable.

INDOOR

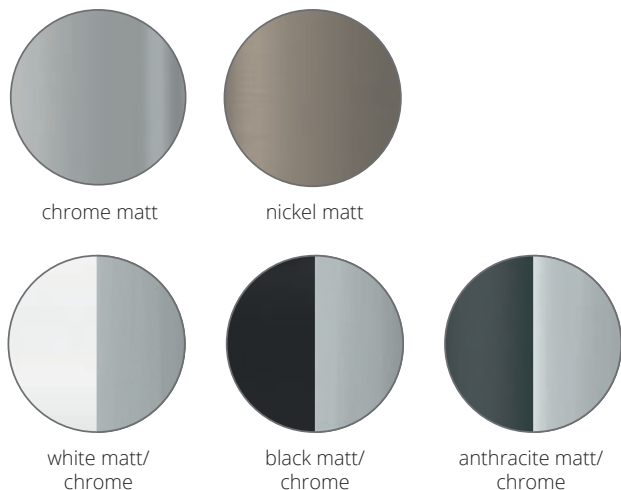

chrome

Puk Maxx Floor Mother-Kid G9 Fassung	Puk Maxx Floor Mother-Kid NV LED	Armlängen arm lengths in mm	Gehäuse body
ON/OFF	20W ~2x900lm 20W ~4x600lm ~2.700k		
6-3821801201-G9	6-3821801201-NV-LED	1.800 + 1.250	chrome matt
6-3821801202-G9	6-3821801202-NV-LED	1.800 + 1.250	chrome
6-3821801203-G9	6-3821801203-NV-LED	1.800 + 1.250	nickel matt
6-3821801202-22-G9	6-3821801202-NV-LED-22	1.800 + 1.250	white matt/chr.
6-3821801202-02-G9	6-3821801202-NV-LED-02	1.800 + 1.250	black matt/chr.
6-3821801202-23-G9	6-3821801202-NV-LED-23	1.800 + 1.250	anthracite matt/chr.

Für Schnurschiebe-Dimmer bei G9 Leuchte »-D« an die Art.-Nr. hängen (Hochvolt)
Attach »-D« behind the item no. for a G9 cable dimmer (high voltage)

Die LED Niedervolt Leuchten sind standardmäßig mit Tast-Dimmer ausgestattet
The LED low voltage luminaires are standard equipped with touch dimmer

- ▶ Ohne Zubehör. Bestell-Artikelnummern für Linse, Glas, Farbfilter und die Konfigurationsempfehlung auf der Einklappseite!
- ▶ Without accessories: Order item-no. for lens, glass, color filter and the recommended Configuration are on the fold-in page!



Leuchtmittelangabe: LED Retrofit **G inkl.** ~3Watt ~300lm ~2.700K | G9 max. 33W ECO
lamp information: LED Retrofit **G incl.** ~3Watt ~300lm ~2.700K | G9 max. 33W ECO

Leuchtmittlempfehlung: LED max. 3W/300lm/2.700K/dimmbar **G** Art. Nr. 8-205
bulb recommendation: LED max. 3W/300Lm/2.700K/dimmable **G** Item No. 8-205

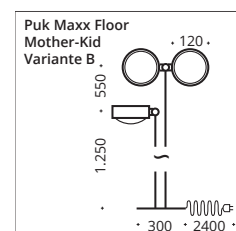
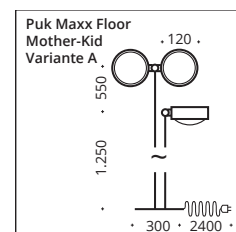

Chrom Teile/
chrome parts
 Gepulverte Teile/
powder-coating

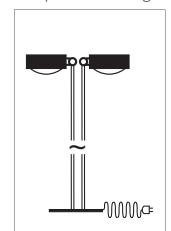





INDOOR

Sun Floor ø 90/130/210 Down Light

Der Leuchtenkopf der LED Stehleuchte Sun Floor, lässt sich in alle Richtungen über ein Kugelgelenk schwenken. Sie ist in den Durchmessern 90/130/210 mm erhältlich. Bei dieser Leseleuchte sind die Längen 1000 oder 1250 mm wählbar. Die Standardausstattung ist mit Schnurschalter und schwarzem Textilkabel. Optional kann die Leuchte mit Dimmring bestellt werden.

The luminaire head of the LED floor lamp Sun Floor can be swivelled in all directions via a ball joint. It is available in the diameters 90/130/210 mm. The lengths of 1000 and 1250 mm are available for this reading lamp. The standard version is with cord switch and black textile cable. Optionally, the luminaire can be ordered with a dimming ring.

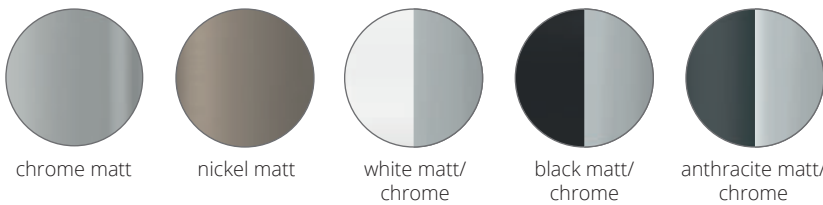

chrome matt nickel matt white matt/chrome black matt/chrome anthracite matt/chrome

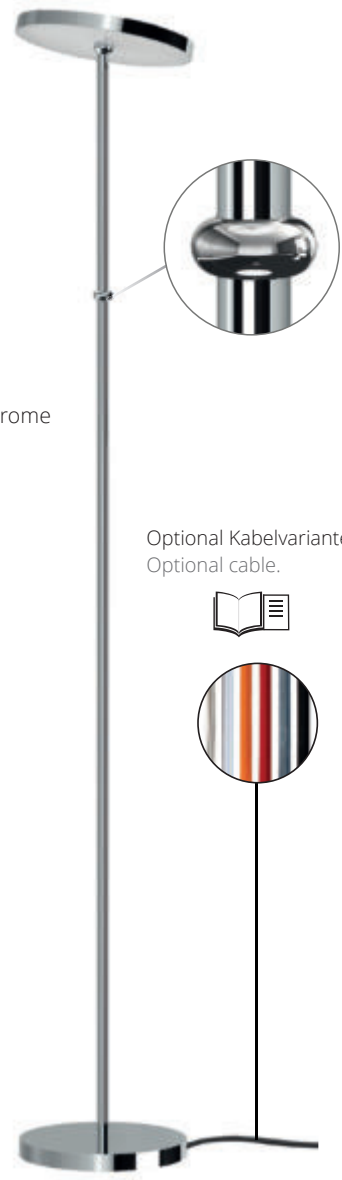

chrome

Optional Kabelvarianten.
Optional cable.



Sun Floor - Down Light LED

90 mm ø	130 mm ø	210 mm ø	Höhe height in mm	Gehäuse body
G 8 Watt, ~2.700k ~920 lm	G 12 Watt, ~2.700k ~1.300 lm	G 16 Watt, ~2.700k ~1.600 lm		
7-3329011	7-33213011	7-33221011	1.000	chrome matt
7-3329012	7-33213012	7-33221012	1.000	chrome
7-3329013	7-33213013	7-33221013	1.000	nickel matt
7-3329012-22	7-33213012-22	7-33221012-22	1.000	white matt/chrome
7-3329012-02	7-33213012-02	7-33221012-02	1.000	black matt/chrome
7-3329012-23	7-33213012-23	7-33221012-23	1.000	anthracite matt/chr.
Dimmring	Art.-Nr. item no.	-DR		chrome

Sun Floor - Down Light LED

90 mm ø	130 mm ø	210 mm ø	Höhe height in mm	Gehäuse body
G 8 Watt, ~2.700k ~920 lm	G 12 Watt, ~2.700k ~1.300 lm	G 16 Watt, ~2.700k ~1.600 lm		
7-3339011	7-33313011	7-33321011	1.250	chrome matt
7-3339012	7-33313012	7-33321012	1.250	chrome
7-3339013	7-33313013	7-33321013	1.250	nickel matt
7-3339012-22	7-33313012-22	7-33321012-22	1.250	white matt/chrome
7-3339012-02	7-33313012-02	7-33321012-02	1.250	black matt/chrome
7-3339012-23	7-33313012-23	7-33321012-23	1.250	anthracite matt/chr.
Dimmring	Art.-Nr. item no.	-DR		chrome

□ Chrom Teile/
chrome parts
■ Gepulverte Teile/
powder-coating

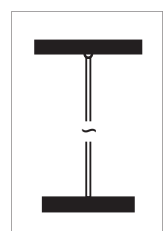
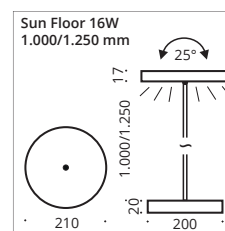
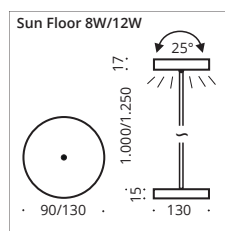
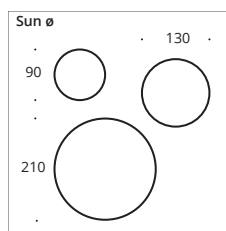

CE LED C IP20 C (s.S. 6-7/s.p. 6-7)



Sun Floor Uplight



Sun Floor \varnothing 90/130/210 Up or Down Light

Der Leuchtenkopf des LED Standfluters Sun Floor, lässt sich in alle Richtungen über ein Kugelgelenk schwenken. Diese Stehleuchte hat einen Leuchtenkopfdurchmesser von 210 mm und eine Länge von 1800 mm. Sie ist als Up- oder Downlight lieferbar. Die Standardausstattung ist mit Schnurschalter und schwarzem Textilkabel. Optional kann die Leuchte mit Dimmrig bestellt werden.

The luminaire head of the LED Sun Floor model can be swivelled in all directions via a ball joint. This floor lamp has a diameter of 210 mm and a length of 1800 mm. It is available as uplight or downlight. The standard version is with cord switch and black textile cable. Optionally, the luminaire can be ordered with a dimming ring.

INDOOR

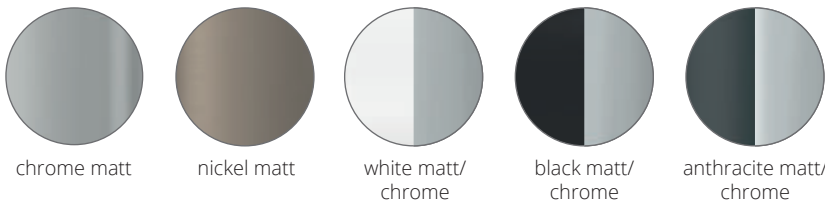

chrome matt

nickel matt

white matt/
chrome

black matt/
chrome

anthracite matt/
chrome

Optional Kabelvarianten.
Optional cable.

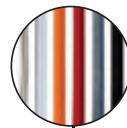

Sun Floor – Up or Down Light LED

Up Light
210 mm \varnothing

G
16 Watt, ~2.700k
~1.600 lm

Down Light
210 mm \varnothing

G
16 Watt, ~2.700k
~1.600 lm

Höhe
height
in mm

Gehäuse
body

● 7-33421011	7-33521011	1.800	chrome matt
● 7-33421012	7-33521012	1.800	chrome
● 7-33421013	7-33521013	1.800	nickel matt
● 7-33421012-22	7-33521012-22	1.800	white matt/chrome
● 7-33421012-02	7-33521012-02	1.800	black matt/chrome
● 7-33421012-23	7-33521012-23	1.800	anthracite matt/chr.

Dimmring Art.-Nr. item no. -DR

chrome



C (s.S 6-7/s.p. 6-7)



□ Chrom Teile/
chrome parts
■ Gepulverte Teile/
powder-coating

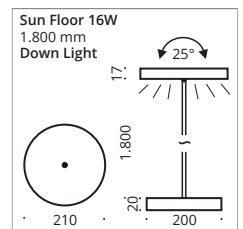
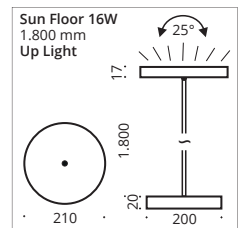
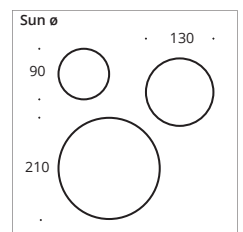
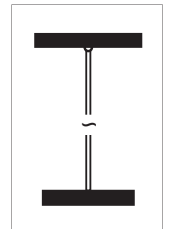

chrome



Puk Maxx Eye Table

TISCHLEUCHTEN

TABLE LAMPS



Puk Mini Spot 269
Puk Maxx Spot 271



Puk Mini Eye Table 273
Puk Maxx Eye Table 275
Puk Meg Maxx Eye Table 277



Puk Mini Table 279
Puk Maxx Table 281



Puk Mini Flexlight Table 283



Sun Table 285



Light On 287



Flexlight Table 289





Puk Mini Spot ø 80

LED oder Halogen Tischstrahler, der gezielt seinen Spot auf die wichtigen Dinge im Raum richtet. Mit Kabelschalter oder optional mit Schnur-Tast-Dimmer, um über 360° drehbar. Der Leuchtenkopf ist schwenkbar. Die Standardausstattung ist mit schwarzem Textilkabel.

LED or Halogen Table spotlight which directs its focus on the important things in the room. With cable switch or optionally with cord touch dimmer. Can be rotated by over 360°. Standard: black textile cable.

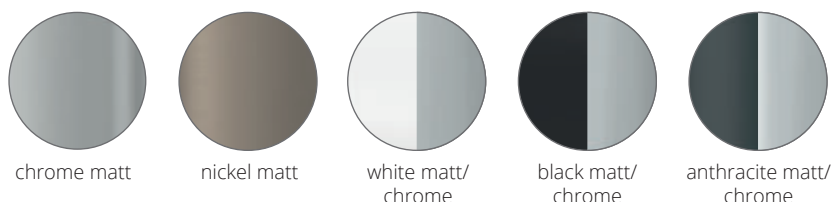

Puk Mini Spot LED G 8W, ~600lm ~2.700k	Puk Mini Spot G9 Fassung	Fuß ø base ø in mm	Gehäuse body
6-901401	6-901401-H	130	chrome matt
6-901402	6-901402-H	130	chrome
6-901403	6-901403-H	130	nickel matt
6-901402-22	6-901402-H-22	130	white matt/chr.
6-901402-02	6-901402-H-02	130	black matt/chr.
6-901402-23	6-901402-H-23	130	anthracite matt/chr.

-D Für Schnur-Dimmer »-D« an die Art.-Nr. hängen
Attach »-D« behind the item no. for a dimmer

- ▶ Ohne Zubehör. Bestell-Artikelnummern für Linse, Glas, Farbfilter und die Konfigurationsempfehlung auf der Einklappseite!
- ▶ Without accessories: Order item-no. for lens, glass, color filter and the recommended Configuration are on the fold-in page!

Leuchtmittelangabe: LED **G** inkl. | G9 max. 33W ECO, optional LED Retrofit
lamp information: LED **G** incl. | G9 max. 33W ECO, LED Retrofit optional

Leuchtmittelempfehlung: LED max. 3W/300lm/2.700K/dimmbar **G** Art Nr. 8-205
bulb recommendation: LED max. 3W/300Lm/2.700K/dimmable **G** Item No. 8-205



- Chrom Teile/
chrome parts
- Gepulverte Teile/
powder-coating

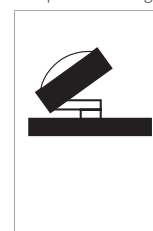
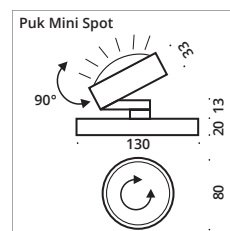





Puk Maxx Spot \varnothing 120

LED oder Halogen Tischstrahler, der gezielt seinen Spot auf die wichtigen Dinge im Raum richtet. Mit Kabelschalter oder optional mit Schnur-Tast-Dimmer, um über 360 Grad drehbar. Der Leuchtenkopf ist schwenkbar. Die Standardausstattung ist mit schwarzem Textilkabel.

LED or Halogen Table spotlight which directs its focus on the important things in the room. With cable switch or optionally with cord touch dimmer. Can be rotated by over 360°. Standard: black textile cable.

INDOOR

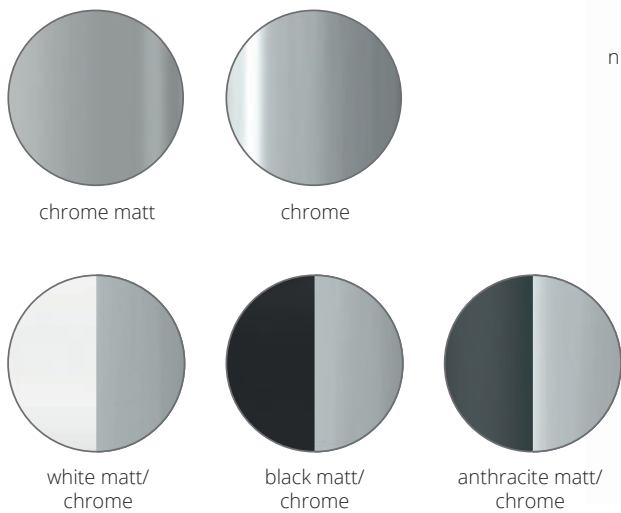

nickel matt

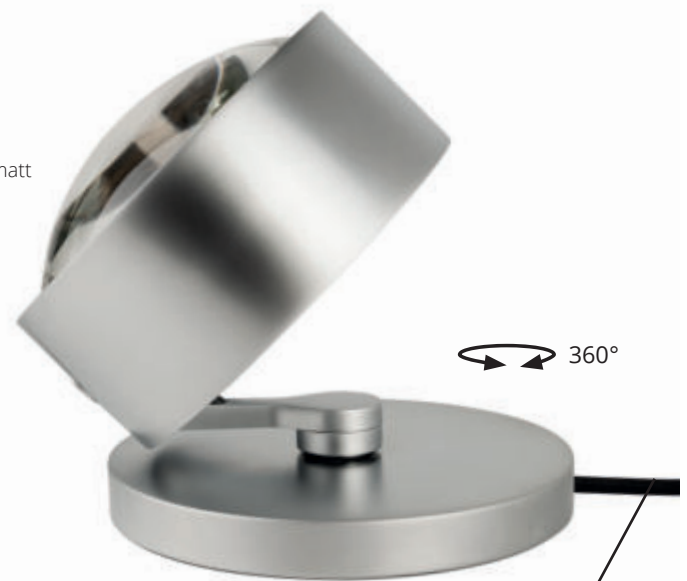

Optional Kabelvarianten.
Optional cable.

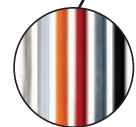

Puk Maxx Spot LED G 1 x 12W ~900lm ~2.700k	Puk Maxx Spot G9 Fassung	Fuß \varnothing base \varnothing in mm	Gehäuse body
	6-981401-H	130	chrome matt
	6-981402-H	130	chrome
	6-981403-H	130	nickel matt
	6-981402-H-22	130	white matt/chr.
	6-981402-H-02	130	black matt/chr.
	6-981402-H-23	130	anthracite matt/chr.

-D Für Schnur-Dimmer »-D« an die Art.-Nr. hängen
Attach »-D« behind the item no. for a dimmer

▶ Ohne Zubehör. Bestell-Artikelnummern für Linse, Glas, Farbfilter und die Konfigurationsempfehlung auf der Einklappseite!

▶ Without accessories: Order item-no. for lens, glass, color filter and the recommended Configuration are on the fold-in page!



Leuchtmittelangabe: LED **G** inkl. | G9 max. 33W ECO, optional LED Retrofit
bulb information: LED **G** incl. | G9 max. 33W ECO, LED Retrofit optional

Leuchtmittelempfehlung: LED max. 3W/300lm/2.700K/dimmbar **G** Art Nr. 8-205
bulb recommendation: LED max. 3W/300Lm/2.700K/dimmable **G** Item No. 8-205



Chrom Teile/
chrome parts
 Gepulverte Teile/
powder-coating

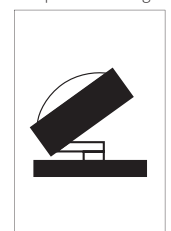
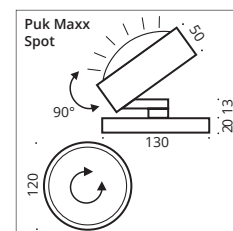



Puk Mini Eye Table



Puk Mini Eye Table ø 80

Tisch- oder Standleuchte, LED Niedervolt mit Tast-Dimmer oder G9 Fassung (mit Schnurschalter, Schnur-Dimmer optional). Die Standardausstattung ist mit schwarzem Textilkabel.

Table or floor lamp. LED low voltage with touch dimmer or G9 socket (with cord switch or cord dimmer, optional). Standard: black textile cable.

INDOOR

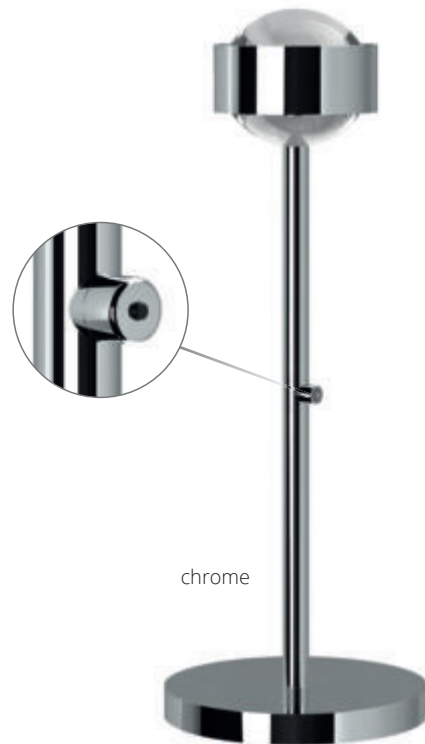
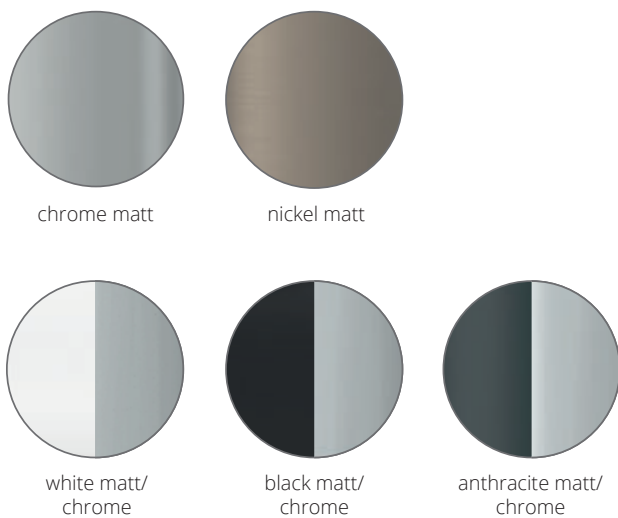

Puk Meg Maxx Eye G9 Fassung ON/OFF	Puk Mini Eye NV LED 20W ~2x900lm ~2.700k	Höhe height in mm	Gehäuse body
6-083701-G9	6-083701-NV-LED	370	chrome matt
6-083702-G9	6-083702-NV-LED	370	chrome
6-083703-G9	6-083703-NV-LED	370	nickel matt
6-083702-22-G9	6-083702-NV-LED-22	370	white matt/chr.
6-083702-02-G9	6-083702-NV-LED-02	370	black matt/chr.
6-083702-23-G9	6-083702-NV-LED-23	370	anthracite matt/chr.
6-084701-G9	6-084701-NV-LED	470	chrome matt
6-084702-G9	6-084702-NV-LED	470	chrome
6-084703-G9	6-084703-NV-LED	470	nickel matt
6-084702-22-G9	6-084702-NV-LED-22	470	white matt/chr.
6-084702-02-G9	6-084702-NV-LED-02	470	black matt/chr.
6-084702-23-G9	6-084702-NV-LED-23	470	anthracite matt/chr.

Für Schnur-Dimmer bei G9 Leuchte »-D« an die Art.-Nr. hängen (Hochvolt)
Attach »-D« behind the item no. for a G9 cable dimmer (high voltage)

Die LED Niedervolt Leuchten sind standardmäßig mit Tast-Dimmer ausgestattet
The LED low voltage luminaires are standard equipped with touch dimmer

► Ohne Zubehör. Bestell-Artikelnummern für Linse, Glas, Farbfilter und die Konfigurationsempfehlung auf der Einklappseite!

► Without accessories: Order item-no. for lens, glass, color filter and the recommended Configuration are on the fold-in page!

Leuchtmittelangabe: LED Retrofit **G inkl.** ~3Watt ~300lm ~2.700K | G9 max. 33W ECO
lamp information: LED Retrofit **G incl.** ~3Watt ~300lm ~2.700K | G9 max. 33W ECO

Leuchtmittelpfehlung: LED max. 3W/300lm/2.700K/dimmbar **G** Art Nr. 8-205
bulb recommendation: LED max. 3W/300Lm/2.700K/dimmable **G** Item No. 8-205

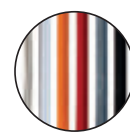

Optional Kabelvarianten.
Optional cable.



Eye Konfiguration (Empfehlung)
Eye Configuration (recommendation)

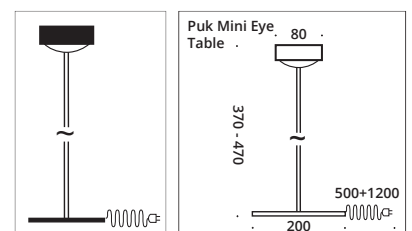
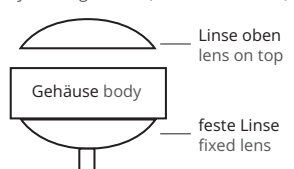





Puk Maxx Eye Table ø 120

Tisch- oder Stehleuchte mit fester Linse, LED Niedervolt mit Tast-Dimmer oder G9 Fassung (mit Schnurschalter, Schnur-Dimmer optional). Die Standardausstattung ist mit schwarzem Textilkabel.

Table or floor lamp. LED low voltage with touch dimmer or G9 socket (with cord switch or cord dimmer, optional). Standard: black textile cable.

INDOOR

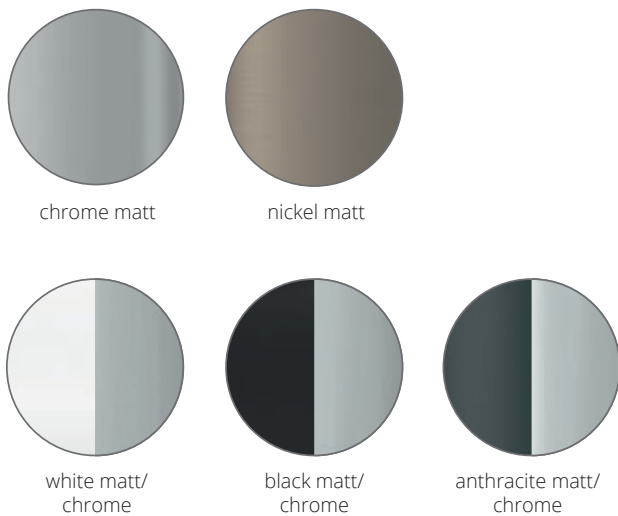

Puk Meg Maxx Eye G9 Fassung ON/OFF	Puk Maxx Eye NV LED 20W ~2x900lm ~2.700k	Höhe height in mm	Gehäuse body
6-383701-G9	6-383701-NV-LED	370	chrome matt
6-383702-G9	6-383702-NV-LED	370	chrome
6-383703-G9	6-383703-NV-LED	370	nickel matt
6-383702-22-G9	6-383702-NV-LED-22	370	white matt/chr.
6-383702-02-G9	6-383702-NV-LED-02	370	black matt/chr.
6-383702-23-G9	6-383702-NV-LED-23	370	anthracite matt/chr.
6-384701-G9	6-384701-NV-LED	470	chrome matt
6-384702-G9	6-384702-NV-LED	470	chrome
6-384703-G9	6-384703-NV-LED	470	nickel matt
6-384702-22-G9	6-384702-NV-LED-22	470	white matt/chr.
6-384702-02-G9	6-384702-NV-LED-02	470	black matt/chr.
6-384702-23-G9	6-384702-NV-LED-23	470	anthracite matt/chr.

Für Schnur-Dimmer bei G9 Leuchte »-D« an die Art.-Nr. hängen (Hochvolt)
Attach »-D« behind the item no. for a G9 cable dimmer (high voltage)

Die LED Niedervolt Leuchten sind standardmäßig mit Tast-Dimmer ausgestattet
The LED low voltage luminaires are standard equipped with touch dimmer

- ▶ Ohne Zubehör. Bestell-Artikelnummern für Linse, Glas, Farbfilter und die Konfigurationsempfehlung auf der Einklappseite!
- ▶ Without accessories: Order item-no. for lens, glass, color filter and the recommended Configuration are on the fold-in page!



Leuchtmittelangabe: LED Retrofit **G inkl.** ~3Watt ~300lm ~2.700K | G9 max. 33W ECO
lamp information: LED Retrofit **G incl.** ~3Watt ~300lm ~2.700K | G9 max. 33W ECO

Leuchtmittelempfehlung: LED max. 3W/300lm/2.700K/dimmbar **G** Art Nr. 8-205
bulb recommendation: LED max. 3W/300lm/2.700K/dimmable **G** Item No. 8-205

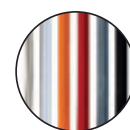

Optional Kabelvarianten.
Optional cable.



Eye Konfiguration (Empfehlung) Eye Configuration (recommendation)

- Chrom Teile/
chrome parts
- Gepulverte Teile/
powder-coating

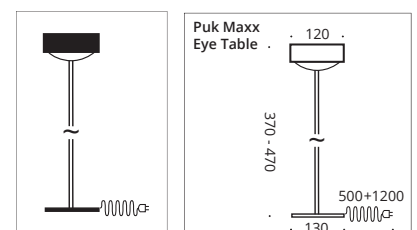
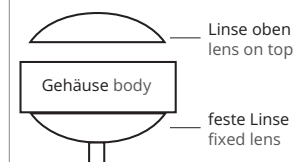



Puk Meg Maxx Eye Table



Puk Meg Maxx Eye Table ø 160

Tisch- oder Stehleuchte mit fester Linse, LED Niedervolt mit Tast-Dimmer oder G9 Fassung (mit Schnurschalter, Schnur-Dimmer optional). Die Standardausstattung ist mit schwarzem Textilkabel.

Table or floor lamp. LED low voltage with touch dimmer or G9 socket (with cord switch or cord dimmer, optional). Standard: black textile cable.

INDOOR

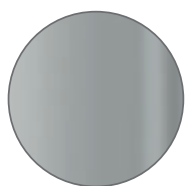

chrome matt



nickel matt

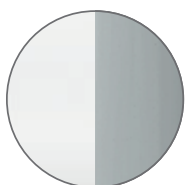

white matt/
chrome

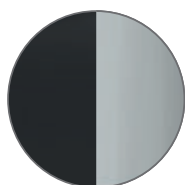

black matt/
chrome

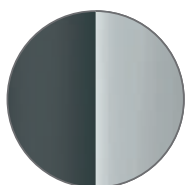

anthracite matt/
chrome



chrome

Puk Meg Maxx Eye G9 Fassung ON/OFF	Puk Meg Maxx Eye NV LED 20W ~2x900lm ~2.700k	Höhe height in mm	Gehäuse body
6-403701-G9	6-403701-NV-LED	370	chrome matt
6-403702-G9	6-403702-NV-LED	370	chrome
6-403703-G9	6-403703-NV-LED	370	nickel matt
6-403702-22-G9	6-403702-NV-LED-22	370	white matt/chr.
6-403702-02-G9	6-403702-NV-LED-02	370	black matt/chr.
6-403702-23-G9	6-403702-NV-LED-23	370	anthracite matt/chr.
6-404701-G9	6-404701-NV-LED	470	chrome matt
6-404702-G9	6-404702-NV-LED	470	chrome
6-404703-G9	6-404703-NV-LED	470	nickel matt
6-404702-22-G9	6-404702-NV-LED-22	470	white matt/chr.
6-404702-02-G9	6-404702-NV-LED-02	470	black matt/chr.
6-404702-23-G9	6-404702-NV-LED-23	470	anthracite matt/chr.

Für Schnur-Dimmer bei G9 Leuchte »-D« an die Art.-Nr. hängen (Hochvolt)
Attach »-D« behind the item no. for a G9 cable dimmer (high voltage)

Die LED Niedervolt Leuchten sind standardmäßig mit Tast-Dimmer ausgestattet
The LED low voltage luminaires are standard equipped with touch dimmer

- ▶ Ohne Zubehör. Bestell-Artikelnummern für Linse, Glas, Farbfilter und die Konfigurationsempfehlung auf der Einklappseite!
- ▶ Without accessories: Order item-no. for lens, glass, color filter and the recommended Configuration are on the fold-in page!



Leuchtmittelangabe: LED Retrofit **G inkl.** ~3Watt ~300lm ~2.700K | G9 max. 33W ECO
lamp information: LED Retrofit **G incl.** ~3Watt ~300lm ~2.700K | G9 max. 33W ECO

Leuchtmittlempfehlung: LED max. 3W/300lm/2.700K/dimmbar **G** Art Nr. 8-205
bulb recommendation: LED max. 3W/300Lm/2.700K/dimmable **G** Item No. 8-205



Optional Kabelvarianten.
Optional cable.



Eye Konfiguration (Empfehlung) Eye Configuration (recommendation)

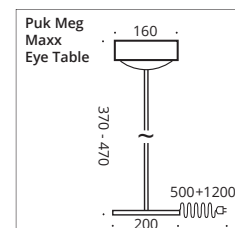
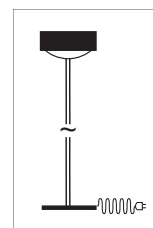
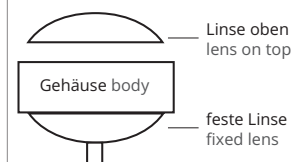



Puk Mini Table Single



Puk Mini Table ø 80

Tischleuchte, LED Niedervolt mit Tast-Dimmer oder G9 Fassung (mit Schnurschalter, Schnur-Dimmer optional), Köpfe drehbar mit Verstellstift, Arm schwenkbar. Die Standardausstattung ist mit schwarzem Textilkabel.

Table lamp, LED low voltage with touch dimmer or G9 socket (with cord switch or cord dimmer, optional), heads rotatable with adjustment pin, arm swivelling. Standard: black textile cable.

INDOOR

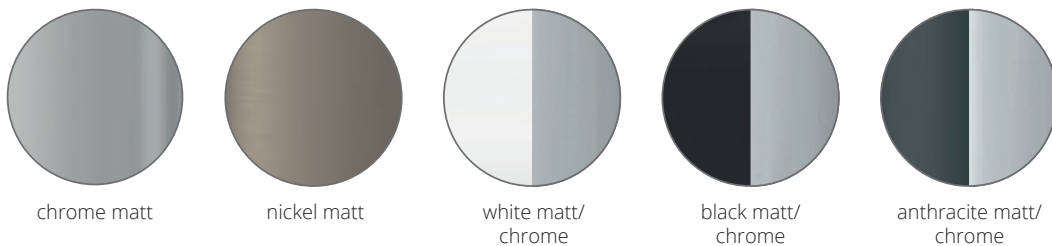

Puk Mini Table G9 Fassung ON/OFF	Puk Mini Table NV LED ~2.700k	Armlänge arm length in mm	Gehäuse body
Single	Single 20W, ~2x900lm		
6-08601-1-G9	6-08601-1-NV-LED	600	chrome matt
6-08602-1-G9	6-08602-1-NV-LED	600	chrome
6-08603-1-G9	6-08603-1-NV-LED	600	nickel matt
6-08602-1-22-G9	6-08602-1-NV-LED-22	600	white matt/chr.
6-08602-1-02-G9	6-08602-1-NV-LED-02	600	black matt/chr.
6-08602-1-23-G9	6-08602-1-NV-LED-23	600	anthracite matt/chr.
Single	Single 20W, ~2x900lm		
6-08801-1-G9	6-08801-1-NV-LED	800	chrome matt
6-08802-1-G9	6-08802-1-NV-LED	800	chrome
6-08803-1-G9	6-08803-1-NV-LED	800	nickel matt
6-08802-1-22-G9	6-08802-1-NV-LED-22	800	white matt/chr.
6-08802-1-02-G9	6-08802-1-NV-LED-02	800	black matt/chr.
6-08802-1-23-G9	6-08802-1-NV-LED-23	800	anthracite matt/chr.
Twin	Twin 20W, ~4x600lm		
6-08601-2-G9	6-08601-2-NV-LED	600	chrome matt
6-08602-2-G9	6-08602-2-NV-LED	600	chrome
6-08603-2-G9	6-08603-2-NV-LED	600	nickel matt
6-08602-2-22-G9	6-08602-2-NV-LED-22	600	white matt/chr.
6-08602-2-02-G9	6-08602-2-NV-LED-02	600	black matt/chr.
6-08602-2-23-G9	6-08602-2-NV-LED-23	600	anthracite matt/chr.
Twin	Twin 20W, ~4x600lm		
6-08801-2-G9	6-08801-2-NV-LED	800	chrome matt
6-08802-2-G9	6-08802-2-NV-LED	800	chrome
6-08803-2-G9	6-08803-2-NV-LED	800	nickel matt
6-08802-2-22-G9	6-08802-2-NV-LED-22	800	white matt/chr.
6-08802-2-02-G9	6-08802-2-NV-LED-02	800	black matt/chr.
6-08802-2-23-G9	6-08802-2-NV-LED-23	800	anthracite matt/chr.



chrome



Optional Kabelvarianten.
Optional cable.



Für Schnur-Dimmer bei G9 Leuchte »-D« an die Art.-Nr. hängen (Hochvolt)
Attach »-D« behind the item no. for a G9 cable dimmer (high voltage)

Die LED Niedervolt Leuchten sind standardmäßig mit Tast-Dimmer ausgestattet
The LED low voltage luminaires are standard equipped with touch dimmer

- ▶ Ohne Zubehör. Bestell-Artikelnummern für Linse, Glas, Farbfilter und die Konfigurationsempfehlung auf der Einklappseite!
- ▶ Without accessories: Order item-no. for lens, glass, color filter and the recommended Configuration are on the fold-in page!



Leuchtmittelangabe: LED Retrofit **G inkl.** ~3Watt ~300lm ~2.700K | G9 max. 33W ECO
lamp information: LED Retrofit **G incl.** ~3Watt ~300lm ~2.700K | G9 max. 33W ECO

Leuchtmittellempfehlung: LED max. 3W/300lm/2.700K/dimmbar **G** Art Nr. 8-205
bulb recommendation: LED max. 3W/300lm/2.700K/dimmable **G** Item No. 8-205

- Chrom Teile/
chrome parts
- Gepulverte Teile/
powder-coating

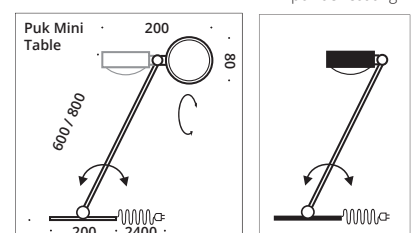





Puk Maxx Table ø 120

Tischleuchte mit einem Leuchtenkopf, LED Niedervolt mit Tast-Dimmer oder G9 Fassung (mit Schnurschalter, Schnur-Dimmer optional), Kopf drehbar, Arm schwenkbar. Die Standardausstattung ist mit schwarzem Textilkabel.

Table lamp, LED low voltage with touch dimmer or G9 socket (with cord switch or cord dimmer, optional), heads rotatable with adjustment pin, arm swivelling. Standard: black textile cable.

INDOOR

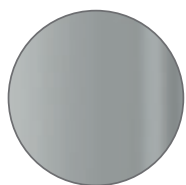

chrome matt



nickel matt

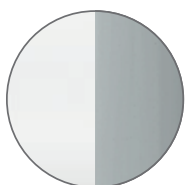

white matt/
chrome

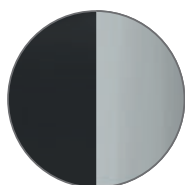

black matt/
chrome

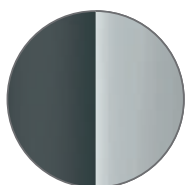

anthracite matt/
chrome



chrome

Puk Maxx Floor Mother-Kid G9 Fassung	Puk Maxx Table NV LED	Armlänge arm length in mm	Gehäuse body
ON/OFF	20W ~2x900lm ~2.700k		
6-38601-G9	6-38601-NV-LED	600	chrome matt
6-38602-G9	6-38602-NV-LED	600	chrome
6-38603-G9	6-38603-NV-LED	600	nickel matt
6-38602-22-G9	6-38602-NV-LED-22	600	white matt/chr.
6-38602-02-G9	6-38602-NV-LED-02	600	black matt/chr.
6-38602-23-G9	6-38602-NV-LED-23	600	anthracite matt/chr.
6-38801-G9	6-38801-NV-LED	800	chrome matt
6-38802-G9	6-38802-NV-LED	800	chrome
6-38803-G9	6-38803-NV-LED	800	nickel matt
6-38802-22-G9	6-38802-NV-LED-22	800	white matt/chr.
6-38802-02-G9	6-38802-NV-LED-02	800	black matt/chr.
6-38802-23-G9	6-38802-NV-LED-23	800	anthracite matt/chr.

Für Schnur-Dimmer bei G9 Leuchte »-D« an die Art.-Nr. hängen (Hochvolt)
Attach »-D« behind the item no. for a G9 cable dimmer (high voltage)

Die LED Niedervolt Leuchten sind standardmäßig mit Tast-Dimmer ausgestattet
The LED low voltage luminaires are standard equipped with touch dimmer

▶ Ohne Zubehör. Bestell-Artikelnummern für Linse, Glas, Farbfilter und die Konfigurationsempfehlung auf der Einklappseite!



▶ Without accessories: Order item-no. for lens, glass, color filter and the recommended Configuration are on the fold-in page!

Leuchtmittelangabe: LED Retrofit **G inkl.** ~3Watt ~300lm ~2.700K | G9 max. 33W ECO
lamp information: LED Retrofit **G incl.** ~3Watt ~300lm ~2.700K | G9 max. 33W ECO

Leuchtmittelpfehlung: LED max. 3W/300lm/2.700K/dimmbar **G** Art Nr. 8-205
bulb recommendation: LED max. 3W/300Lm/2.700K/dimmable **G** Item No. 8-205



Optional Kabelvarianten.
Optional cable.



- Chrom Teile/
chrome parts
- Gepulverte Teile/
powder-coating

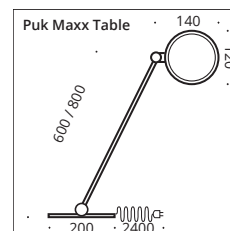
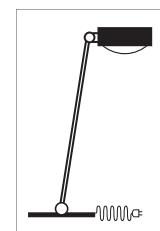



Puk Flexlight Table



Puk Mini Flexlight Table \varnothing 80

Kombinieren Sie den Puk-Kopf, Halogen oder LED, mit Flexarm und Ihrer Wunschbasis, Gläser/Linsen und Farbfilter werden separat dazubestellt. Die Standardausstattung ist mit Schnurschalter und schwarzem Textilkabel.

Combine the Puk head, Halogen or LED, with flex arm and your desired base. Glasses/lenses and colour filters are sold separately. Standard: black textile cable.

INDOOR

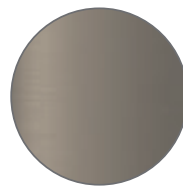

nickel matt



chrome

Puk Flexlight Table LED G 2 x 8W, ~1.200lm, ~2.700k	Puk Flexlight Table G9 Fassung	Armlänge arm length in mm	Gehäuse body
3-7020114-LED	3-7020114	200	chrome
3-7020214-LED	3-7020214	200	nickel matt
3-7030114-LED	3-7030114	300	chrome
3-7030214-LED	3-7030214	300	nickel matt

Für Schnur-Dimmer »-D« an die Art.-Nr. hängen (Hochvolt)
Attach »-D« behind the item no. for a cable dimmer (high voltage)

- ▶ Ohne Zubehör. Bestell-Artikelnummern für Linse, Glas, Farbfilter und die Konfigurationsempfehlung auf der Einklappseite!
- ▶ Without accessories: Order item-no. for lens, glass, color filter and the recommended Configuration are on the fold-in page!



G9 max. 33W, optional LED Retrofit
 G9 max. 33W, LED Retrofit optional

Leuchtmittelempfehlung: LED max. 3W/300lm/2.700K/dimmbar **G** Art Nr. 8-205
 bulb recommendation: LED max. 3W/300Lm/2.700K/dimmable **G** Item No. 8-205

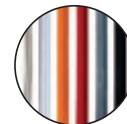

Optional Kabelvarianten.
Optional cable.

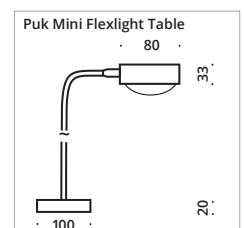

C (s.S 6-7/s.p. 6-7)



Sun Table



Sun Table ø 90/130/210

Der Leuchtenkopf der LED Tischleuchte Sun Table, lässt sich in alle Richtungen über ein Kugelgelenk schwenken. Sie ist in den Durchmessern 90/130/210 mm als Downlight erhältlich. Als Nachttisch-, Fensterbank-, Küchen- oder Schreibtischleuchte findet sie ihren individuellen Einsatz. Die Standardausstattung ist mit Schnurschalter und schwarzem Textilkabel. Optional kann ein Dimmring bestellt werden.

The lamp head of the Sun Table LED table lamp can be swivelled in all directions via a ball joint. It is available in the diameters 90/130/210 mm as downlight. Whether it is used as a bedside, windowsill, kitchen or desk light The standard equipment is with cord switch and black textile cable. A dimming ring can be ordered as an option.

INDOOR

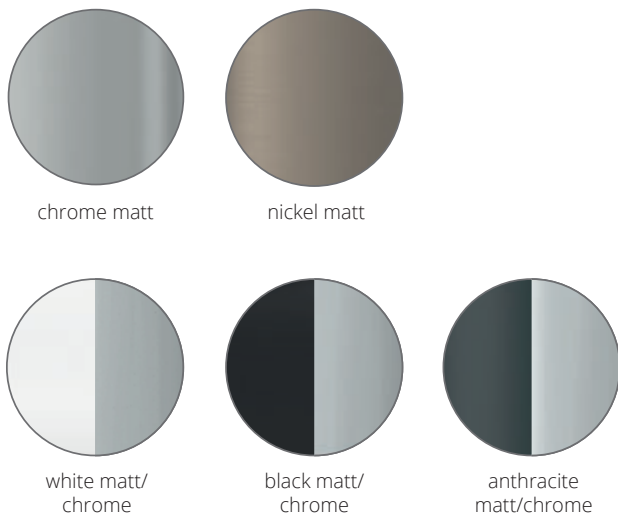

Sun Table LED - ø 90 mm

H 232 mm 90 mm ø G 8 Watt, ~2.700k ~920 lm	H 332 mm 90 mm ø G 8 Watt, ~2.700k ~920 lm	Gehäuse body
● 7-3299011	7-3309011	chrome matt
● 7-3299012	7-3309012	chrome
● 7-3299013	7-3309013	nickel matt
● 7-3299012-22	7-3309012-22	white matt/chr.
● 7-3299012-02	7-3309012-02	black matt/chr.
● 7-3299012-23	7-3309012-23	anthracite matt/chr.
Dimmring Art.-Nr. item no. -DR		chrome

Sun Table LED - ø 130 mm

H 232 mm 130 mm ø G 12 Watt, ~2.700k ~1.300 lm	H 332 mm 130 mm ø G 12 Watt, ~2.700k ~1.300 lm	Gehäuse body
● 7-32913011	7-33013011	chrome matt
● 7-32913012	7-33013012	chrome
● 7-32913013	7-33013013	nickel matt
● 7-32913012-22	7-33013012-22	white matt/chr.
● 7-32913012-02	7-33013012-02	black matt/chr.
● 7-32913012-23	7-33013012-23	anthracite matt/chr.
Dimmring Art.-Nr. item no. -DR		chrome

Sun Table LED - ø 210 mm

H 332 mm 210 mm ø G 16 Watt, ~2.700k ~1.600 lm	H 432 mm 210 mm ø G 16 Watt, ~2.700k ~1.600 lm	Gehäuse body
● 7-33021011	7-33121011	chrome matt
● 7-33021012	7-33121012	chrome
● 7-33021013	7-33121013	nickel matt
● 7-33021012-22	7-33121012-22	white matt/chr.
● 7-33021012-02	7-33121012-02	black matt/chr.
● 7-33021012-23	7-33121012-23	anthracite matt/chr.
Dimmring Art.-Nr. item no. -DR		chrome

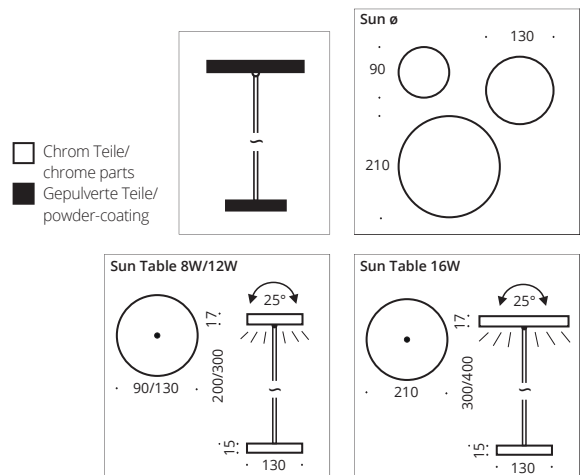





Light On

Schwere Tisch- und Bücherleuchte in Schwarz matt oder Weiß matt, wahlweise mit Puk-Kopf, Pisa-Glas oder Silkschirm. Integrierter Dimmer, mit schwarzem Textilkabel, Schalter und Stecker, Filzboden, Gewicht 4,5 kg.

Heavy table lamp and book light in black matt or white matt. Optional with Puk head, Pisa glass or Silk shade. Integrated dimmer, black textile cable, switch and plug, felt - covered base, weight 4.5 KG.

INDOOR



Puk black matt & white matt



Pisa black matt & white matt



Silk black matt

Kopf Puk Fassung G9	Kopf Pisa Fassung G9	Kopf Silk Fassung E14	Gehäuse body
6-24060344 6-24070304	6-24060343 6-24070303	6-24060347 6-24070305	black matt white matt

Weitere Schirm-Farben für die Silk finden Sie auf der Einklappseite. You can find more colors for the silk shades on the fold in page.

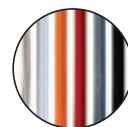

Optional Kabelvarianten. Optional cable.



180° Reflektor optional für Glas Pisa, Art.-Nr. 9-204. 180° Baffle optional for glass Pisa, item number 9-204.

G9 max. 33W ECO, optional LED Retrofit	Leuchtmittlempfehlung: LED max. 3W/300lm/2.700K/dimmbar	Art Nr. 8-205
	bulb recommendation: LED max. 3W/300Lm/2.700K/dimmable	Item No. 8-205
E14 max. 20W, optional LED Retrofit	Leuchtmittlempfehlung: LED max. 6W/470lm/2.700K	Art. Nr. 8-524
	bulb recommendation: LED max. 6W/470Lm/2.700K	Item No. 8-524



Reflektor "Option":
Aluminium-Hochleistungsreflektor, einfache Montage durch Einschub in den Glastubus.

Baffle "option":
High performance aluminium baffle, easy installation: slides into the glass tube.

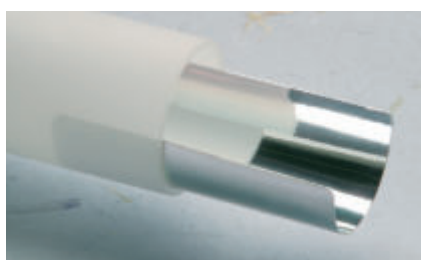

C (s.S 6-7/s.p. 6-7)

Light-on



Flexlight Table Pisa/Silk



Flexlight Table

Individuelle Kopfauswahl auf flexiblem Leuchtenarm und solidem Standfuß. Die Standardausstattung ist mit Schnur- schalter und schwarzem Textilkabel.

Individual luminaire head selection on flexible luminaire arm and solid base. Standard equipment: with cord switch and black textile cable.

INDOOR



Iglo



India



Pisa



Silk



Rio

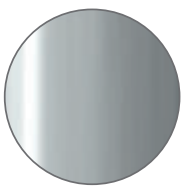

chrome

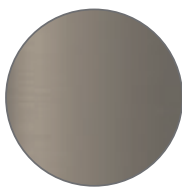

nickel matt

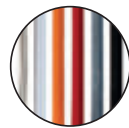

Optional Kabelvarianten.
Optional cable.



	Iglo Table	India Table	Pisa Table	Silk Table	Rio Table	Armlänge arm length in mm	Gehäuse body
	G9 ohne Leuchtmittel without lamp	G9 ohne Leuchtmittel without lamp	G9 ohne Leuchtmittel without lamp	E14 ohne Leuchtmittel without lamp	GU10 ohne Leuchtmittel without lamp		
●	3-7020101	3-7020102	3-7020103	3-7020105	3-7020117	200	chrome
●	3-7020201	3-7020202	3-7020203	3-7020205	3-7020217	200	nickel matt
●	3-7030101	3-7030102	3-7030103	3-7030105	3-7030117	300	chrome
●	3-7030201	3-7030202	3-7030203	3-7030205	3-7030217	300	nickel matt
●	3-7040101	3-7040102	3-7040103	3-7040105	3-7040117	400	chrome
●	3-7040201	3-7040202	3-7040203	3-7040205	3-7040217	400	nickel matt

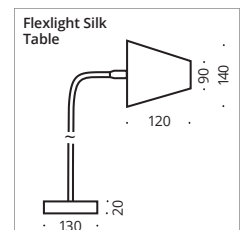

CE LED C IP20 C (s.S 6-7/s.p. 6-7)

● G9 max. 33W ECO, optional LED Retrofit G9 max. 33W ECO, LED Retrofit optional	Leuchtmittlempfehlung: LED max. 3W/300lm/2.700K/dimmbar G bulb recommendation: LED max. 3W/300Lm/2.700K/dimmable G	Art. Nr. 8-205 Item No. 8-205
● E14 max. 20W, optional LED Retrofit E14 max. 20W, LED Retrofit optional	Leuchtmittlempfehlung: LED max. 6W/470lm/2.700K G bulb recommendation: LED max. 6W/470Lm/2.700K G	Art. Nr. 8-524 Item No. 8-524
● GU10 max. 35W, optional LED Retrofit GU10 max. 35W, LED Retrofit optional	Leuchtmittlempfehlung: LED max. 4W/230lm/2.700K G bulb recommendation: LED max. 4W/230Lm/2.700K G	Art. Nr. 8-211 Item No. 8-211

180° Reflektor optional für Glas Pisa, 180° baffle optional for glass Pisa Art.-Nr. 9-204

"Touch me" Dimmer, "Touch me" dimmer Art.-Nr. -D

Weitere Schirm-Farben für die Silk finden Sie auf der Einklappseite. You can find more colors for the silk shades on the fold in page.

SYSTEM

- | | |
|--------------------------------------|-----------|
| 1. Mini Track | 294 - 307 |
| 2. Top Line: Ceiling, Gallery, Crown | 308 - 341 |
| 3. Eutrac | 342 - 347 |

Perfekt zugeschnitten auf jede Art der Illumination sind unsere Leuchtensysteme. Auch anspruchsvolle architektonische Bereiche lassen sich optimal ausleuchten. Dabei kann jeder nach Lust und Laune seinen Geschmack ausleben. Auch lange Flure oder schwierige Ecken lassen sich mit den Schienensystemen leicht überbrücken. Modernste LED Technologie hält dabei die Kosten in Grenzen. Wahlweise sind aber auch Modelle mit Halogenfassung erhältlich.

Our luminaire systems are perfectly tailored to every type of illumination. Even challenging architectural areas can be optimally illuminated. Everyone can live out his or her taste according to desire and taste.. Even long corridors or difficult corners can be easily illuminated with the track systems. State-of-the-art LED technology keeps costs within limits. Models with halogen sockets are also available.







SYSTEMLEUCHTEN SYSTEM LAMPS

1. Mini Track 292 - 307



Puk Mini Turn 299



Puk Mini Eye 299



Puk Mini Side Single 199
Puk Mini Side Twin 301



Puk Mini Long One 301
Puk Maxx Long One 301



Puk Mini Drop 302
Puk Maxx Drop 302



Puk Mini Flex 302



Look at me 303



Pela (Quadro) 303



Sun Ceiling 304



Sun Swing 304/305



Glaslight 305/306
Spotlight 306



Neo 307

2. Top Line 308 - 341



Top Line Ceiling
310 - 319



Top Line Gallery
324 - 329



Top Line Crown
330 - 329



Sun Swing 321



Pela (Quadro) 322



Look at me 323

3. Eutrac 342 - 347



Puk Mini Turn 343
Puk Maxx Turn 345



Puk Mini Eye 343
Puk Maxx Eye 345



Puk Mini Side 343
Puk Maxx Side 345



Puk Mini Flex 343



Puk Maxx Next 345



Puk Mini Long One 343
Puk Maxx Long One 345



Puk Mini Drop 343
Puk Maxx Drop 345



Allround 347

MINI TRACK Components Overview

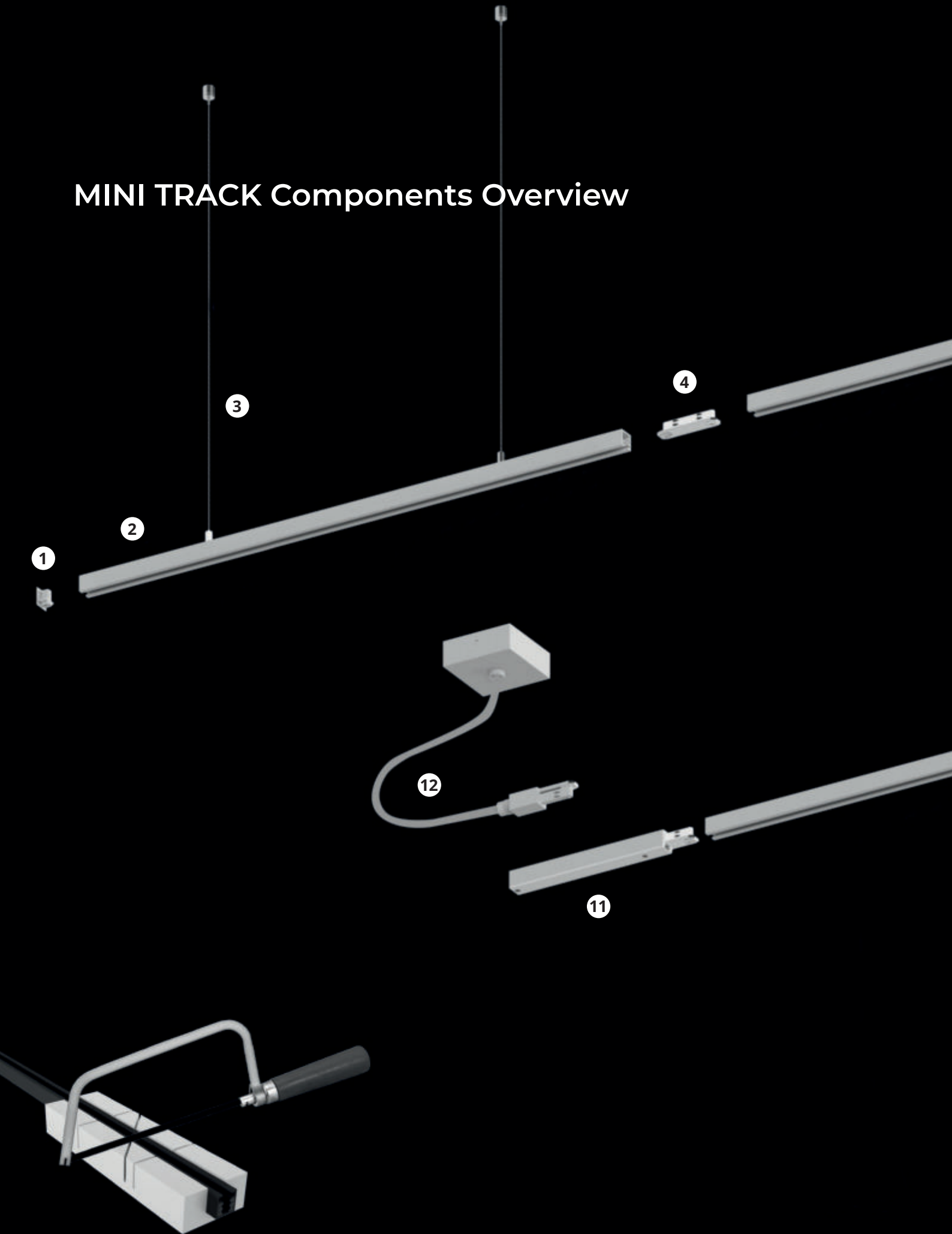

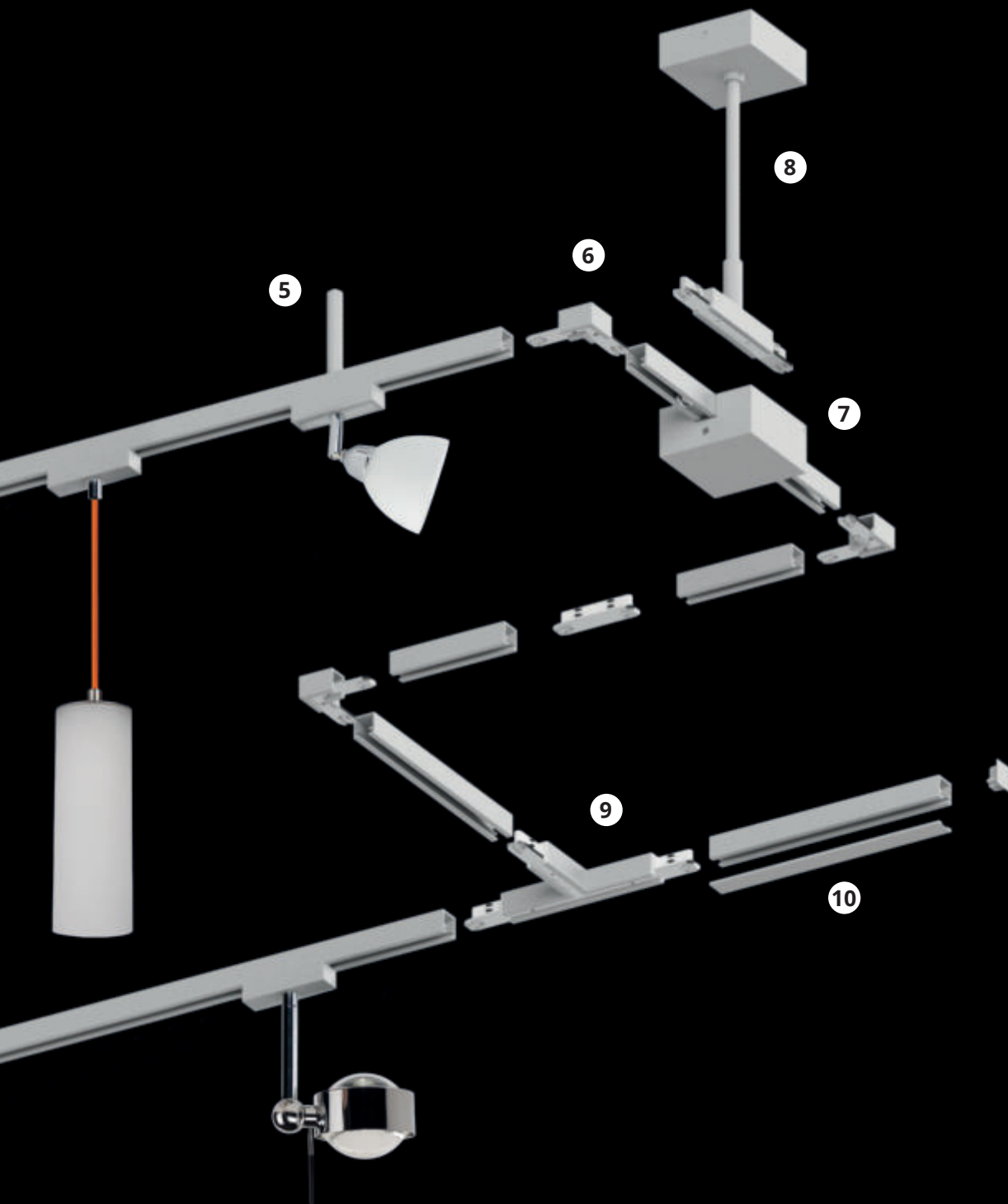

- ① Endkappe / End piece
- ② Profil besonders klein 18 x 18 mm / Profile very small 18 x 18 mm
- ③ Seilabhängung / Steel cable suspension
- ④ Linearverbinder / Linear junction
- ⑤ Deckenbefestigung / Surface mounting
- ⑥ 90° Winkelverbinder / T-Connection
- ⑦ Mitteleinspeisung mit Baldachin / Centre power feed with canopy
- ⑧ Kabelmitteleinspeisung mit Baldachin / Centre cable power feed with canopy
- ⑨ T-Verbinder / T-Connection
- ⑩ Blindabdeckung / Aluminium cover
- ⑪ Endeinspeisung / End power feed
- ⑫ Kabelendeinspeisung mit Baldachin / Cable end power feed with canopy



Art Nr	Farbe	Beschreibung Mini Track	L mm	B mm	H mm
33-102-cr	chrom	2 Phasen Schiene	1000	18	18
33-102-w	weiß	2 Phasen Schiene	1000	18	18
33-102-b	schwarz	2 Phasen Schiene	1000	18	18
33-102-s	natur eloxiert	2 Phasen Schiene	1000	18	18
33-103-cr	chrom	2 Phasen Schiene	2000	18	18
33-103-w	weiß	2 Phasen Schiene	2000	18	18
33-103-b	schwarz	2 Phasen Schiene	2000	18	18
33-103-s	natur eloxiert	2 Phasen Schiene	2000	18	18
33-104-w	weiß	2 Phasen Schiene	2950	18	18
33-104-b	schwarz	2 Phasen Schiene	2950	18	18
33-104-s	natur eloxiert	2 Phasen Schiene	2950	18	18

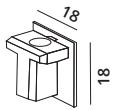

33-105-s	natur eloxiert-silber	Endkappe Schiene	18	18	18
33-105-w	weiß	Endkappe Schiene	18	18	18
33-105-b	schwarz	Endkappe Schiene	18	18	18

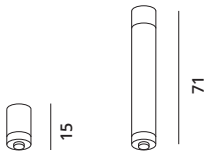

33-106-cr	chrom	Deckenbefestigung	12	12	15
33-106-w	weiß	Deckenbefestigung	12	12	15
33-106-b	schwarz	Deckenbefestigung	12	12	15
33-106-s	natur eloxiert	Deckenbefestigung	12	12	15
33-107-cr	chrom	Deckenbefestigung	12	12	71
33-107-w	weiß	Deckenbefestigung	12	12	71
33-107-b	schwarz	Deckenbefestigung	12	12	71
33-107-s	natur eloxiert	Deckenbefestigung	12	12	71

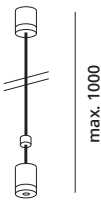

33-108-cr	chrom	Seilabhängung	13	13	1000
33-108-w	weiß	Seilabhängung	13	13	1000
33-108-b	schwarz	Seilabhängung	13	13	1000
33-108-s	natur eloxiert	Seilabhängung	13	13	1000

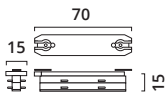

33-109-cr	chrom	Linearverbinder	70	15	15
-----------	-------	-----------------	----	----	----

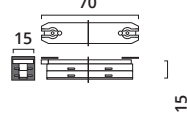

33-110-cr	chrom	Isolierverbinder	70	15	15
-----------	-------	------------------	----	----	----

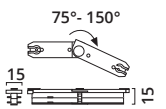

33-111-cr	chrom	Flex-Verbinder 75-150°	110	15	15
-----------	-------	------------------------	-----	----	----

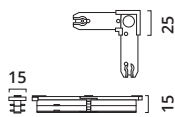

33-112-cr	chrom	Winkelverbinder 90°	25	15	15
33-112-w	weiß	Winkelverbinder 90°	25	15	15
33-112-b	schwarz	Winkelverbinder 90°	25	15	15
33-112-s	natur eloxiert	Winkelverbinder 90°	25	15	15

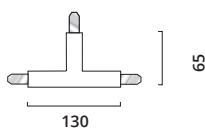

33-113-cr	chrom	T-Verbinder	130	65	18
33-113-w	weiß	T-Verbinder	130	65	18
33-113-b	schwarz	T-Verbinder	130	65	18
33-113-s	natur eloxiert	T-Verbinder	130	65	18

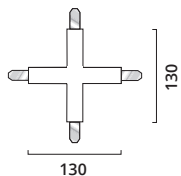

33-114-cr	chrom	Kreuzverbinder	130	130	18
33-114-w	weiß	Kreuzverbinder	130	130	18
33-114-b	schwarz	Kreuzverbinder	130	130	18
33-114-s	natur eloxiert	Kreuzverbinder	130	130	18

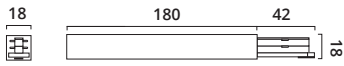

TL Art Nr	Farbe	Beschreibung MINI TRACK	L mm	B mm	H mm
33-115-cr	chrom	Endeinspeisung	180	18	18
33-115-w	weiß	Endeinspeisung	180	18	18
33-115-b	schwarz	Endeinspeisung	180	18	18
33-115-s	natur eloxiert	Endeinspeisung	180	18	18

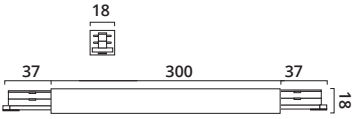

33-116-cr	chrom	Mitteinspeisung	300	18	18
33-116-w	weiß	Mitteinspeisung	300	18	18
33-116-b	schwarz	Mitteinspeisung	300	18	18
33-116-s	natur eloxiert	Mitteinspeisung	300	18	18

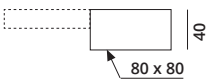

33-117-cr	chrom	Endeinspeisung Baldachin	80	80	40
33-117-w	weiß	Endeinspeisung Baldachin	80	80	40
33-117-b	schwarz	Endeinspeisung Baldachin	80	80	40
33-117-s	natur eloxiert	Endeinspeisung Baldachin	80	80	40

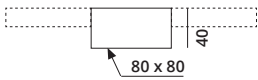

33-118-cr	chrom	Mitteinspeisung Baldachin	80	80	40
33-118-w	weiß	Mitteinspeisung Baldachin	80	80	40
33-118-b	schwarz	Mitteinspeisung Baldachin	80	80	40
33-118-s	natur eloxiert	Mitteinspeisung Baldachin	80	80	40

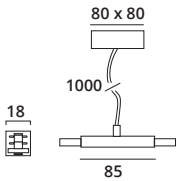

33-119-cr	chrom	Kabelmitteleinspeisung	80	80	1000
33-119-w	weiß	Kabelmitteleinspeisung	80	80	1000
33-119-b	schwarz	Kabelmitteleinspeisung	80	80	1000
33-119-s	natur eloxiert	Kabelmitteleinspeisung	80	80	1000

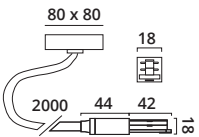

33-120-cr	chrom	Kabelendeinsp. Baldachin	80	80	2000
33-120-w	weiß	Kabelendeinsp. Baldachin	80	80	2000
33-120-b	schwarz	Kabelendeinsp. Baldachin	80	80	2000
33-120-s	natur eloxiert	Kabelendeinsp. Baldachin	80	80	2000

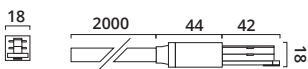

33-121-cr	chrom	Kabelendeinsp.o.Baldachin	18	18	2000
33-121-w	weiß	Kabelendeinsp.o.Baldachin	18	18	2000
33-121-b	schwarz	Kabelendeinsp.o.Baldachin	18	18	2000
33-121-s	natur eloxiert	Kabelendeinsp.o.Baldachin	18	18	2000



33-122-cr	chrom	Adapter für Hängeleuchten	71	18	34
33-122-s	natur eloxiert-silber	Adapter für Hängeleuchten	71	18	34
33-122-w	weiß	Adapter für Hängeleuchten	71	18	34
33-122-b	schwarz	Adapter für Hängeleuchten	71	18	34

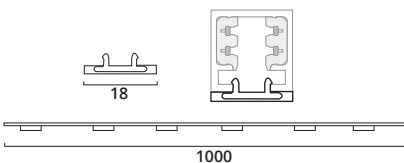

33-123-cr	chrom	Blindabdeckung	1000	18	3
33-123-w	weiß	Blindabdeckung	1000	18	3
33-123-b	schwarz	Blindabdeckung	1000	18	3
33-123-s	natur eloxiert	Blindabdeckung	1000	18	3





PUK TURN
DOWNLIGHT



PUK EYE CEILING
UP & DOWNLIGHT



PUK SIDE SINGLE
UP & DOWNLIGHT

Adapterfarben: für chrommatt = silber, für chrom = chrom, für weiß/chrom = weiß und für schwarz/chrom = schwarz
Adapter Color: for chrom matt = silver, for chrome = chrome, for white/chrome = white and for black/chrome = black



SYSTEM

□ Chrom Teile/
chrome parts
■ Gepulverte Teile/
powdered parts

Puk Turn

LED **G**

Lumen: ~600

Kelvin: ~2.700

Watt: 1 x 8W

📏 : Ø 80mm X H 97mm

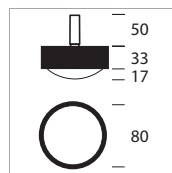

□ Chrom Teile/
chrome parts
■ Gepulverte Teile/
powdered parts

Puk Eye Ceiling

LED **G**

Lumen: ~1.200

Kelvin: ~2.700

Watt: 2 x 8W

📏 : Ø 80mm X H 170mm

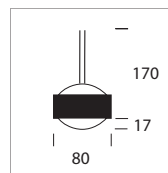

□ Chrom Teile/
chrome parts
■ Gepulverte Teile/
powdered parts

Puk Side Single

LED **G**

Lumen: ~1.200

Kelvin: ~2.700

Watt: 2 x 8W

📏 : Ø 80mm X H 177mm

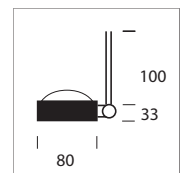

Farbe Color	Art.-Nr. Item-No.
chrome matt	2-38001-LED-MT-C
chrome	2-38002-LED-MT-D
white/chrome	2-3800-22-LED-MT-A
black/chrome	2-3800-02-LED-MT-B

Farbe Color	Art.-Nr. Item-No.
chrome matt	7-75001-MT-C
chrome	7-75002-MT-D
white/chrome	7-7500-22-MT-A
black/chrome	7-7500-02-MT-B

Farbe Color	Art.-Nr. Item-No.
chrome matt	2-0821-LED-MT-C
chrome	2-0822-LED-MT-D
white/chrome	2-082-22-LED-MT-A
black/chrome	2-082-02-LED-MT-B

Bei den Puk Leuchten werden zu dem Leuchtenkopf die Gläser/Linsen und optional die Farbfilter separat dazubestellt. Artikelnummern entnehmen Sie bitte der Equipment-Tabelle auf der Einklappseite.

With the Puk lamps, the glasses, lenses and optional the color filters are ordered separately. Please check the equipment list on the fold-in page for item numbers.





PUK SIDE TWIN
UP & DOWNLIGHT



PUK LONG ONE
DOWNLIGHT



PUK MAXX LONG ONE
DOWNLIGHT

Adapterfarben: für chrommatt = silber, für chrom = chrom, für weiß/chrom = weiß und für schwarz/chrom = schwarz
Adapter Color: for chrom matt = silver, for chrome = chrome, for white/chrome = white and for black/chrome = black

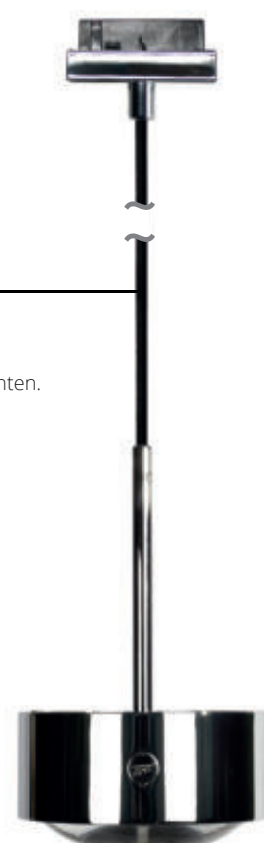
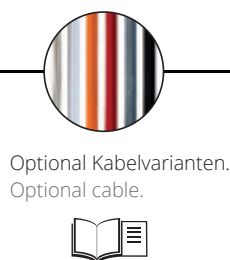

- Chrom Teile/
chrome parts
- Gepulverte Teile/
powdered parts

Puk Side Twin

LED **G**
Lumen: ~2.400
Kelvin: ~2.700
Watt: 4 x 8W
📏 : Ø 80mm X H 177mm

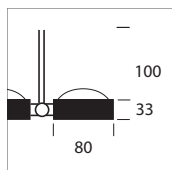

- Chrom Teile/
chrome parts
- Gepulverte Teile/
powdered parts

Puk Long One

LED **G**
Lumen: ~600
Kelvin: ~2.700
Watt: 1 x 8W
📏 : Ø 80mm X H ~1.300mm

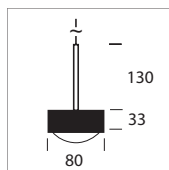

- Chrom Teile/
chrome parts
- Gepulverte Teile/
powdered parts

Puk Maxx Long One

LED **G**
Lumen: ~900
Kelvin: ~2.700
Watt: 1 x 12W
📏 : Ø 120mm X H ~1.300mm

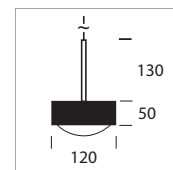

Farbe Color	Art.-Nr. Item-No.
chrome matt	2-0841-LED-MT-C
chrome	2-0842-LED-MT-D
white/chrome	2-084-22-LED-MT-A
black/chrome	2-084-02-LED-MT-B

Farbe Color	Art.-Nr. Item-No.
chrome matt	5-08001-1-LED-MT-C
chrome	5-08002-1-LED-MT-D
white/chrome	5-0800-22-1-LED-MT-A
black/chrome	5-0800-02-1-LED-MT-B

Farbe Color	Art.-Nr. Item-No.
chrome matt	5-38001-MT-C
chrome	5-38002-MT-D
white/chrome	5-3800-22-MT-A
black/chrome	5-3800-02-MT-B

Bei den Puk Leuchten werden zu dem Leuchtenkopf die Gläser/Linsen und optional die Farbfilter separat dazubestellt. Artikelnummern entnehmen Sie bitte der Equipment-Tabelle auf der Einklappseite.

With the Puk lamps, the glasses, lenses and optional the color filters are ordered separately. Please check the equipment list on the fold-in page for item numbers.



PUK DROP
UP & DOWNLIGHT



PUK MAXX DROP
UP & DOWNLIGHT



PUK FLEXLIGHT
UP & DOWNLIGHT

Adapterfarben: für chrommatt = silber, für chrom = chrom, für weiß/chrom = weiß und für schwarz/chrom = schwarz
Adapter Color: for chrom matt = silver, for chrome = chrome, for white/chrome = white and for black/chrome = black

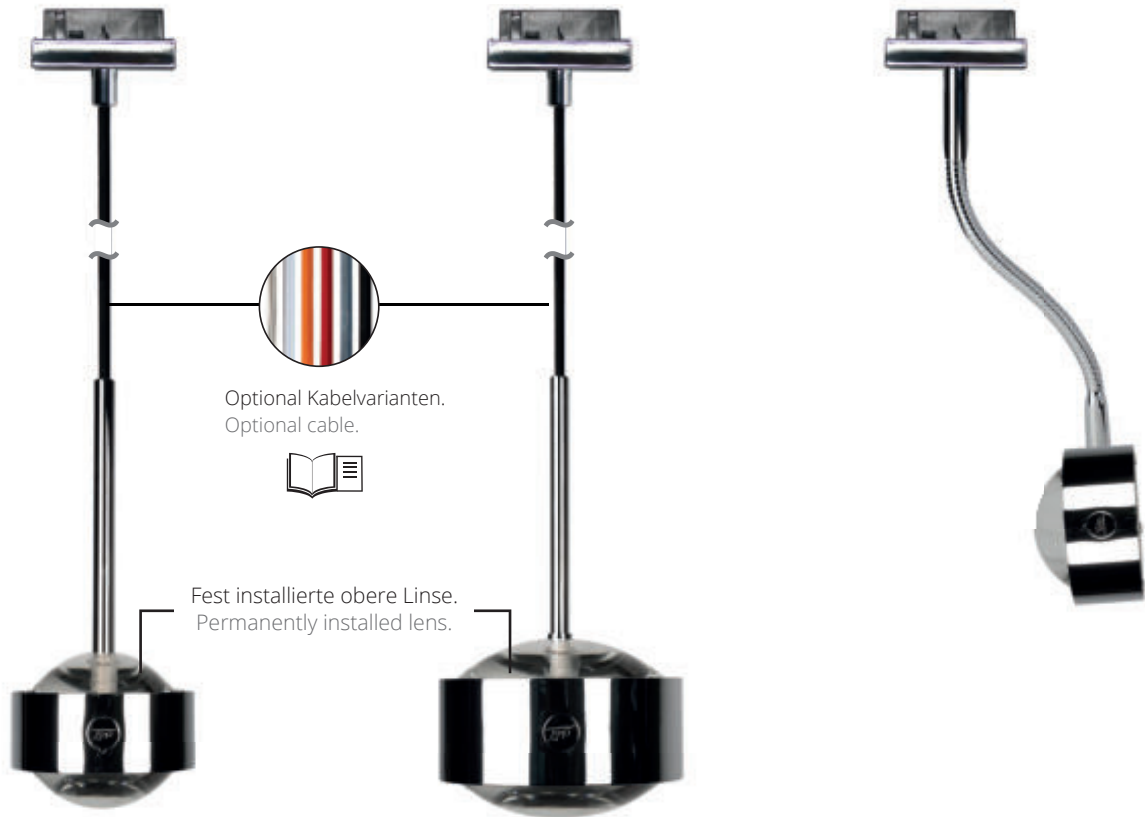

□ Chrom Teile/
chrome parts
■ Gepulverte Teile/
powdered parts

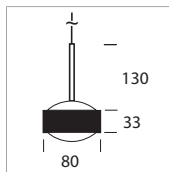

Puk Drop

LED **G**

Lumen: ~1.200

Kelvin: ~2.700

Watt: 2 x 8W

📏 : Ø 80mm X H ~1.300mm

□ Chrom Teile/
chrome parts
■ Gepulverte Teile/
powdered parts

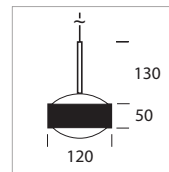

Puk Maxx Drop

LED **G**

Lumen: ~1.800

Kelvin: ~2.700

Watt: 2 x 12W

📏 : Ø 120mm X H ~1.300mm

□ Chrom Teile/
chrome parts
■ Gepulverte Teile/
powdered parts

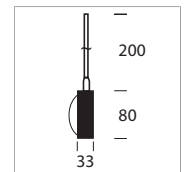

Puk Flexlight

LED **G**

Lumen: ~1.200

Kelvin: ~2.700

Watt: 2 x 8W

📏 : Ø 80mm X H 294mm

Farbe Color	Art.-Nr. Item-No.
chrome matt	5-06001-MT-C
chrome	5-06002-MT-D
white/chrome	5-0600-22-MT-A
black/chrome	5-0600-02-MT-B

Farbe Color	Art.-Nr. Item-No.
chrome matt	5-36001-MT-C
chrome	5-36002-MT-D
white/chrome	5-3600-22-MT-A
black/chrome	5-3600-02-MT-B

Farbe Color	Art.-Nr. Item-No.
chrome	20114-LED-MT-D

Bei den Puk Leuchten werden zu dem Leuchtenkopf die Gläser/Linsen und optional die Farbfilter separat dazubestellt. Artikelnummern entnehmen Sie bitte der Equipment-Tabelle auf der Einklappseite.

With the Puk lamps, the glasses, lenses and optional the color filters are ordered separately. Please check the equipment list on the fold-in page for item numbers.



LOOK AT ME
DOWNLIGHT



PELA
ALL-ROUND LIGHT



PELA QUADRO
ALL-ROUND LIGHT

Adapterfarben: für chrommatt = silber, für chrom = chrom, für weiß = weiß und für schwarz = schwarz
 Adapter Color: for chrom matt = silver, for chrome = chrome, for white = white and for black = black

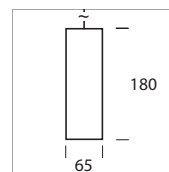
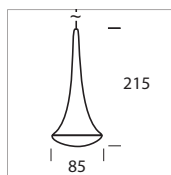

Look at me

LED **G**
 Lumen: ~600
 Kelvin: ~2.700
 Watt: 1 x 8W
 : Ø 85mm X H ~1.300mm

Pela

E27: ohne Leuchtmittel/without bulb
 Lumen: leuchtmittelabhängig
 according to bulb
 Kelvin: leuchtmittelabhängig
 according to bulb
 Watt: max. 1 x 42W optional LED Retrofit
 : Ø 65mm X H ~1.300mm

Pela Quadro

E27: ohne Leuchtmittel/without bulb
 Lumen: leuchtmittelabhängig
 according to bulb
 Kelvin: leuchtmittelabhängig
 according to bulb
 Watt: max. 1 x 42W optional LED Retrofit
 : B 65mm X H ~1.300mm

Farbe Color	Art.-Nr. Item-No.
chrome matt	5-911-1-MT-C
chrome	5-911-2-MT-D
white matt	5-911-22-MT-A
black matt	5-911-02-MT-B
lens clear	2-9126
lens frosted	2-9126-S

Farbe Color	Art.-Nr. Item-No.
chrome	5-07651-MT-D

Farbe Color	Art.-Nr. Item-No.
chrome	5-08651-MT-D

SYSTEM



SUN CEILING
DOWNLIGHT



SUN CEILING
DOWNLIGHT



SUN SWING
DOWNLIGHT

Adapterfarben: für chrommatt = silber, für chrom = chrom, für weiß/chrom = weiß und für schwarz/chrom = schwarz
Adapter Color: for chrom matt = silver, for chrome = chrome, for white/chrome = white and for black/chrome = black



□ Chrom Teile/
chrome parts
■ Gepulverte Teile/
powdered parts

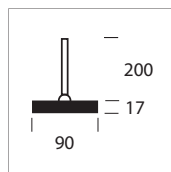

Sun Ceiling

LED **G**

Lumen: ~920

Kelvin: ~2.700

Watt: 1 x 8W

: Ø 90mm X H 231mm



□ Chrom Teile/
chrome parts
■ Gepulverte Teile/
powdered parts

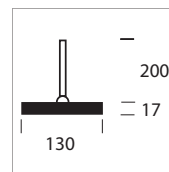

Sun Ceiling

LED **G**

Lumen: ~1.300

Kelvin: ~2.700

Watt: 1 x 12W

: Ø 130mm X H 231mm

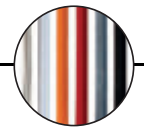
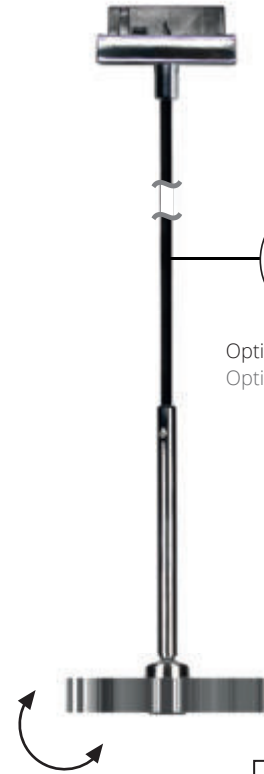

Optional Kabelvarianten.
Optional cable.



□ Chrom Teile/
chrome parts
■ Gepulverte Teile/
powdered parts

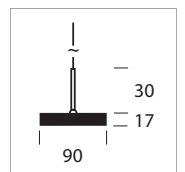

Sun Swing

LED **G**

Lumen: ~920

Kelvin: ~2.700

Watt: 1 x 8W

: Ø 90mm X H ~1.300mm

Farbe Color	Art.-Nr. Item-No.
chrome matt	7-3269011-MT-C
chrome	7-3269012-MT-D
white/chrome	7-32690122-MT-A
black/chrome	7-32690102-MT-B

Farbe Color	Art.-Nr. Item-No.
chrome matt	7-32613011-MT-C
chrome	7-32613012-MT-D
white/chrome	7-326130122-MT-A
black/chrome	7-326130102-MT-B

Farbe Color	Art.-Nr. Item-No.
chrome matt	7-3289011-MT-C
chrome	7-3289012-MT-D
white/chrome	7-32890122-MT-A
black/chrome	7-32890102-MT-B



SUN SWING
DOWNLIGHT



IGLO
ALL-ROUND LIGHT



INDIA
ALL-ROUND LIGHT

Adapterfarben: für chrommatt = silber, für chrom = chrom, für weiß/chrom = weiß und für schwarz/chrom = schwarz
Adapter Color: for chrom matt = silver, for chrome = chrome, for white/chrome = white and for black/chrome = black



□ Chrom Teile/
chrome parts
■ Gepulverte Teile/
powdered parts

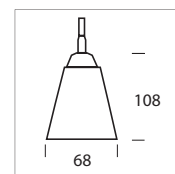
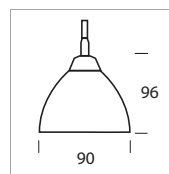
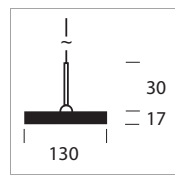

Sun Swing

LED **G**

Lumen: ~1.300

Kelvin: ~2.700

Watt: 1 x 12W

📏 : Ø 130mm X H ~1.300mm

Iglo

G9: ohne Leuchtmittel/without bulb

Lumen: leuchtmittelabhängig
according to bulb

Kelvin: leuchtmittelabhängig
according to bulb

Watt: max. 1 x 33W

📏 : Ø 90mm X H 160mm

India

G9: ohne Leuchtmittel/without bulb

Lumen: leuchtmittelabhängig
according to bulb

Kelvin: leuchtmittelabhängig
according to bulb

Watt: max. 1 x 33W

📏 : Ø 68mm X H 172mm

Farbe Color	Art.-Nr. Item-No.
chrome matt	7-32813011-MT-C
chrome	7-32813012-MT-D
white/chrome	7-3281301-22-MT-A
black/chrome	7-3281301-02-MT-B

Farbe Color	Art.-Nr. Item-No.
chrome	0101-MT-D

Farbe Color	Art.-Nr. Item-No.
chrome	0102-MT-D

SYSTEM



PISA
ALL-ROUND LIGHT



Pisa

G9: ohne Leuchtmittel/without bulb
Lumen: leuchtmittelabhängig/according to bulb
Kelvin: leuchtmittelabhängig/according to bulb
Watt: max. 1 x 33W
📏 : Ø 38mm X H 162mm

Farbe Color	Art.-Nr. Item-No.
chrome	0103-MT-D



PISA DOUBLE
ALL-ROUND LIGHT

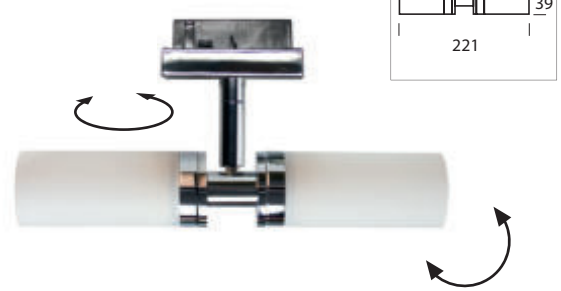

Pisa Double

G9: ohne Leuchtmittel/without bulb
Lumen: leuchtmittelabhängig/according to bulb
Kelvin: leuchtmittelabhängig/according to bulb
Watt: max. 2 x 33W
📏 : Ø 38mm X B 200mm x H 64mm

Farbe Color	Art.-Nr. Item-No.
chrome	0130-MT-D



BULB
ALL-ROUND LIGHT

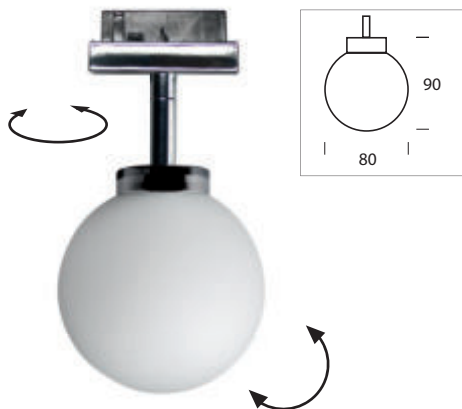

Bulb

G9: ohne Leuchtmittel/without bulb
Lumen: leuchtmittelabhängig/according to bulb
Kelvin: leuchtmittelabhängig/according to bulb
Watt: max. 1 x 33W
📏 : Ø 80mm X H 154mm

Farbe Color	Art.-Nr. Item-No.
chrome	0132-MT-D



RIO
DOWNLIGHT



Rio

GU10: ohne Leuchtmittel/without bulb
Lumen: leuchtmittelabhängig/according to bulb
Kelvin: leuchtmittelabhängig/according to bulb
Watt: max. 1 x 4W LED Retrofit
📏 : Ø 65mm X H 144mm

Farbe Color	Art.-Nr. Item-No.
chrome	0117-MT-D



NEO TRACK
DOWNLIGHT



NEO SWING
DOWNLIGHT



NEO FLEX
DOWNLIGHT

Adapterfarbe: für aluminium = chrom und schwarz
Adapter Color: for aluminium = chrome and black

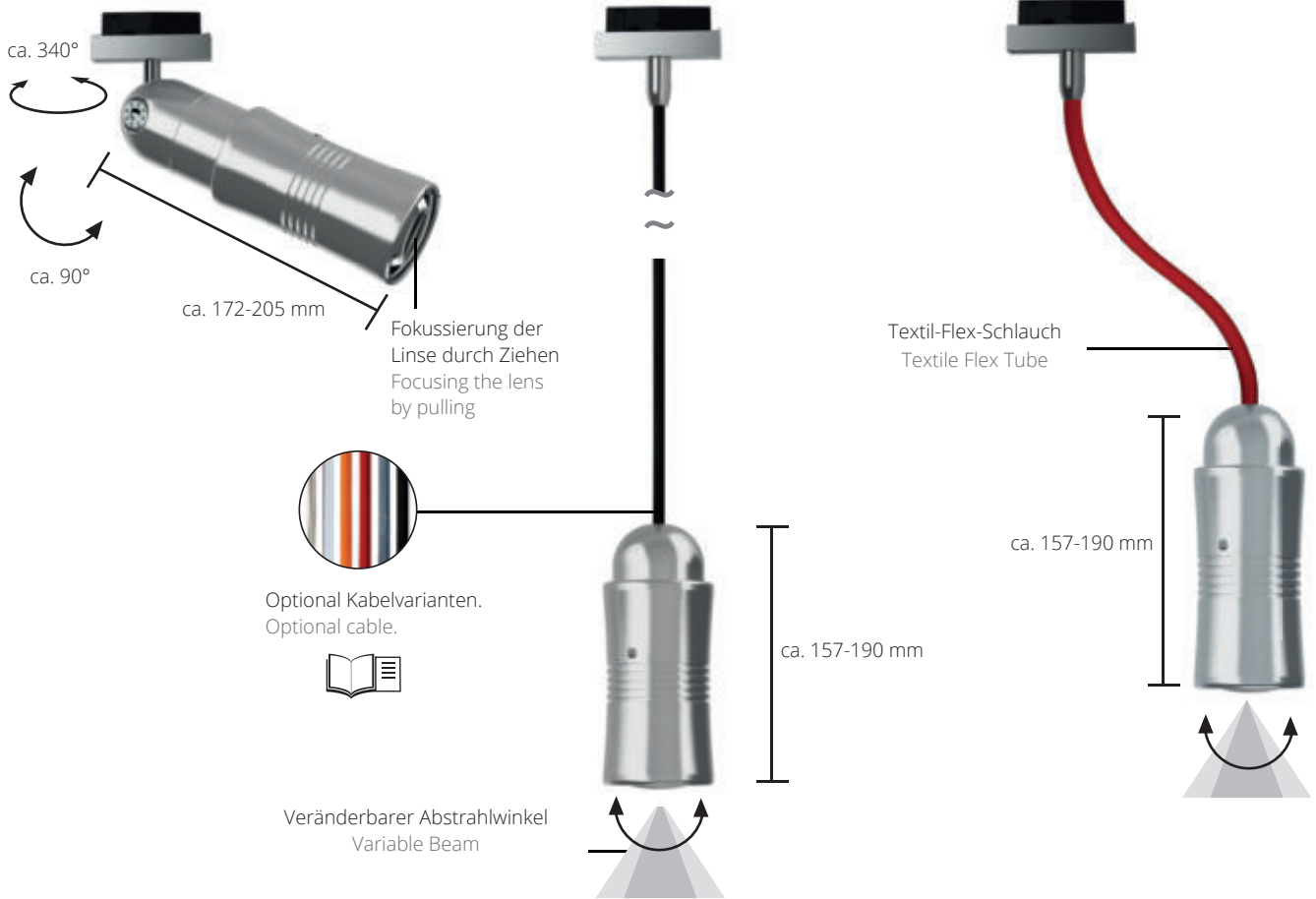

Neo Track

LED **G**
Lumen: ~710
Kelvin: ~2.700
Watt: 1 x 10W
: Ø 65mm X L 172-205mm

Neo Pendant

LED **G**
Lumen: ~710
Kelvin: ~2.700
Watt: 1 x 10W
: Ø 65mm X H ~1.300mm

Neo Flex

LED **G**
Lumen: ~710
Kelvin: ~2.700
Watt: 1 x 10W
: Ø 65mm X H min. 511mm

Farbe Color	Art.-Nr. Item-No.
aluminium	16-02-MT-D

Farbe Color	Art.-Nr. Item-No.
aluminium	16-05-MT-D

Flexarm L	Art.-Nr. Item-No.
300mm red	16-06303-MT-D
300mm black	16-06306-MT-D
300mm grey	16-0630X-MT-D

SYSTEM









Top Line Components Overview

Standardmodelle auf Seite 202-215.

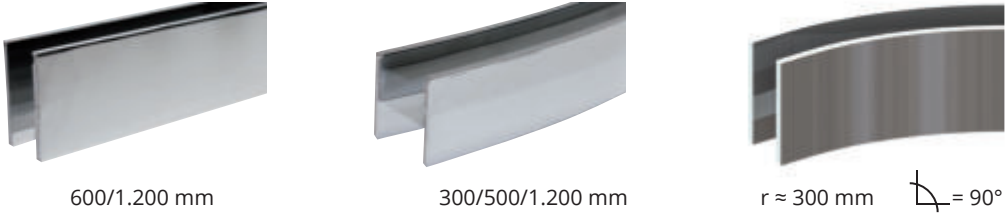
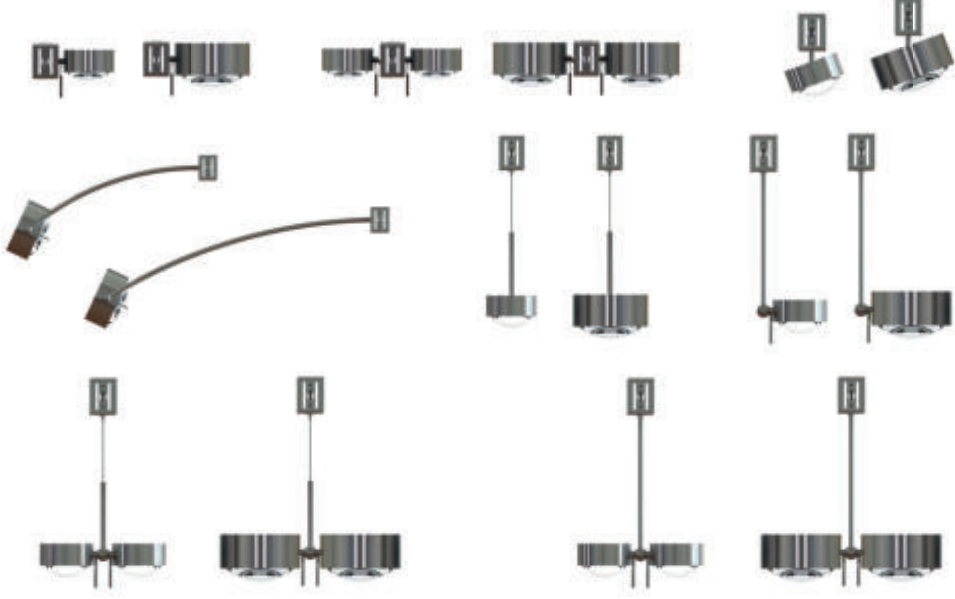
Standard models on page xx.

Abhängung suspension	
Verbinder/Halter/ Endstück connector/holder/ endpiece	
Schienen rails	 <p>600/1.200 mm 300/500/1.200 mm $r \approx 300 \text{ mm}$ $\sphericalangle = 90^\circ$</p>
Köpfe/ Pendel Puk heads/ pendula Puk	
Pendel pendula	

SYSTEM





Top Line System Ceiling

Das Deckenleuchtensystem bietet optimale Flexibilität. Mit dem Doppelschienensystem können beliebige Winkel und Längen abgehängt und mit der gewünschten Anzahl an Leuchten bestückt werden. Egal ob Rohr- oder Seilabhängung, LED Power oder Halogen, das Puk System kreiert ein harmonisches Licht für jeden Bedarf. Hier nur einige Konfigurationsbeispiele.

Our Puk System Ceiling offers an optimum of flexibility. The double rail system can be suspended in every angle and length and equipped with an arbitrary number of lamps. Whether tube or wire suspension, LED or Halogen illumination, the Puk System creates harmoniously illumination. Here are just a few configuration examples.

Beispiele Systemführung & Konfiguration

Rail system & configuration examples

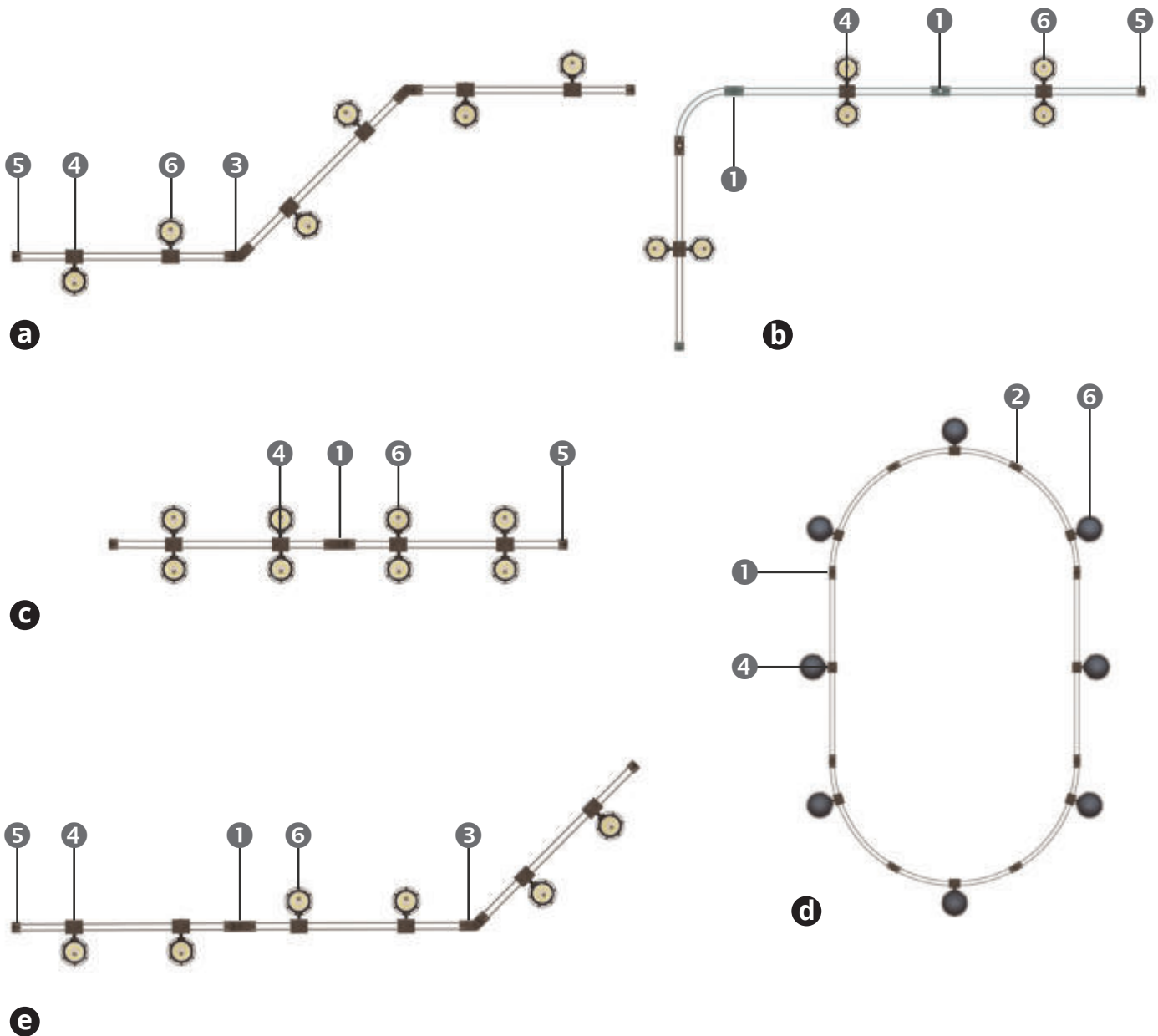

SYSTEM



Bei den Puk Leuchten werden zu dem Leuchtenkopf die Gläser/Linsen und optional die Farbfilter separat dazubestellt! Artikelnummern entnehmen Sie bitte den Equipment-Tabellen auf der Einklappseite.











With the Puk lamps, the glasses, lenses and optional the color filters are ordered separately. Please check the equipment lists on the fold-in page for item numbers.





Konfigurationsmöglichkeiten Configuration Options

Systemabhängungen & Schienenkomponenten System suspensions & rail components

	Seilabhängung wire suspension L=2.000 mm 	Einspeisung mit Seilabhängung feed in incl. wire suspension L=2.000 mm 	Rohrabhängung tube suspension L=100/150/ 200 mm 	Systemeinspeisung* feed-in* 
1 Verbinder gerade straight connector 	✓	✓	✓	nur Einspeisung, keine Abhängung only feed-in, no suspension
2 Verbinder gebogen bent connector 	✓	✓	✓	nur Einspeisung, keine Abhängung only feed-in, no suspension
3 Gelenkverbinder articulated connector 	✓	✓	✓	nur Einspeisung, keine Abhängung only feed-in, no suspension
4 Halter für Kopfmontage mounting support for heads 	✓	✓	✓	nur Einspeisung, keine Abhängung only feed-in, no suspension
5 Schienenendstück railendpiece 	✓	✓	✓	nur Einspeisung, keine Abhängung only feed-in, no suspension
6 Köpfe/Pendel heads/pendula 	✓	✓	✓	nur Einspeisung, keine Abhängung only feed-in, no suspension

SYSTEM

Regulär wird empfohlen, an den Verbindern/Endstücken abzuhängen. Aus optischen oder technischen Gründen kann aber auch auf andere Möglichkeiten, wie die Tabelle zeigt, zurückgegriffen werden. Preise der einzelnen Komponenten des Puk Systems entnehmen Sie bitte der Preisliste.

*beliebige Anbringung der Einspeisung am System

We recommend to hang up the system on the connectors or end pieces. For optical or technical reasons the above listed possibilities can be taken in consideration as well. Prices for parts and components of the PUK System are provided in the Pricelist.

*arbitrary feed-in mounting on the system

Top Line Ceiling components

Standardmodelle auf Seite 218 - 223.

Standard models on page 218 - 223.

SCHIENEN (kürzbar**) / RAILS (can be shortened**) 

Schiene gerade
rail straight

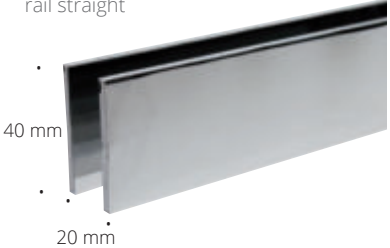

40 mm
20 mm

Doppelschiene Alu/double rail 

Maße/dimensions: B 20 x H 40 mm

Farbe/color	L (mm)	Art.-Nr. item-no.
chrome matt	600	8-070601
chrome	600	8-070602
nickel matt	600	8-070603
chrome matt	1.200	8-0701201
chrome	1.200	8-0701202
nickel matt	1.200	8-0701203

Schiene gebogen
rail bent

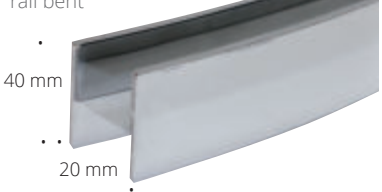

40 mm
20 mm

Doppelschiene Alu/double rail 

Maße/dimensions: B 20 x H 40 mm, r = ... (> 300mm)

Farbe/color	L (mm)	Art.-Nr. item-no.
chrome matt	300	8-060301
chrome	300	8-060302
nickel matt	300	8-060303
chrome matt	500	8-060501
chrome	500	8-060502
nickel matt	500	8-060503
chrome matt	1.200	8-0601201
chrome	1.200	8-0601202
nickel matt	1.200	8-0601203

Eckschiene gebogen 90°
corner rail / bent 90°

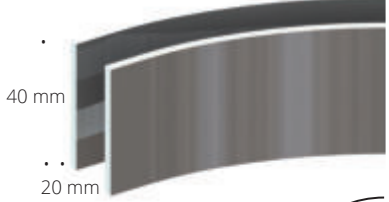

40 mm
20 mm

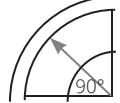

Doppelschiene Alu/double rail 

Maße/dimensions: B 20 x H 40 mm, r ≈ 300mm

Farbe/color	L (mm) Profil rail	Art.-Nr. item-no.
chrome matt	~470	8-080301
chrome	~470	8-080302
nickel matt	~470	8-080303

Fertig gesägt nach Maß und freigegebener Zeichnung. **Art.-Nr. 8-0990

Customized length (after released drawing). **Item no. 8-0990

VERBINDER / CONNECTOR

Verbinder gerade, Abhängung Rohr/Seil
straight connector, suspension tube/wire



Material: Metall/material: metal

Maße/dimensions: B 60 x H 40 x T 30 mm

Farbe/color	Art.-Nr. item-no.
chrome matt	8-0811
chrome	8-0812
nickel matt	8-0813

Verbinder gebogen, Abhängung Rohr/Seil
bent connector, suspension tube/wire



Material: Metall/material: metal

Maße/dimensions: B 60 x H 40 x T 30 mm

Farbe/color	Art.-Nr. item-no.
chrome matt	8-0611
chrome	8-0612
nickel matt	8-0613

Gelenkverbinder, Abhängung Rohr/Seil
articulated connector, suspension tube/wire

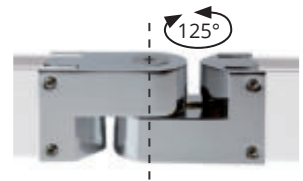

Material: Metall/material: metal

Maße/dimensions: B 90 x H 40 x T 30 mm

Winkel/angle: max. 125°

Farbe/color	Art.-Nr. item-no.
chrome matt	8-0731
chrome	8-0732
nickel matt	8-0733

Adapter für Seilabhängung/for wire suspension

chrome matt	8-0851
chrome	8-0852
nickel matt	8-0853

Adapter für Rohrabhängung/for tube suspension

chrome matt	8-0861
chrome	8-0862
nickel matt	8-0863



Top Line Ceiling components

Standardmodelle auf Seite 218 - 223.

Standard models on page 218 - 223.

HALTER / MOUNTING SUPPORT

Schienehalter beliebig auf Schiene
Abhängung Rohr/Seil
arbitrary support mounting on the rail
suspension tube/wire



Material: Metall/material: metal
Maße/dimensions: B 50 x H 55 x T 40 mm

Farbe/color	Art.-Nr. item-no.
chrome matt	8-0621
chrome	8-0622
nickel matt	8-0623

Schieneendstück (optional)
Abhängung Rohr/Seil
railendpiece (optional)
suspension tube/wire



Material: Metall/material: metal
Maße/dimensions: B 30 x H 40 x T 25 mm

Farbe/color	Art.-Nr. item-no.
chrome matt	8-0841
chrome	8-0842
nickel matt	8-0843

ABHÄNGUNG / SUSPENSION

Rohr Abhängung
tube suspension



Material: Metall/material: metal
Maße/dimensions: H 20 x ø 40 mm

Farbe/color	L mm**	Art.-Nr. item-no.
chrome matt	100	8-06411
chrome	100	8-06412
nickel matt	100	8-06413
chrome matt	200	8-06421
chrome	200	8-06422
nickel matt	200	8-06423
chrome matt	300	8-06431
chrome	300	8-06432
nickel matt	300	8-06433

**Sonderlängen auf Anfrage

**special lengths on request

ABHÄNGUNG / SUSPENSION

Seil Abhängung
wire suspension



Material: Metall/material: metal, max. 29 kg
Maße/dimensions: H 18 x ø 15 mm

Farbe/color	Seil/Rope L mm**	Art.-Nr. item-no.
chrome matt	2.000	8-066120
chrome	2.000	8-066220
nickel matt	2.000	8-066320
chrome matt	5.000	8-066150
chrome	5.000	8-066250
nickel matt	5.000	8-066350

**Sonderlängen auf Anfrage

**special lengths on request

EINSPEISUNG / FEED-IN

Einspeisung mit Abhängung Seil
feed-in with wire suspension



Material: Metall/material: metal
Maße/dimensions: B 65 x H 65 mm

Farbe/color	L mm**	Design	Art.-Nr. item-no.
chrome matt	2.000	<input type="checkbox"/>	8-0661
chrome	2.000	<input type="checkbox"/>	8-0662
nickel matt	2.000	<input type="checkbox"/>	8-0663
chrome matt	2.000	<input type="radio"/>	8-0671
chrome	2.000	<input type="radio"/>	8-0672
nickel matt	2.000	<input type="radio"/>	8-0673

**Sonderlängen auf Anfrage

**special lengths on request

Einspeisung ohne Abhängung
feed-in without wire suspension



Material: Metall/material: metal
Maße/dimensions: B 65 x H 65 mm

Farbe/color	L mm**	Design	Art.-Nr. item-no.
chrome matt	2.000	<input type="checkbox"/>	8-0681
chrome	2.000	<input type="checkbox"/>	8-0682
nickel matt	2.000	<input type="checkbox"/>	8-0683
chrome matt	2.000	<input type="radio"/>	8-0691
chrome	2.000	<input type="radio"/>	8-0692
nickel matt	2.000	<input type="radio"/>	8-0693

**Sonderlängen auf Anfrage

**special lengths on request

SYSTEM

Top Line Ceiling Puk heads



Die Puk und Puk Maxx Leuchtenköpfe können in Halogen oder LED zur Bestückung gewählt werden. CHECK I ist ein einfacher Leuchtenkopf, CHECK II ein doppelter Leuchtenkopf und sorgt für noch mehr Licht im Raum.

Standardmodelle auf Seite 218 - 223.



For equipment the Puk and Puk Maxx heads can be chosen in LED or Halogen. CHECK I means a single head, while CHECK II is a double head for much more illumination.

Standard models on page 218 - 223.





Puk Mini Check I LED  2 x 8W ~1.200lm ~2.700k	Puk Check I G9 Fassung 	Gehäuse body
8-160811-LED 8-160812-LED 8-160813-LED	8-160811-H 8-160812-H 8-160813-H	chrome matt chrome nickel matt







Puk Maxx Check I LED  2 x 12W ~1.800lm ~2.700k	Puk Maxx Check I G9 Fassung 	Gehäuse body
8-360811-LED 8-360812-LED 8-360813-LED	8-360811-H 8-360812-H 8-360813-H	chrome matt chrome nickel matt



Puk Mini Check II LED  4 x 8W ~2.400lm ~2.700k	Puk Check II G9 Fassung 	Gehäuse body
8-1609201-LED 8-1609202-LED 8-1609203-LED	8-1609201-H 8-1609202-H 8-1609203-H	chrome matt chrome nickel matt



Puk Maxx Check II LED  4 x 12W ~3.600lm ~2.700k	Puk Maxx Check II G9 Fassung 	Gehäuse body
8-3609201-LED 8-3609202-LED 8-3609203-LED	8-3609201-H 8-3609202-H 8-3609203-H	chrome matt chrome nickel matt

 G9 max. 33W, optional LED Retrofit | Leuchtmittelempfehlung: LED max. 3W/300lm/2.700K/dimmbar  Art Nr. 8-205
G9 max. 33W, LED Retrofit optional | bulb recommendation: LED max. 3W/300Lm/2.700K/dimmable  Item No. 8-205

Bei den Puk Leuchten werden zu dem Leuchtenkopf die Gläser/Linsen und optional die Farbfilter separat dazubestellt! Artikelnummern entnehmen Sie bitte den Equipment-Tabellen auf der Einkaufseite.

With the Puk lamps, the glasses, lenses and optional the color filters are ordered separately. Please check the equipment lists on the fold-in page for item numbers.



Top Line Ceiling Puk heads

Die Puk und Puk Maxx Leuchtenköpfe können in Halogen oder LED zur Bestückung gewählt werden. Der Puk Check Turn Leuchtenkopf mit Gelenk erlaubt eine individuelle Einstellung der Beleuchtung.

Standardmodelle auf Seite 218 - 223.

For equipment the Puk and Puk Maxx heads can be chosen in LED or Halogen. By choosing the Puk Turn Head with the joint nearly every individual requirement can be fulfilled.

Standard models on page 218 - 223.



up- & downlight

Puk Mini Turn
Check
LED **G**
2 x 8W
~1.200lm ~2.700k

Puk Turn
Check
G9 Fassung

Gehäuse
body

8-1628001-LED
8-1628002-LED
8-1628003-LED

8-1628001-H
8-1628002-H
8-1628003-H

chrome matt
chrome
nickel matt

up- & downlight

Puk Maxx Turn
Check
LED **G**
2 x 12W
~1.800lm ~2.700k

Puk Maxx Turn
Check
G9 Fassung

Gehäuse
body

8-3628001-LED
8-3628002-LED
8-3628003-LED

8-3628001-H
8-3628002-H
8-3628003-H

chrome matt
chrome
nickel matt

downlight

Puk Mini Turn
Check
LED **G**
1 x 8W
~600lm ~2.700k

Puk Turn
Check
G9 Fassung

Gehäuse
body

8-1638001-LED
8-1638002-LED
8-1638003-LED

8-1638001-H
8-1638002-H
8-1638003-H

chrome matt
chrome
nickel matt

downlight

Puk Maxx Turn
Check
LED **G**
1 x 12W
~900lm ~2.700k

Puk Maxx Turn
Check
G9 Fassung

Gehäuse
body

8-3638001-LED
8-3638002-LED
8-3638003-LED

8-3638001-H
8-3638002-H
8-3638003-H

chrome matt
chrome
nickel matt

G9 max. 33W, optional LED Retrofit
G9 max. 33W, LED Retrofit optional

Leuchtmittelpfehlung: LED max. 3W/300lm/2.700K/dimmbar **G** Art Nr. 8-205
bulb recommendation: LED max. 3W/300Lm/2.700K/dimmable **G** Item No. 8-205

Bei den Puk Leuchten werden zu dem Leuchtenkopf die Gläser/Linsen und optional die Farbfilter separat dazubestellt! Artikelnummern entnehmen Sie bitte den Equipment-Tabellen auf der Einklappseite.

With the Puk lamps, the glasses, lenses and optional the color filters are ordered separately. Please check the equipment lists on the fold-in page for item numbers.

Top Line Ceiling Puk heads

Die Puk und Puk Maxx Stableuchten Side als Single oder Twin setzen Akzente und konzentrieren Licht, wenn man sie an den wichtigen Stellen ins System einbindet. Auch hier stehen LED Power oder Halogen zur Wahl. Die Armlänge ist 200 mm. Standardmodelle auf Seite 218 - 223.

The Puk and Puk Maxx Side luminaires as single or twin version, provide accents and concentrated light, if they are integrated into the system at important areas. Here, as well, there is a choice of LED Power or halogen. The arm length is 200 mm. Standard models on page 218 - 223.



Puk Mini Side Single Check LED G 2 x 8W ~1.200lm ~2.700k	Puk Side Single Check G9 Fassung	Armlänge arm length	Gehäuse body
8-160831-LED	8-160831-H	200 mm	chrome matt
8-160832-LED	8-160832-H	200 mm	chrome
8-160833-LED	8-160833-H	200 mm	nickel matt



Puk Maxx Side Single Check LED G 2 x 12W ~1.800lm ~2.700k	Puk Maxx Side Single Check G9 Fassung	Armlänge arm length	Gehäuse body
8-360831-LED	8-360831-H	200 mm	chrome matt
8-360832-LED	8-360832-H	200 mm	chrome
8-360833-LED	8-360833-H	200 mm	nickel matt



Puk Mini Side Twin Check LED G 4 x 8W ~2.400lm ~2.700k	Puk Side Twin Check G9 Fassung	Armlänge arm length	Gehäuse body
8-1608511-LED	8-1608511-H	200 mm	chrome matt
8-1608512-LED	8-1608512-H	200 mm	chrome
8-1608513-LED	8-1608513-H	200 mm	nickel matt



Puk Maxx Side Twin Check LED G 4 x 12W ~3.600lm ~2.700k	Puk Maxx Side Twin Check G9 Fassung	Armlänge arm length	Gehäuse body
8-3608511-LED	8-3608511-H	200 mm	chrome matt
8-3608512-LED	8-3608512-H	200 mm	chrome
8-3608513-LED	8-3608513-H	200 mm	nickel matt

G9 max. 33W, optional LED Retrofit | Leuchtmittelpfehlung: LED max. 3W/300lm/2.700K/dimmbar **G** Art Nr. 8-205
 G9 max. 33W, LED Retrofit optional | bulb recommendation: LED max. 3W/300Lm/2.700K/dimmable **G** Item No. 8-205

Bei den Puk Leuchten werden zu dem Leuchtenkopf die Gläser/Linsen und optional die Farbfilter separat dazubestellt! Artikelnummern entnehmen Sie bitte den Equipment-Tabellen auf der Einklappseite.

With the Puk lamps, the glasses, lenses and optional the color filters are ordered separately. Please check the equipment lists on the fold-in page for item numbers.



Top Line Ceiling Puk pendant

Die bewährten Pendelleuchten in Verbindung mit dem System bieten hier noch mehr Varianz. Natürlich in LED Power oder Halogen. Die Seillänge ist 1.300 mm.

More variability with our proved pendant lights in LED or Halogen. The length of the rope is 1.300 mm.

Standardmodelle auf Seite 218 - 223.

Standard models on page 218 - 223.



Puk Mini Long One Check LED G 1 x 8W ~600lm ~2.700k	Puk Long One Check G9 Fassung	Seillänge rope length	Gehäuse body
8-2008001-1-LED	8-2008001-1-H	1.300 mm	chrome matt
8-2008002-1-LED	8-2008002-1-H	1.300 mm	chrome
8-2008003-1-LED	8-2008003-1-H	1.300 mm	nickel matt

Puk Maxx Long One Check LED G 1 x 12W ~900lm ~2.700k	Puk Maxx Long One Check G9 Fassung	Seillänge rope length	Gehäuse body
8-4008001-1-LED	8-4008001-1-H	1.300 mm	chrome matt
8-4008002-1-LED	8-4008002-1-H	1.300 mm	chrome
8-4008003-1-LED	8-4008003-1-H	1.300 mm	nickel matt

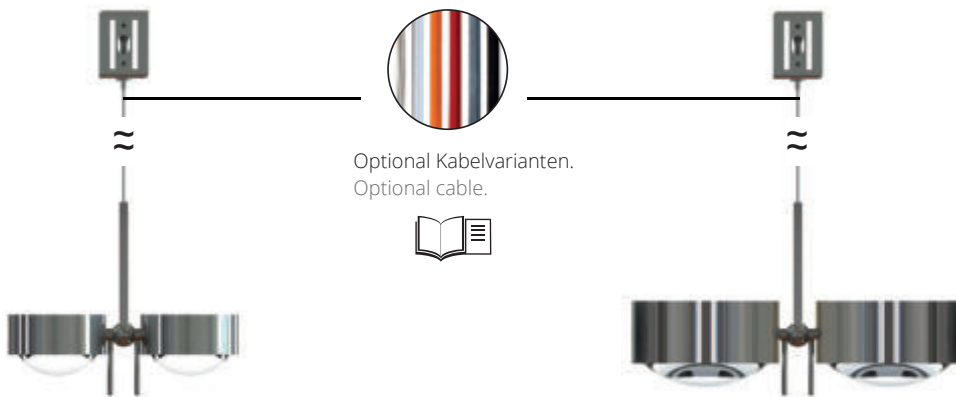

Puk Mini Long Double Check LED G 4 x 8W ~2.400lm ~2.700k	Puk Long Double Check G9 Fassung	Seillänge rope length	Gehäuse body
8-2008001-2-LED	8-2008001-2-H	1.300 mm	chrome matt
8-2008002-2-LED	8-2008002-2-H	1.300 mm	chrome
8-2008003-2-LED	8-2008003-2-H	1.300 mm	nickel matt

Puk Maxx Long Double Check LED G 4 x 12W ~3.600lm ~2.700k	Puk Maxx Long Double Check G9 Fassung	Seillänge rope length	Gehäuse body
8-4008001-2-LED	8-4008001-2-H	1.300 mm	chrome matt
8-4008002-2-LED	8-4008002-2-H	1.300 mm	chrome
8-4008003-2-LED	8-4008003-2-H	1.300 mm	nickel matt

G9 max. 33W, optional LED Retrofit
 Leuchtmittelempfehlung: LED max. 3W/300lm/2.700K/dimmbar **G** Art Nr. 8-205
 G9 max. 33W, LED Retrofit optional
 bulb recommendation: LED max. 3W/300Lm/2.700K/dimmable **G** Item No. 8-205

Bei den Puk Leuchten werden zu dem Leuchtenkopf die Gläser/Linsen und optional die Farbfilter separat dazubestellt! Artikelnummern entnehmen Sie bitte den Equipment-Tabellen auf der Einklappseite.

With the Puk lamps, the glasses, lenses and optional the color filters are ordered separately. Please check the equipment lists on the fold-in page for item numbers.





Top Line Ceiling Sun pendant

Die Leuchten Sun in ihren drei Größen erweitern das Puk Pendelsystem. Übrigens lassen sich auch systemfremde Pendelleuchten integrieren. Die Seillänge beträgt 1.200 mm.

The lamps Sun with its three sizes expand our Puk pendant system. Furthermore even non-system lights can be integrated. The length of the rope is 1.200 mm.

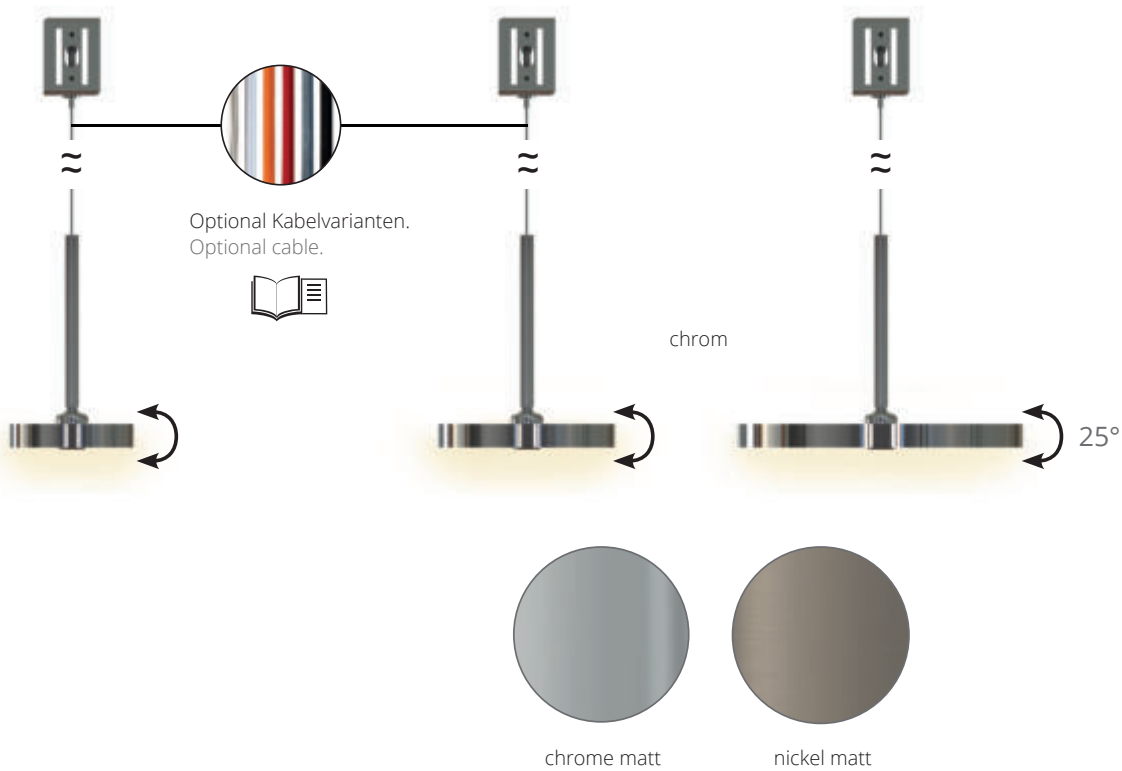

SYSTEM

Sun Swing Down Check ø 90 mm LED G 8W ~600lm ~2.700k	Sun Swing Down Check ø 130 mm LED G 12W ~900lm ~2.700k	Sun Swing Down Check ø 210 mm LED G 16W ~1.200lm ~2.700k	Seillänge rope length	Gehäuse body
8-503289011-LED	8-5032813011-LED	8-5032821011-LED	1.200 mm	chrome matt
8-503289012-LED	8-5032813012-LED	8-5032821012-LED	1.200 mm	chrome
8-503289013-LED	8-5032813013-LED	8-5032821013-LED	1.200 mm	nickel matt

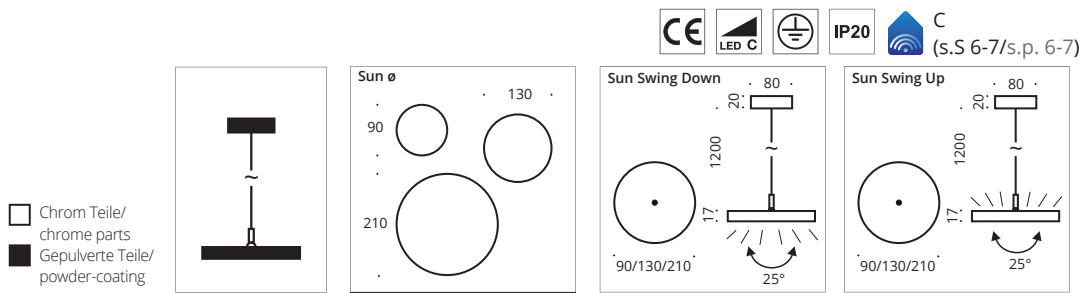

Top Line Ceiling Pela pendant



Die Leuchten Pela und Pela Quadro erweitern das Puk Pendelsystem. Übrigens lassen sich auch systemfremde Pendelleuchten integrieren. Die Seillänge beträgt 1.200 mm.





The lamps Pela and Pela Quadro expand our Puk pendant system. Furthermore even non-system lights can be integrated. The length of the rope is 1.200 mm.





Pela Check L = 1.200 mm E27, ohne LM E27, no lamp	Pela Quadro Check L = 1.200 mm E27, ohne LM E27, no lamp	Gehäuse body
8-5007651-H 8-5007652-H	8-5008651-H 8-5008652-H	chrome nickel matt

E27 max. 42W, optional LED Retrofit
E27 max. 42W, LED Retrofit optional

Leuchtmittelempfehlung: LED max. 9W/800lm/2.700K  Art. Nr. 8-309
bulb recommendation: LED max. 9W/800Lm/2.700K  Item No. 8-309

65
 65
 65
 180
 1200

 C (s.S 6-7/s.p. 6-7)



Top Line Ceiling Look at me pendant

Die Leuchte »Look at me« erweitern das Puk Pendelsystem. Übrigens lassen sich auch systemfremde Pendelleuchten integrieren. Die Seillänge beträgt 1.200 mm.

The lamp »Look at me« expand our Puk pendant system. Furthermore even non-system lights can be integrated. The length of the rope is 1.200 mm.

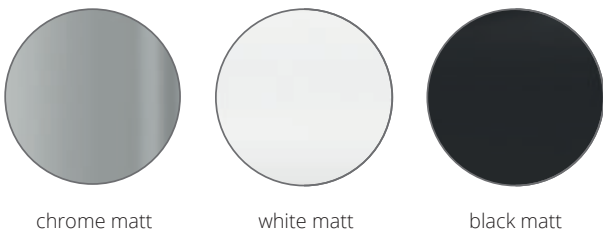

chrome matt

white matt

black matt







Optional Kabelvarianten.
Optional cable.



chrome

SYSTEM

Look at me Check LED L = 1.200 mm G 8W ~600lm ~2.800k	Gehäuse body
8-50911-1-LED	chrome matt
8-50911-2-LED	chrome
8-50911-2-LED-22	white matt
8-50911-2-LED-02	black matt
Separat dazu zu bestellen. For separat order.	
2-9126	lens clear
2-9126-S	lens satined

Look at me

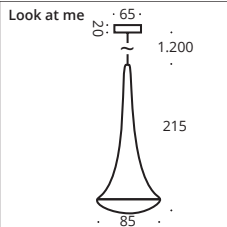

IP20: ABC (s.S 6-7/s.p. 6-7)
IP44: BC (s.S 6-7/s.p. 6-7)





Top Line Gallery

Optimale Beleuchtung für Wände und Bilder. Mit dem Galeriesystem bleibt nichts im Dunkeln. Als Wandabhängung über alle Strecken und Ecken nutzbar. Zur Bestückung können die Puk oder Puk Maxx Leuchtenköpfe in LED oder Halogen gewählt werden. Hier nur einige Konfigurationsbeispiele.

Optimized illumination for walls and pictures. The Puk System Gallery illuminates everything. As wall-fixing for all corners and distances. For equipment the Puk and Puk Maxx heads are available. This page shows a few configuration examples only.

Beispiele Systemführung & Konfiguration

Rail system & configuration examples

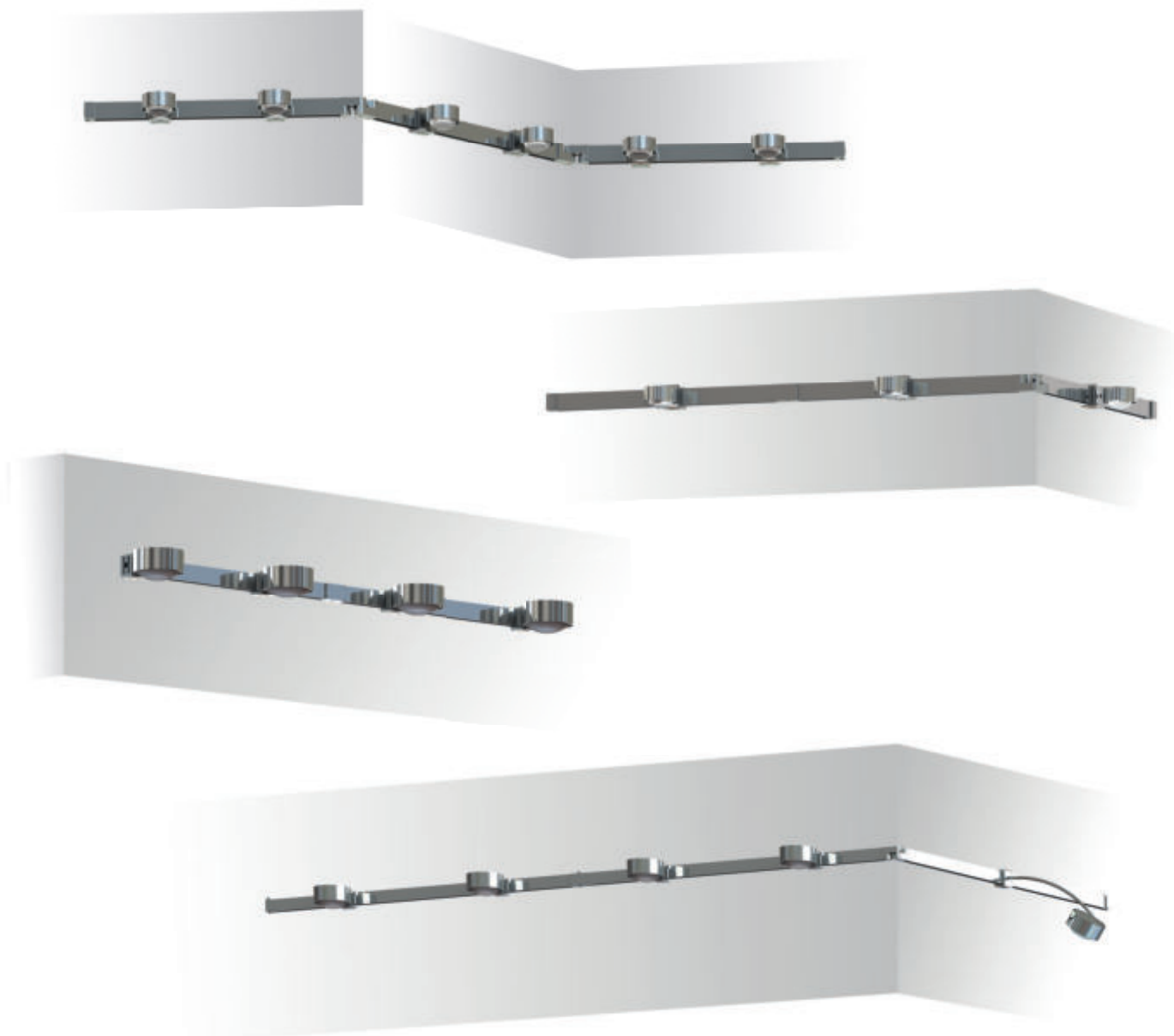

SYSTEM



C (s.S 6-7/s.p. 6-7)

Bei den Puk Leuchten werden zu dem Leuchtenkopf die Gläser/Linsen und optional die Farbfilter separat dazubestellt! Artikelnummern entnehmen Sie bitte den Equipment-Tabellen auf der Einklappseite.

With the Puk lamps, the glasses, lenses and optional the color filters are ordered separately. Please check the equipment lists on the fold-in page for item numbers.

Top Line Gallery components

SCHIENEN (kürzbar**) / RAILS (can be shortened**)

HALTER HALTER / MOUNTING SUPPORT

Schiene gerade
rail straight

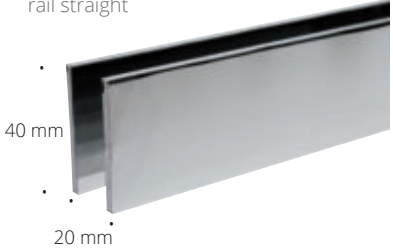

40 mm
20 mm

Doppelschiene Alu/double rail 

Maße/dimensions: B 20 x H 40 mm

Farbe/color	L (mm)	Art.-Nr. item-no.
chrome matt	600	8-070601
chrome	600	8-070602
nickel matt	600	8-070603
chrome matt	1.200	8-0701201
chrome	1.200	8-0701202
nickel matt	1.200	8-0701203

Schienshalter Wandbefestigung
rail support wall mounting



Material: Metall/material: metal

Maße/dimensions: B 50 x H 55 x T 40 mm

Farbe/color	Art.-Nr. item-no.
chrome matt	8-0721
chrome	8-0722
nickel matt	8-0723

Endstück (Wandbefestigungsset muss separat dazu bestellt werden)
railendpiece (wall mounting set is ordered separately)



Material: Metall/material: metal

Maße/dimensions: B 30 x H 40 x T 25 mm

Farbe/color	Art.-Nr. item-no.
chrome matt	8-0841
chrome	8-0842
nickel matt	8-0843

Fertig gesägt nach Maß und freigegebener Zeichnung **Art.-Nr. 8-0990**

Customized length (after released drawing) **Item no. 8-0990**

VERBINDER / CONNECTOR

ZUBEHÖR / EQUIPMENT

Verbinder gerade (Wandbefestigungsset muss separat dazu bestellt werden)
straight connector (wall mounting set is ordered separately)



Material: Metall/material: metal

Maße/dimensions: B 60 x H 40 x T 30 mm

Farbe/color	Art.-Nr. item-no.
chrome matt	8-0811
chrome	8-0812
nickel matt	8-0813

Gelenkverbinder für Winkelmontage
articulated connector for bracket mounting



Material: Metall/material: metal

Maße/dimensions: B 90 x H 40 x T 30 mm

Winkel/angle: max. 125°

Farbe/color	Art.-Nr. item-no.
chrome matt	8-0731
chrome	8-0732
nickel matt	8-0733

Wandbefestigungsset**
wall mounting set**



**Für Verbinder gerade und Endstück
**for straight connector and railendpiece

Material: Metall/material: metal

Maße/dimensions: B 20 x H 40 x T 32 mm

Farbe/color	Art.-Nr. item-no.
steel	8-078



Top Line Gallery components

EINSPEISUNG / FEED-IN

Wand-, Deckeneinspeisung
feed-in for wall and ceiling



Material: Metall/material: metal

Maße/dimensions: B 65 x H 65 mm

Farbe/color	L mm**	Design	Art.-Nr. item-no.
chrome matt	1.200	□	8-0761
chrome	1.200	□	8-0762
nickel matt	1.200	□	8-0763
chrome matt	1.200	○	8-0771
chrome	1.200	○	8-0772
nickel matt	1.200	○	8-0773

**Sonderlängen auf Anfrage

**special lengths on request

ZUBEHÖR / EQUIPMENT

2 Bilderhalter**
2 picture holder**



Montage auf der wandseitigen Schiene
Assembly on the wall side rail

Material: Metall/material: metal

Maße/dimensions: B 20 x H 40 x T 5 mm

Farbe/color	Art.-Nr. item-no.
nickel	8-0753

**Lieferung ohne Seil zur Abhängung

**delivery without wire for suspension

Deco-Knopf decorative knob

Bei Leuchtkopfbestellung
Deco-Knopf separat dazu zu
bestellen.

Decorative knob for
illuminated heads for
separat order.



Art. Nr. item no.	Farbe color
8-07501	chrome matt
8-07502	chrome
8-07503	nickel matt





Top Line Gallery Puk heads

Die Puk und Puk Maxx Leuchtenköpfe können in Halogen oder LED zur Bestückung gewählt werden. CHECK I ist ein einfacher Leuchtenkopf. Puk Rainbow mit gebogenem Stab setzt Ihre Bilder optimal in Szene.

For equipment the Puk and Puk Maxx heads are available. CHECK I is a single head. The bend tube Puk Rainbow sets the scene effectively.



Puk Mini
Check I
LED **G**
2 x 8W
~1.200lm ~2.700k

Puk Mini
Check I
G9 Fassung



Gehäuse
body

8-160811-LED
8-160812-LED
8-160813-LED

8-160811-H
8-160812-H
8-160813-H

chrome matt
chrome
nickel matt



Puk Maxx
Check I
LED **G**
2 x 12W
~1.800lm ~2.700k

Puk Maxx
Check I
G9 Fassung



Gehäuse
body

8-360811-LED
8-360812-LED
8-360813-LED

8-360811-H
8-360812-H
8-360813-H

chrome matt
chrome
nickel matt

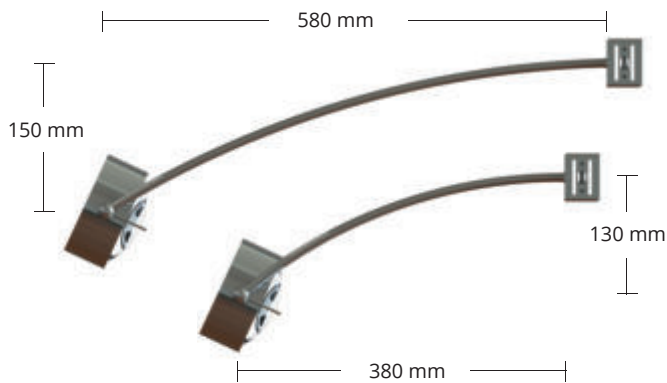

Puk Rainbow
400 mm G9

Puk Rainbow
600 mm G9

Gehäuse
body

8-1708401-H
8-1708402-H
8-1708403-H

8-1708601-H
8-1708602-H
8-1708603-H

chrome matt
chrome
nickel matt

G9 max. 33W, optional LED Retrofit
 G9 max. 33W, LED Retrofit optional

Leuchtmittelempfehlung: LED max. 3W/300lm/2.700K/dimmbar

G Art Nr. 8-205
 bulb recommendation: LED max. 3W/300Lm/2.700K/dimmable
 Item No. 8-205

Puk Rainbow
400 mm
LED 2 x 8W
G
~1.200lm ~2.700k

Puk Rainbow
400 mm
LED 1 x 8W
G
~600lm ~2.700k

Gehäuse
body

8-1708401-LED
8-1708402-LED
8-1708403-LED

8-1708411-LED
8-1708412-LED
8-1708413-LED

chrome matt
chrome
nickel matt

Puk Rainbow
600 mm
LED 2 x 8W
G
~1.200lm ~2.700k

Puk Rainbow
600 mm
LED 1 x 8W
G
~600lm ~2.700k

Gehäuse
body

8-1708601-LED
8-1708602-LED
8-1708603-LED

8-1708611-LED
8-1708612-LED
8-1708613-LED

chrome matt
chrome
nickel matt

Bei den Puk Leuchten werden zu dem Leuchtenkopf die Gläser/Linsen und optional die Farbfilter separat dazubestellt! Artikelnummern entnehmen Sie bitte den Equipment-Tabellen auf der Einklappseite.

With the Puk lamps, the glasses, lenses and optional the color filters are ordered separately. Please check the equipment lists on the fold-in page for item numbers.



Top Line System Crown



Top Line Crown

Ein Kronleuchter nach Maß und nach Ihren Anforderungen. Kreieren Sie sich die Puk System Crown nach Ihren Wünschen und Bedürfnissen. Als LED oder Halogen Variante mit den Leuchtenköpfen der Puk oder Puk Maxx Serie. Hier nur einige Konfigurationsbeispiele.

A customized chandelier for every requirement. Create your own chandelier according to your needs. The Crown is equipped with the Puk and Puk Maxx heads in LED or Halogen. Here are just a few configuration examples.

Beispiele Systemführung & Konfiguration

Rail system & configuration examples

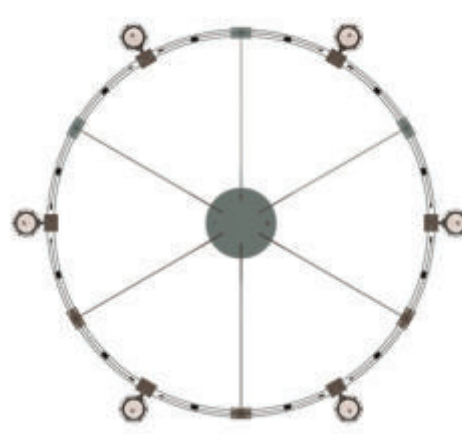
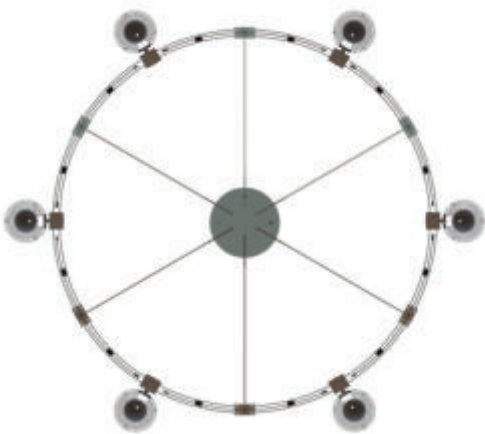
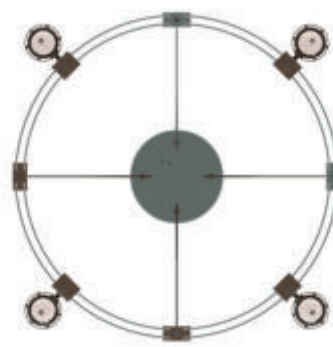
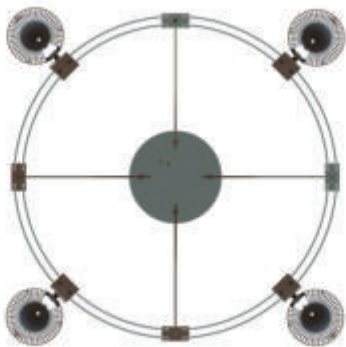

SYSTEM

Bei den Puk Leuchten werden zu dem Leuchtenkopf die Gläser/Linsen und optional die Farbfilter separat dazubestellt! Artikelnummern entnehmen Sie bitte den Equipment-Tabellen auf der Einklappseite.

With the Puk lamps, the glasses, lenses and optional the color filters are ordered separately. Please check the equipment lists on the fold-in page for item numbers.



C (s.S 6-7/s.p. 6-7)





Top Line Crown Configuration

D = geplanter Durchmesser der Crown
V = Anzahl der benötigten gebogenen Verbinder

D = planned diameter of the Crown
V = number of required bent connectors

Standardmodelle auf Seite 210 - 217.

Standard models on page 210 - 217.

D \ V	3	4	5	6	7	8	9	10	11	12	14	16
600 mm	✓											
800 mm		✓										
1.200 mm				✓								
1.500 mm				✓								
1.800 mm				✓								
2.500 mm						✓						
3.000 mm						✓						
3.500 mm								✓				
4.000 mm										✓		
4.500 mm											✓	
5.000 mm												✓

SYSTEM

Regulär wird empfohlen, an den Verbindern/Endstücken abzuhängen. Aus optischen oder technischen Gründen kann aber auch auf andere Möglichkeiten, wie die Tabelle zeigt, zurückgegriffen werden. Die empfohlene Anzahl von Verbindern in der Tabelle entspricht auch den benötigten Seil- oder Rohrabhängungen.

We recommend to hang up the system on the connectors or end pieces. For optical or technical reasons the above listed possibilities can be taken in consideration as well.

Top Line Crown components

Standardmodelle auf Seite 210 - 217. Standard models on page 210 - 217.

SCHIENEN (kürzbar) / RAILS (can be shortened)

Schiene gebogen
rail bent

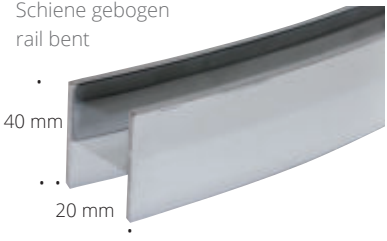

40 mm
20 mm

Doppelschiene Alu/double rail
Maße/dimensions: B 20 x H 40 mm, r = ... (> 300mm)

Farbe/color	L (mm)	Art.-Nr. item-no.
chrome matt	300	8-060301
chrome	300	8-060302
nickel matt	300	8-060303
chrome matt	500	8-060501
chrome	500	8-060502
nickel matt	500	8-060503
chrome matt	1.200	8-0601201
chrome	1.200	8-0601202
nickel matt	1.200	8-0601203

VERBINDER / CONNECTOR

Verbinder gebogen, Abhängung Rohr/Seil
bent connector, suspension tube/wire



Material: Metall/material: metal
Maße/dimensions: B 60 x H 40 x T 30 mm

Farbe/color	Art.-Nr. item-no.
chrome matt	8-0611
chrome	8-0612
nickel matt	8-0613

HALTER / MOUNTING SUPPORT

Halter für freie Pendel Montage,
Abhängung Rohr/Seil
mounting support for pendula mounting,
suspension tube/wire



Material: Metall/material: metal
Anschluss: M10 x 1
Maße/dimensions: B 50 x H 55 x T 40 mm

Farbe/color	Art.-Nr. item-no.
chrome matt	8-0621
chrome	8-0622
nickel matt	8-0623

Verbindungskabel, Elektroklemmen und Kabelarretierung liegen ausreichend bei. Connecting cables, luster terminals and cable locks are enclosed.

ABHÄNGUNG / SUSPENSION

Rohr Abhängung
tube suspension



Material: Metall/material: metal
Maße/dimensions: H 20 x ø 40 mm

Farbe/color	L mm**	Art.-Nr. item-no.
chrome matt	100	8-06411
chrome	100	8-06412
nickel matt	100	8-06413
chrome matt	200	8-06421
chrome	200	8-06422
nickel matt	200	8-06423
chrome matt	300	8-06431
chrome	300	8-06432
nickel matt	300	8-06433

Seil Abhängung
wire suspension



Material: Metall/material: metal, max. 29 kg
Maße/dimensions: H 18 x ø 15 mm

Farbe/color	Seil/Rope L mm**	Art.-Nr. item-no.
chrome matt	2.000	8-066120
chrome	2.000	8-066220
nickel matt	2.000	8-066320
chrome matt	5.000	8-066150
chrome	5.000	8-066250
nickel matt	5.000	8-066350

EINSPEISUNG / FEED-IN

Baldachin mit Abhängung für bis
ø = < 180 cm (s. Crown Configuration)
baldachin with suspension for up to
ø = < 180 cm (s. Crown Configuration)



Anwendbar für 3 Etagen Crown
Seilabhängung + Einspeisung sind separat
zu bestellen
applicable for 3-level chandelier
wire suspension + feed in for separat order
Material: Metall/material: metal
Maße/dimensions: ø 200 mm

Farbe/color	Art.-Nr. item-no.
chrome matt	8-0631
chrome	8-0632
nickel matt	8-0633

**Sonderlängen auf Anfrage
**special lengths on request

**Sonderlängen auf Anfrage
**special lengths on request



Top Line Crown components

Standardmodelle auf Seite 210 - 217. Standard models on page 210 - 217.

EINSPEISUNG / FEED-IN

Einspeisung mit Abhängung
feed-in with wire suspension



Material: Metall/material: metal

Maße/dimensions: B 65 x H 65 mm

Farbe/color	L mm**	Design	Art.-Nr. item-no.
chrome matt	2.000	<input type="checkbox"/>	8-0661
chrome	2.000	<input type="checkbox"/>	8-0662
nickel matt	2.000	<input type="checkbox"/>	8-0663
chrome matt	2.000	<input type="radio"/>	8-0671
chrome	2.000	<input type="radio"/>	8-0672
nickel matt	2.000	<input type="radio"/>	8-0673

Einspeisung ohne Abhängung
feed-in without wire suspension



Material: Metall/material: metal

Maße/dimensions: B 65 x H 65 mm

Farbe/color	L mm**	Design	Art.-Nr. item-no.
chrome matt	2.000	<input type="checkbox"/>	8-0681
chrome	2.000	<input type="checkbox"/>	8-0682
nickel matt	2.000	<input type="checkbox"/>	8-0683
chrome matt	2.000	<input type="radio"/>	8-0691
chrome	2.000	<input type="radio"/>	8-0692
nickel matt	2.000	<input type="radio"/>	8-0693

**Sonderlängen auf Anfrage **special lengths on request **Sonderlängen auf Anfrage **special lengths on request

ABHÄNGUNG / SUSPENSION

Sammelabhängung für hohe Decken – auf Anfrage
collected suspension for high ceiling – on request



Anwendbar für bis zu 3 Etagen Crown
Applicable for up to 3-level chandelier

Material: Metall/material: metal

Maße/dimensions: ø 200 mm

Farbe/color	Art.-Nr. item-no.
chrome matt	8-06531
chrome	8-06532
nickel matt	8-06533

EINSPEISUNG / FEED-IN

Seil Abhängung für Baldachin
(8-0631-33 s. links)
wire suspension for baldachin
(8-0631-33 s. left)



Material: Metall/material: metal
kürzbar/can be shortened

Farbe/color Länge/length	Art.-Nr. item-no.
nickel L = 2.000 mm**	8-0992
nickel L = 5.000 mm**	8-0991

Einspeisung Kabel, 3 pol. transparent
feed-in cable, 3-pole cable transparent



Pro Ring 1 Einspeisung/ 1 feed-in per ring
kürzbar/can be shortened

Farbe/color Länge/length	Art.-Nr. item-no.
transp. L = 2.000 mm**	8-0993
transp. L = 5.000 mm**	8-0994

**Sonderlängen auf Anfrage **special lengths on request **Sonderlängen auf Anfrage **special lengths on request

ZUBEHÖR / EQUIPMENT

Deco-Knopf decorative knob

Bei Leuchtkopfbestellung
Deco-Knopf separat dazu zu
bestellen.

Decorative knob for
illuminated heads for
separat order.



Art. Nr. item no.	Farbe color
8-07501	chrome matt
8-07502	chrome
8-07503	nickel matt

Top Line Crown Puk heads



Die Puk und Puk Maxx Leuchtenköpfe können in Halogen oder LED zur Bestückung gewählt werden. CHECK I ist ein einfacher Leuchtenkopf, CHECK II ein doppelter Leuchtenkopf und sorgt für noch mehr Licht im Raum.

For equipment the Puk and Puk Maxx heads can be chosen in LED or Halogen. CHECK I means a single head, while CHECK II is a double head for much more illumination.



Standardmodelle auf Seite 210 - 217.

Standard models on page 210 - 217.





Puk Mini Check I LED  2 x 8W ~1.200lm ~2.700k	Puk Check I G9 Fassung 	Gehäuse body
8-160811-LED 8-160812-LED 8-160813-LED	8-160811-H 8-160812-H 8-160813-H	chrome matt chrome nickel matt







Puk Maxx Check I LED  2 x 12W ~1.800lm ~2.700k	Puk Maxx Check I G9 Fassung 	Gehäuse body
8-360811-LED 8-360812-LED 8-360813-LED	8-360811-H 8-360812-H 8-360813-H	chrome matt chrome nickel matt



Puk Mini Check II LED  4 x 8W ~2.400lm ~2.700k	Puk Check II G9 Fassung 	Gehäuse body
8-1609201-LED 8-1609202-LED 8-1609203-LED	8-1609201-H 8-1609202-H 8-1609203-H	chrome matt chrome nickel matt



Puk Maxx Check II LED  4 x 12W ~3.600lm ~2.700k	Puk Maxx Check II G9 Fassung 	Gehäuse body
8-3609201-LED 8-3609202-LED 8-3609203-LED	8-3609201-H 8-3609202-H 8-3609203-H	chrome matt chrome nickel matt

 G9 max. 33W, optional LED Retrofit | Leuchtmittelempfehlung: LED max. 3W/300lm/2.700K/dimmbar  Art Nr. 8-205
G9 max. 33W, LED Retrofit optional | bulb recommendation: LED max. 3W/300Lm/2.700K/dimmable  Item No. 8-205

Bei den Puk Leuchten werden zu dem Leuchtenkopf die Gläser/Linsen und optional die Farbfilter separat dazubestellt! Artikelnummern entnehmen Sie bitte den Equipment-Tabellen auf der Einklappseite.

With the Puk lamps, the glasses, lenses and optional the color filters are ordered separately. Please check the equipment lists on the fold-in page for item numbers.



Top Line Crown Puk heads

Die Puk und Puk Maxx Leuchtenköpfe können in Halogen oder LED zur Bestückung gewählt werden. Der Puk Check Turn Leuchtenkopf mit Gelenk erlaubt eine individuelle Einstellung der Beleuchtung.

For equipment the Puk and Puk Maxx heads can be chosen in LED or Halogen. By choosing the Puk Turn Head with the joint nearly every individual requirement can be fulfilled.

Standardmodelle auf Seite 210 - 217.

Standard models on page 210 - 217.



up- & downlight

Puk Mini Turn Check LED G 2 x 8W ~1.200lm ~2.700k	Puk Turn Check G9 Fassung	Gehäuse body
8-1628001-LED 8-1628002-LED 8-1628003-LED	8-1628001-H 8-1628002-H 8-1628003-H	chrome matt chrome nickel matt

up- & downlight

Puk Maxx Turn Check LED G 2 x 12W ~1.800lm ~2.700k	Puk Maxx Turn Check G9 Fassung	Gehäuse body
8-3628001-LED 8-3628002-LED 8-3628003-LED	8-3628001-H 8-3628002-H 8-3628003-H	chrome matt chrome nickel matt

downlight

Puk Mini Turn Check LED G 1 x 8W ~600lm ~2.700k	Puk Turn Check G9 Fassung	Gehäuse body
8-1638001-LED 8-1638002-LED 8-1638003-LED	8-1638001-H 8-1638002-H 8-1638003-H	chrome matt chrome nickel matt

downlight

Puk Maxx Turn Check LED G 1 x 12W ~900lm ~2.700k	Puk Maxx Turn Check G9 Fassung	Gehäuse body
8-3638001-LED 8-3638002-LED 8-3638003-LED	8-3638001-H 8-3638002-H 8-3638003-H	chrome matt chrome nickel matt

G9 max. 33W, optional LED Retrofit | Leuchtmittelempfehlung: LED max. 3W/300lm/2.700K/dimmbar **G** Art Nr. 8-205
 G9 max. 33W, LED Retrofit optional | bulb recommendation: LED max. 3W/300Lm/2.700K/dimmable **G** Item No. 8-205

Bei den Puk Leuchten werden zu dem Leuchtenkopf die Gläser/Linsen und optional die Farbfilter separat dazubestellt! Artikelnummern entnehmen Sie bitte den Equipment-Tabellen auf der Einklappseite.

With the Puk lamps, the glasses, lenses and optional the color filters are ordered separately. Please check the equipment lists on the fold-in page for item numbers.

Top Line Crown Puk heads



Die Puk und Puk Maxx Stableuchten Side als Single oder Twin setzen Akzente und konzentrieren Licht, wenn man sie an den wichtigen Stellen ins System einbindet. Auch hier stehen LED Power oder Halogen zur Wahl. Die Armlänge ist 200 mm.

The Puk and Puk Maxx Side luminaires as single or twin version, provide accents and concentrated light, if they are integrated into the system at important areas. Here, as well, there is a choice of LED Power or halogen. The arm length is 200 mm.



Standardmodelle auf Seite 210 - 217.

Standard models on page 210 - 217.





Puk Mini Side Single Check LED  2 x 8W ~1.200lm ~2.700k	Puk Side Single Check G9 Fassung 	Armlänge arm length	Gehäuse body
8-160831-LED	8-160831-H	200 mm	chrome matt
8-160832-LED	8-160832-H	200 mm	chrome
8-160833-LED	8-160833-H	200 mm	nickel matt







Puk Maxx Side Single Check LED  2 x 12W ~1.800lm ~2.700k	Puk Maxx Side Single Check G9 Fassung 	Armlänge arm length	Gehäuse body
8-360831-LED	8-360831-H	200 mm	chrome matt
8-360832-LED	8-360832-H	200 mm	chrome
8-360833-LED	8-360833-H	200 mm	nickel matt



Puk Mini Side Twin Check LED  4 x 8W ~2.400lm ~2.700k	Puk Side Twin Check G9 Fassung 	Armlänge arm length	Gehäuse body
8-1608511-LED	8-1608511-H	200 mm	chrome matt
8-1608512-LED	8-1608512-H	200 mm	chrome
8-1608513-LED	8-1608513-H	200 mm	nickel matt



Puk Maxx Side Twin Check LED  4 x 12W ~3.600lm ~2.700k	Puk Maxx Side Twin Check G9 Fassung 	Armlänge arm length	Gehäuse body
8-3608511-LED	8-3608511-H	200 mm	chrome matt
8-3608512-LED	8-3608512-H	200 mm	chrome
8-3608513-LED	8-3608513-H	200 mm	nickel matt

 G9 max. 33W, optional LED Retrofit | Leuchtmittelempfehlung: LED max. 3W/300lm/2.700K/dimmbar  Art Nr. 8-205
G9 max. 33W, LED Retrofit optional | bulb recommendation: LED max. 3W/300Lm/2.700K/dimmable  Item No. 8-205

Bei den Puk Leuchten werden zu dem Leuchtenkopf die Gläser/Linsen und optional die Farbfilter separat dazubestellt! Artikelnummern entnehmen Sie bitte den Equipment-Tabellen auf der Einklappseite.

With the Puk lamps, the glasses, lenses and optional the color filters are ordered separately. Please check the equipment lists on the fold-in page for item numbers.



Top Line Crown Puk pendant

Die bewährten Pendelleuchten in Verbindung mit dem System bieten hier noch mehr Varianz. Natürlich in LED Power oder Halogen. Die Seillänge ist 1.300 mm.

More variability with our proved pendant lights in LED or Halogen. The length of the rope is 1.300 mm.

Standardmodelle auf Seite 210 - 217.

Standard models on page 210 - 217.

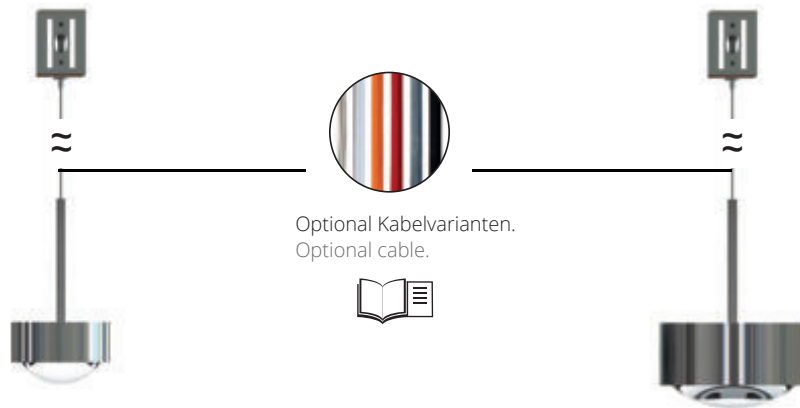

Optional Kabelvarianten.
Optional cable.

Puk Mini Long One Check LED G 1 x 8W ~600lm ~2.700k	Puk Long One Check G9 Fassung	Seillänge rope length 	Gehäuse body
8-2008001-1-LED	8-2008001-1-H	1.300 mm	chrome matt
8-2008002-1-LED	8-2008002-1-H	1.300 mm	chrome
8-2008003-1-LED	8-2008003-1-H	1.300 mm	nickel matt

Puk Maxx Long One Check LED G 1 x 12W ~900lm ~2.700k	Puk Maxx Long One Check G9 Fassung 	Seillänge rope length	Gehäuse body
8-4008001-1-LED	8-4008001-1-H	1.300 mm	chrome matt
8-4008002-1-LED	8-4008002-1-H	1.300 mm	chrome
8-4008003-1-LED	8-4008003-1-H	1.300 mm	nickel matt

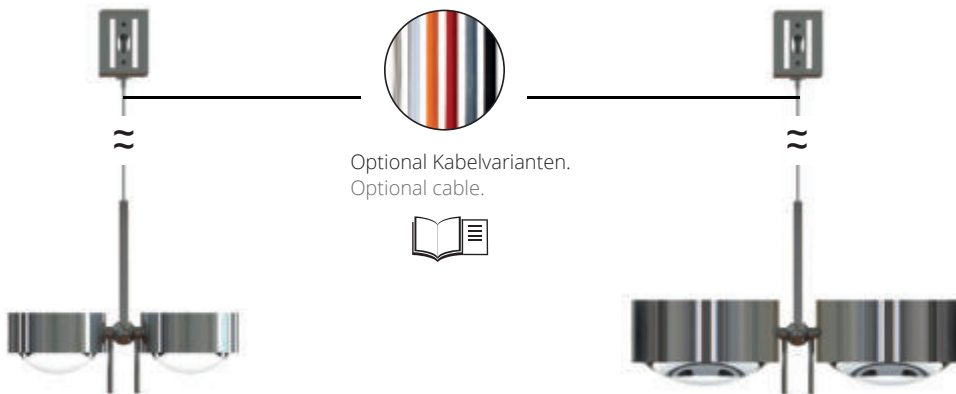

Optional Kabelvarianten.
Optional cable.

Puk Mini Long Double Check LED G 4 x 8W ~2.400lm ~2.700k	Puk Long Double Check G9 Fassung	Seillänge rope length 	Gehäuse body
8-2008001-2-LED	8-2008001-2-H	1.300 mm	chrome matt
8-2008002-2-LED	8-2008002-2-H	1.300 mm	chrome
8-2008003-2-LED	8-2008003-2-H	1.300 mm	nickel matt

Puk Maxx Long Double Check LED G 4 x 12W ~3.600lm ~2.700k	Puk Maxx Long Double Check G9 Fassung 	Seillänge rope length	Gehäuse body
8-4008001-2-LED	8-4008001-2-H	1.300 mm	chrome matt
8-4008002-2-LED	8-4008002-2-H	1.300 mm	chrome
8-4008003-2-LED	8-4008003-2-H	1.300 mm	nickel matt

G9 max. 33W, optional LED Retrofit
 Leuchtmittelempfehlung: LED max. 3W/300lm/2.700K/dimmbar **G** Art Nr. 8-205
 G9 max. 33W, LED Retrofit optional
 bulb recommendation: LED max. 3W/300Lm/2.700K/dimmable **G** Item No. 8-205

Bei den Puk Leuchten werden zu dem Leuchtenkopf die Gläser/Linsen und optional die Farbfilter separat dazubestellt! Artikelnummern entnehmen Sie bitte den Equipment-Tabellen auf der Einklappseite.

With the Puk lamps, the glasses, lenses and optional the color filters are ordered separately. Please check the equipment lists on the fold-in page for item numbers.

SYSTEM





Top Line Elektrifizierung

Top Line Electrification

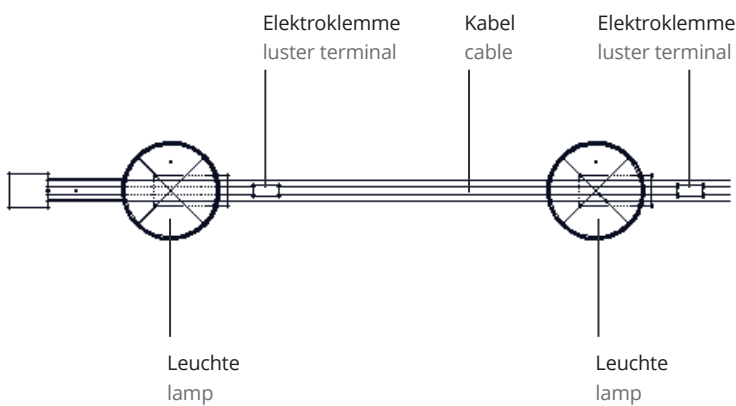

Erdung durch Madenschraube am Kopfhalter

Grounded through headless screw on holder.

1. das Kabel durch Verbindler/Innenschiene.
2. Einspeisung im System anschließbar.

1. cable through the connector/inner rail
2. feed-in connection with the system

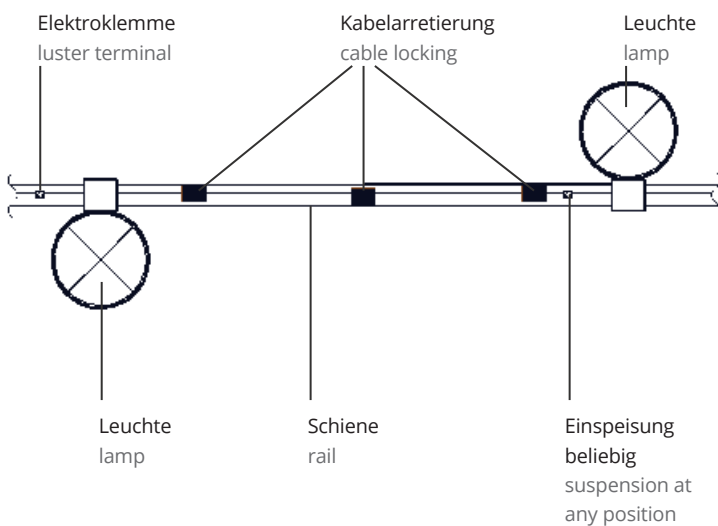

Kabelarretierung einseitig klebbar, versetzt zwischen der Doppelschiene.

One side cable locking in between the double rail.

Verbindungskabel, Elektroklemmen und Kabelarretierungen liegen bei jeder Schiene ausreichend bei.

Connecting cables, luster terminals and cable locks are enclosed.

Systemelektrifizierung nur durch autorisierte Elektrofachkraft.
Kabelenden sind mit Aderendhülsen für 0,75 mm² zu versehen.

Electrification through an authorized electrician only. Wire ends have to be equipped with wire ferrules with 0,75 mm².





Eutrac Puk Mini

Die Puk Mini Köpfe mit passendem Adapter funktionieren mit allen 1- oder 3-Phasen Eutrac Schienen-Modellen. Auf der Seite der Puk-Leuchte finden Sie die Art.-Nr., die Sie mit der Nummer des passenden Eutrac-Adapters von dieser Seite kombinieren.

The Puk Mini heads with matching adapter work with all 1- or 3-phase Eutrac track models. On the page of the Puk luminaire you will find the art. no., which you combine with the number of the matching Eutrac adapter found on this page.



Puk Mini Turn
Seite 29



Puk Mini Eye
Seite 37



Puk Mini Side
Seite 43



Puk Mini Flexlight
Seite 149



Puk Mini Drop
Seite 193



Puk Mini Long One
Seite 187



Puk Mini Long Double
Seite 187

1-Phasen-Adapter



3-Phasen-Adapter



SYSTEM

Adapter Gehäuse
adapter body

Art. Nr. Anhang für 1 Phase
for 1 Phase attach behind
the item no.

Art. Nr. Anhang für 3 Phasen
for 3 Phases attach behind
the item no.

black
white
silver

ci1-sw
ci1-w
ci1-s

ci3-sw
ci3-w
ci3-s





Eutrac Puk Maxx

Die Puk Maxx Köpfe mit passendem Apapter funktionieren mit allen 1- oder 3-Phasen Eutrac Schienen-Modellen. Auf der Seite der Puk-Leuchte finden Sie die Art.-Nr., die Sie mit der Nummer des passenden Eutrac-Adapters von dieser Seite kombinieren.

The Puk Maxx heads with matching adapter work with all 1- or 3-phase Eutrac track models. On the page of the Puk luminaire you will find the art. no., which you combine with the number of the matching Eutrac adapter found on this page.



Puk Maxx Turn
Seite 31



Puk Maxx Eye
Seite 39



Puk Maxx Side
Seite 45



Puk Mini Flexlight
Seite 59



Puk Maxx Drop
Seite 195



Puk Maxx Long One
Seite 189



Puk Maxx Long Double
Seite 189

1-Phasen-Adapter



3-Phasen-Adapter



Adapter Gehäuse
adapter body

Art. Nr. Anhang für 1 Phase
for 1 Phase attach behind
the item no.

Art. Nr. Anhang für 3 Phasen
for 3 Phases attach behind
the item no.

black
white
silver

ci1-sw
ci1-w
ci1-s

ci3-sw
ci3-w
ci3-s





Allround Track ø 120/160/240

Diese dimmbare Leuchte wurde für die Anbringung auf einer 1PH oder 3PH Eurtrac Schiene konstruiert. Mit zwei kardanisch aufeinander abgestimmten Gelenken, lassen sich die LED Leuchtenköpfe um über 360 Grad drehen. Mit drei Leuchtenkopfdurchmessern (ø120mm/8W/920lm, ø160mm/12W/1300lm, ø240mm/16W/1600lm), durchgängig 2700k), lassen sich die Leuchten für viele Anwendungen im Privat- oder Objektbereich einplanen.

This dimmable luminaire is designed to be mounted on a 1PH or PPH Eurtrac track. With two gimbal-mounted joints, the LED luminaire heads can be rotated more than 360°. With three luminaire head diameters (ø120mm/8W/920lm, ø160mm/12W/1300lm, ø240mm/16W/1600lm), the luminaires can be planned for many applications in the residential and public sectors.

Allround in Bewegung (Wandbefestigung) Allround in motion (wall mounting)



Allround in Bewegung (Deckenbefestigung) Allround in motion (ceiling mounting)



SYSTEM

Allround 120 mm ø	Allround 160 mm ø	Allround 240 mm ø	Gehäuse body
LED G 8 Watt, ~2.700k ~920 lm	LED G 12 Watt, ~2.700k ~1.300 lm	LED G 16 Watt, ~2.700k ~1.600 lm	
1 Phase	1 Phase	1 Phase	
● 7-2231211	● 7-2231611	● 7-2232411	chrome matt
● 7-2231212	● 7-2231612	● 7-2232412	chrome
● 7-2231213	● 7-2231613	● 7-2232413	nickel matt
● 7-2231212-22	● 7-2231612-22	● 7-2232412-22	white matt/chr.
● 7-2231212-02	● 7-2231612-02	● 7-2232412-02	black matt/chr
● 7-2231212-23	● 7-2231612-23	● 7-2232412-23	anthracite matt/chr.
3 Phasen	3 Phasen	3 Phasen	
● 7-2241211	● 7-2241611	● 7-2242411	chrome matt
● 7-2241212	● 7-2241612	● 7-2242412	chrome
● 7-2241213	● 7-2241613	● 7-2242413	nickel matt
● 7-2241212-22	● 7-2241612-22	● 7-2242412-22	white matt/chr.
● 7-2241212-02	● 7-2241612-02	● 7-2242412-02	black matt/chr
● 7-2241212-23	● 7-2241612-23	● 7-2242412-23	anthracite matt/chr.

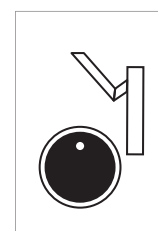
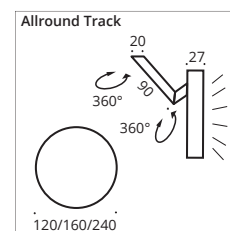
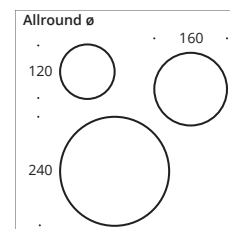

BATH & WELLNESS

1. Spiegelleuchten 352 - 375
2. Lichtspiegel 376 - 419

In den letzten Jahren hat sich das Badezimmer immer mehr zur Wellnessoase entwickelt. Da darf natürlich ein großer, gut ausgeleuchteter Spiegel nicht fehlen. Da die Raumsituationen ebenso verschieden sind, wie die Vorlieben der Menschen, bieten wir eine große Auswahl an Modellen, die mit vielen Extras genau auf Maß gefertigt werden können. Natürlich »Made in Germany«. Kreieren Sie Ihren Traumspiegel mit der optimalen Beleuchtung.

In recent years, the bathroom has increasingly developed into a wellness oasis. Of course, a large, well-lit mirror is an absolute must. As the room situations are as varied as people's preferences, we offer a wide range of models that can be made to measure with many extras. Of course "Made in Germany". Create your dream mirror with the optimal lighting







IP44

Dieses Zeichen finden Sie auf den Seiten unserer Leuchten, die den IP44 Spritzwasserschutz haben.

This symbol indicates that the light has IP protection class IP44.



Schutzbereich für Leuchten und Lichtspiegel

Oft tritt die Frage auf: Welche Schutzklassen gelten im Badezimmer? Wie hoch muss der Schutzgrad der Leuchte sein, die ich im Badezimmer montieren möchte? Um etwas Aufklärung zu schaffen, haben wir auf dieser Doppelseite einmal die verschiedenen Schutzbereiche im Bad aufgezeigt. Die zusätzlichen Erklärungen sollen Ihnen helfen, die richtige Leuchte zu finden.

A frequently asked question is which IP protection class is required. Which class of my lighting fixture is necessary to be allowed to be mounted in the bathroom? To support you with this important question we designed this page which gives you an overview over the different IP protection class sections in bathrooms. The additional explanations should help to find the right lighting fixture.



Wofür braucht man IP44

IP44 steht für Schutz vor Fremdkörpern (>1mm), sowie vor Spritzwasser. Auf unserem Bild sehen Sie, welche Zonen unbedenklich sind und wo man auf ausreichenden IP-Schutz achten sollte.

Zone 1:

Im Bereich der Badewanne und /oder Dusche sind nur Leuchten mit Niedervoltspannung (12V) und hohem Schutzgrad (IP44/IP65 und Höher) zu verwenden, die nur von einem Fachmann installiert werden sollten.

Zone 2:

Oberhalb der Badewanne und /oder der Dusche bzw. daneben und im Abstand von 60 cm oberhalb des Waschbeckens, können alle unsere Badleuchten mit dem Schutzgrad von IP44 montiert werden. Hier können sowohl Niedervolt- als auch Hochvoltleuchten verwendet werden.

Zone 3:

Hier sind in Deutschland alle Leuchten ab einem Schutzgrad von IP20 einsetzbar. Es sollten jedoch Wasserdampf und Spritzwasser, die auf die Leuchten einwirken könnten, vermieden werden. Wenn Sie ganz sicher gehen wollen, verwenden Sie auch hier Leuchten der Schutzklasse IP44.

When IP44 is required

IP44 is made for protection of small parts (>1mm) as well as for splash-water. Our example image shows, which sections are harmless and where IP classes should be taken in consideration.

Zone 1:

Next to the bath tub or shower lights with low voltage and high IP protection class (IP44/IP65 and higher) are mandatory and have to be installed by a professional.

Zone 2:

Above the bath tub or shower or next to it (minimum distance 60cm) all lights with protection class IP44 are adequate. Low voltage lights as well as high voltage lights can be installed.

Zone 3:

In Germany all lights with IP Protection class IP 20 can be installed. Hot steam or splashwater should be avoided. To be safe please use a light with IP protection class IP44.



Glasslight Fix Bulb

SPIEGELKLEMMLEUCHTEN

MIRROR LAMPS



Puk Mini Fix 355
Puk Maxx Fix 357



Puk Mini Fix »+« 355
Puk Maxx Fix »+« 357



Puk Mini Mirror 359
Puk Maxx Mirror 361



Puk Mini Mirror »+« 359
Puk Maxx Mirror »+« 361



Puk Mini Flexlight Fix 363

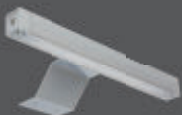

Only Choice Furniture 365



Only Choice Mirror Fix 367



Lichtstange Klemmi 369



Two Socket Fix 371



Flexlight Fix 373



Glass- & Spotlight Fix 375





Puk Mini Fix & Puk Mini Fix »+« Ø 80

Spiegelklemmleuchte, Hochvolt Halogen oder LED Power, dimmbar, Fix »+« Kopf drehbar mit Verstellstift.

Mirror clip lamp, high voltage halogen or LED power, dimmable, rotatable Fix »+« head with adjusting pin.



nickel matt



chrome matt

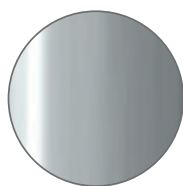

chrome

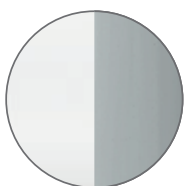

white matt/
chrome

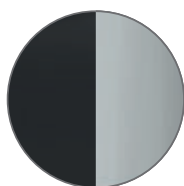

black matt/
chrome

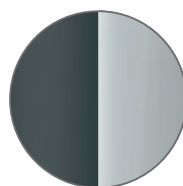

anthracite matt/
chrome

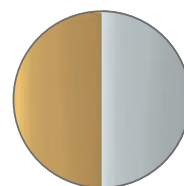

24c gold/
chrome

Puk Mini Fix LED G 2 x 8W ~1.200lm ~2.700k	Puk Mini Fix G9 Fassung 	Länge ab Spiegel mm length from mirror mm	Puk Mini Fix »+« LED G 2 x 8W ~1.200lm ~2.700k	Puk Fix »+« G9 Fassung 	Länge ab Spiegel mm length from mirror mm	Gehäuse body
2-08011-LED	2-08011	90	2-08031-LED	2-08031	100	chrome matt
2-08012-LED	2-08012	90	2-08032-LED	2-08032	100	chrome
2-08013-LED	2-08013	90	2-08033-LED	2-08033	100	nickel matt
2-08012-LED-22	2-08012-22	90	2-08032-LED-22	2-08032-22	100	white matt/chrome
2-08012-LED-02	2-08012-02	90	2-08032-LED-02	2-08032-02	100	black matt/chrome
2-08012-LED-23	2-08012-23	90	2-08032-LED-23	2-08032-23	100	anthracite/chr.
2-08016-LED	2-08016	90	2-08036	2-08036	100	24 carat gold plated/chr.

▶ Ohne Zubehör. Bestell-Artikelnummern für Linse, Glas, Farbfilter und die Konfigurationsempfehlung auf der Einklappseite!

▶ Without accessories: Order item-no. for lens, glass, color filter and the recommended Configuration are on the fold-in page!

Leuchtmittelangabe: LED **G** inkl. | G9 max. 33W ECO, optional LED Retrofit

bulb information: LED **G** incl. | G9 max. 33W ECO, LED Retrofit optional

Leuchtmittlempfehlung: LED max. 3W/300lm/2.700K/dimmbar **G** Art Nr. 8-205

bulb recommendation: LED max. 3W/300Lm/2.700K/dimmable **G** Item No. 8-205

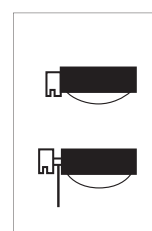
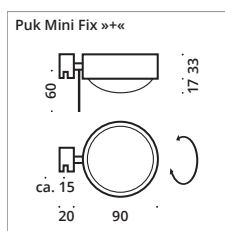
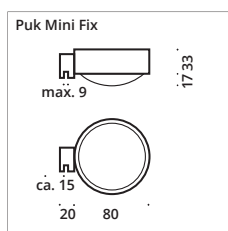

Chrom Teile/
chrome parts
 Gepulverte Teile/
powder-coating





Puk Maxx Fix & Fix »+« Ø 120

Spiegelanbauleuchte, Hochvolt Halogen oder LED Power, dimmbar, bei der »+« Variante Kopf drehbar mit Verstellstift.

Mirror mounting lamp, high voltage halogen or LED power, dimmable, Fix »+« model with rotatable head and adjusting pin.



chrome matt



nickel matt

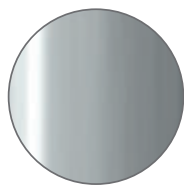

chrome

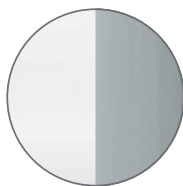

white matt/
chrome

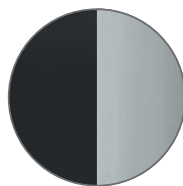

black matt/
chrome

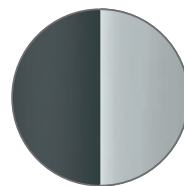

anthracite matt/
chrome

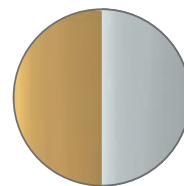

24c gold/
chrome

Puk Maxx Fix LED G 2 x 12W ~1.800lm ~2.700k	Spiegelabstand x Höhe mm mirrorspace x height mm	Puk Maxx Fix »+« LED G 2 x 12W ~1.800lm ~2.700k	Puk Maxx Fix »+« G9 Fassung	Spiegelabstand x Höhe mm mirrorspace x height mm	Gehäuse body
2-308011	130 x 50	2-308031	2-308031-H	140 x 50	chrome matt
2-308012	130 x 50	2-308032	2-308032-H	140 x 50	chrome
2-308013	130 x 50	2-308033	2-308033-H	140 x 50	nickel matt
2-308012-22	130 x 50	2-308032-22	2-308032-H-22	140 x 50	white matt/chrome
2-308012-02	130 x 50	2-308032-02	2-308032-H-02	140 x 50	black matt/chrome
2-308012-23	130 x 50	2-308032-23	2-308032-H-23	140 x 50	anthracite matt/chrome
2-308016	130 x 50	2-308036	2-308036-H	140 x 50	24 ct gold plated/chrome

► Ohne Zubehör. Bestell-Artikelnummern für Linse, Glas, Farbfilter und die Konfigurationsempfehlung auf der Einklappseite!

► Without accessories: Order item-no. for lens, glass, color filter and the recommended Configuration are on the fold-in page!



Leuchtmittelangabe: LED **G** inkl. | G9 max. 33W ECO, optional LED Retrofit

bulb information: LED **G** incl. | G9 max. 33W ECO, LED Retrofit optional

Leuchtmittelempfehlung: LED max. 3W/300lm/2.700K/dimmbar **G** Art Nr. 8-205

bulb recommendation: LED max. 3W/300Lm/2.700K/dimmable **G** Item No. 8-205

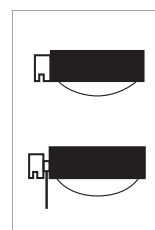
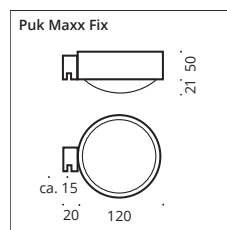
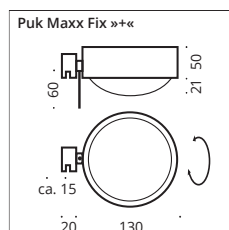

□ Chrom Teile/
chrome parts
■ Gepulverte Teile/
powder-coating

BATH & WELLNESS





Puk Mini Mirror & Puk Mini Mirror »+« Ø 80

Spiegelaufbauleuchte, Hochvolt Halogen oder LED Power, dimmbar, Mirror »+« Kopf drehbar mit Verstellstift.

Mirror mounting lamp, high voltage halogen or LED power, dimmable, Mirror »+« head rotatable with adjusting pin.

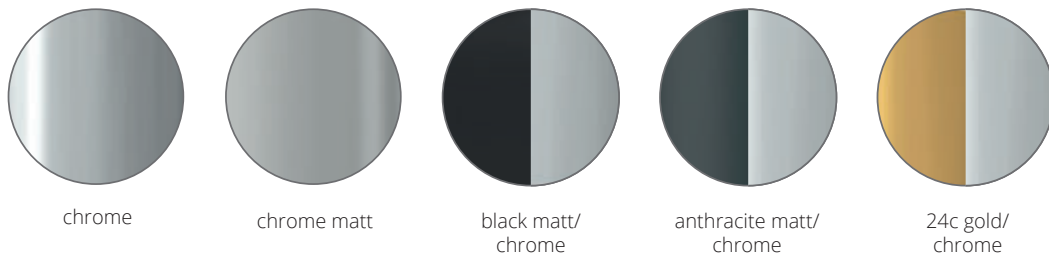

Puk Mirror LED G 2 x 8W ~1.200lm ~2.700k	Puk Mirror G9 Fassung	Länge ab Spiegel mm length from mirror mm	Puk Mirror »+« LED G 2 x 8W ~1.200lm ~2.700k	Puk Mirror »+« G9 Fassung	Länge ab Spiegel mm length from mirror mm	Gehäuse body
● 2-08211-LED	2-08211	80	● 2-08411-LED	2-08411	90	chrome matt
● 2-08212-LED	2-08212	80	● 2-08412-LED	2-08412	90	chrome
● 2-08213-LED	2-08213	80	● 2-08413-LED	2-08413	90	nickel matt
● 2-08212-LED-22	2-08212-22	80	● 2-08412-LED-22	2-08412-22	90	white matt/chrome
● 2-08212-LED-02	2-08212-02	80	● 2-08412-LED-02	2-08412-02	90	black matt/chrome
● 2-08212-LED-23	2-08212-23	80	● 2-08412-LED-23	2-08412-23	90	anthracite matt/chrome
● 2-08216-LED	2-08216	80	● 2-08416-LED	2-08416	90	24 carat gold plated/chr.

- ▶ Ohne Zubehör. Bestell-Artikelnummern für Linse, Glas, Farbfilter und die Konfigurationsempfehlung auf der Einklappseite!
- ▶ Without accessories: Order item-no. for lens, glass, color filter and the recommended Configuration are on the fold-in page!



Leuchtmittelangabe: LED **G** inkl. | G9 max. 33W ECO, optional LED Retrofit
 bulb information: LED **G** incl. | G9 max. 33W ECO, LED Retrofit optional

Leuchtmittelempfehlung: LED max. 3W/300lm/2.700K/dimmbar **G** Art Nr. 8-205
 bulb recommendation: LED max. 3W/300lm/2.700K/dimmable **G** Item No. 8-205

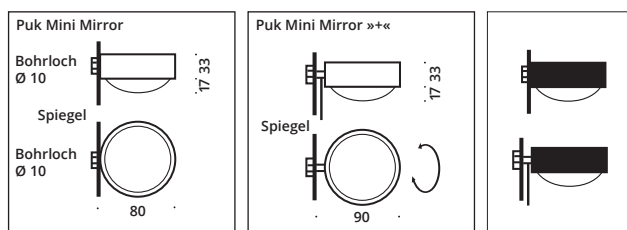

Chrom Teile/
chrome parts
 Gepulverte Teile/
powder-coating

BATH & WELLNESS





Puk Maxx Mirror & Mirror »+« Ø 120

Spiegeleinbauleuchte, Hochvolt Halogen oder LED Power, dimmbar, bei der »+« Variante Kopf drehbar mit Verstellstift.

Mirror mounting lamp, high voltage halogen or LED power, dimmable, »+« model head rotatable with adjusting pin.

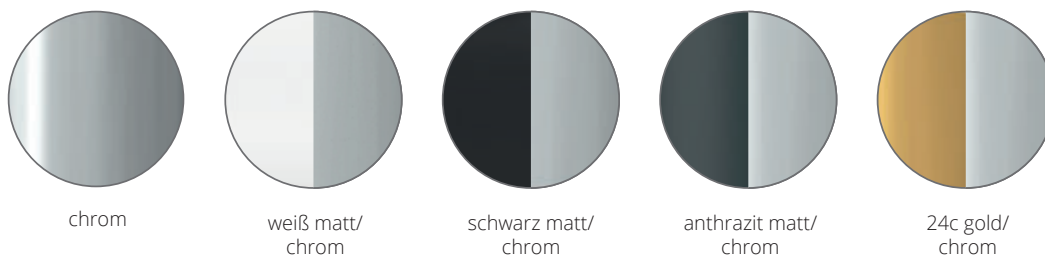

Puk Maxx Mirror LED G 2 x 12W ~1.800lm ~2.700k	Puk Maxx Mirror »+« LED G 2 x 12W ~1.800lm ~2.700k	Puk Maxx Mirror »+« G9 Fassung	Spiegelabstand x Höhe mm mirrorspace x height mm	Gehäuse body
● 2-308211	2-308411	2-308411-H	120/130/145 x 50	chrome matt
● 2-308212	2-308412	2-308412-H	120/130/145 x 50	chrome
● 2-308213	2-308413	2-308413-H	120/130/145 x 50	nickel matt
● 2-308212-22	2-308412-22	2-308412-H-22	120/130/145 x 50	white matt/chrome
● 2-308212-02	2-308412-02	2-308412-H-02	120/130/145 x 50	black matt/chrome
● 2-308212-23	2-308412-23	2-308412-H-23	120/130/145 x 50	anthracite matt/chrome
● 2-308216	2-308416	2-308416-H	120/130/145 x 50	24 ct gold plated/chrome

► Ohne Zubehör. Bestell-Artikelnummern für Linse, Glas, Farbfilter und die Konfigurationsempfehlung auf der Einklappseite!

► Without accessories: Order item-no. for lens, glass, color filter and the recommended Configuration are on the fold-in page!

Leuchtmittelangabe: LED **G** inkl. | G9 max. 33W ECO, optional LED Retrofit

bulb information: LED **G** incl. | G9 max. 33W ECO, LED Retrofit optional

Leuchtmittlempfehlung: LED max. 3W/300lm/2.700K/dimmbar **G** Art Nr. 8-205

bulb recommendation: LED max. 3W/300Lm/2.700K/dimmable **G** Item No. 8-205

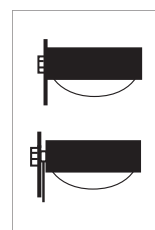
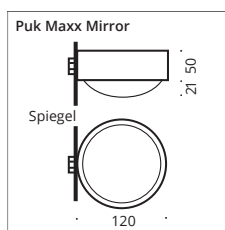
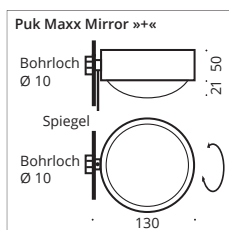

Chrom Teile/
chrome parts
 Gepulverte Teile/
powder-coating





Puk Mini Flexlight Fix \varnothing 80

Puk Mini Spiegelleuchte in Halogen oder LED mit Flexarm und Fixhalterung zur Anbringung an den Spiegel. Gläser/Linsen und Farbfilter werden separat dazubestellt.

Halogen or LED Puk Mini mirror luminaire with flex arm and fixed mount for attaching to the mirror. Glasses/lenses and colour filters are sold separately.

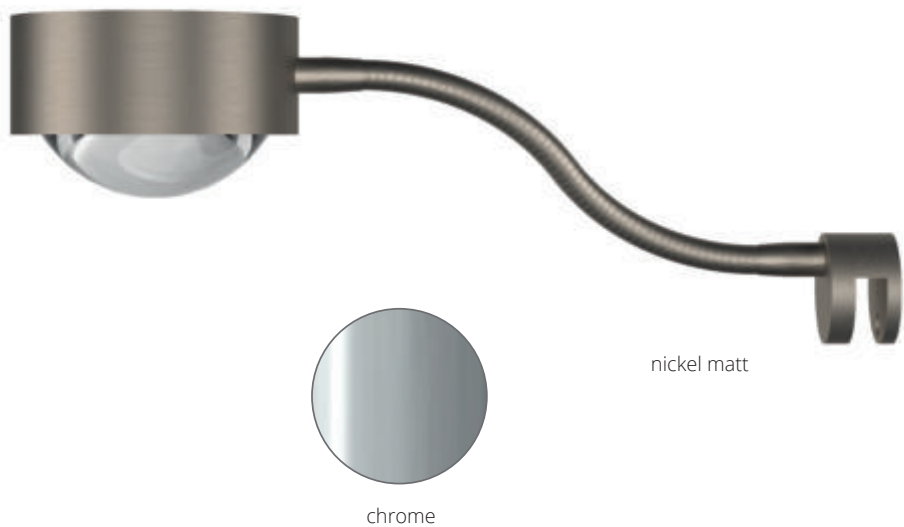

nickel matt

chrome

BATH & WELLNESS

Puk Flexlight Fix LED G 2 x 8W, ~1.200lm ~2.700k	Puk Flexlight Fix G9 Fassung	Armlänge arm length in mm	Gehäuse body
3-2020114-LED	3-2020114	200	chrome
3-2020214-LED	3-2020214	200	nickel matt
3-2030114-LED	3-2030114	300	chrome
3-2030214-LED	3-2030214	300	nickel matt

▶ Ohne Zubehör. Bestell-Artikelnummern für Linse, Glas, Farbfilter und die Konfigurationsempfehlung auf der Einklappeseite!

▶ Without accessories: Order item-no. for lens, glass, color filter and the recommended Configuration are on the fold-in page!



G9 max. 33W, optional LED Retrofit
G9 max. 33W, LED Retrofit optional

Leuchtmittelempfehlung: LED max. 3W/300lm/2.700K/dimmbar **G** Art Nr. 8-205
bulb recommendation: LED max. 3W/300Lm/2.700K/dimmable **G** Item No. 8-205

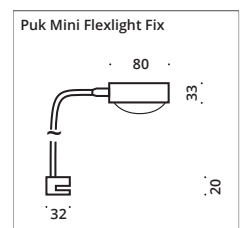

C (s.S 6-7/s.p. 6-7)





Only Choice Furniture

LED Aufsatzleuchte für Badezimmer- und Kosmetikschränke, Regale oder Kleiderschränke. Schraub- oder klebbar. Die Leuchte ist über ein Gelenk schwenkbar. Anfertigung auf Maß für gleiche Spiegel- oder Schrankbreite möglich. Zuleitung mit Kabel und Stecker für die Steckdose.

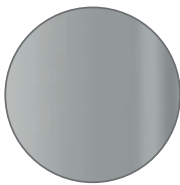

LED attachment light for bathroom and cosmetic cabinets, shelves or wardrobes. Can be screwed or bonded. The luminaire can be swivelled via a joint. Made to measure for the same mirror or cabinet width on request. Feeder with cable and plug for the power socket.

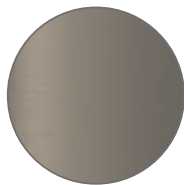

chrome matt



nickel matt

350 mm L	600 mm L	800 mm L	1.250 mm L	Gehäuse body
LED  9W, ~720lm, ~3.000k	LED  13,5W, ~1080lm, ~3.000k	LED  22,5W, ~1800lm, ~3.000k	LED  36W, ~2880lm, ~3.000k	
● 8-60301	8-60601	8-60901	8-601201	chrome matt
● 8-60302	8-60602	8-60902	8-601202	chrome
● 8-60303	8-60603	8-60903	8-601203	nickel matt

Farbig gepulverter Lichtbalken auf Anfrage. Color powdered metal rail on request.



C (s.S 6-7/s.p. 6-7)

Sonderanfertigung:

Art-Nr. 8-600 Kürzung auf Maß

Item No. 8-600 Customized lengths

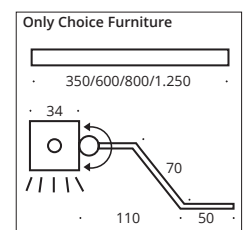





Only Choice Mirror Fix

LED Spiegelklemmleuchte mit Hochleistungsdiffusor für brillantes Ausleuchten des Betrachters. Über ein Gelenk ist die Leuchte dem Betrachter zuschwenkbar. Anfertigung auf Maß für gleiche Spiegel- oder Schrankbreite optional. Zuleitung mit Kabel und Stecker für die Steckdose.

LED mirror clip-on luminaire with high-performance dif-fuser for brilliant illumination of the observer. The luminaire can be swivelled towards the observer via a joint. Made to measure for the same mirror or cabinet width on request. Feeder with cable and plug for the power socket.

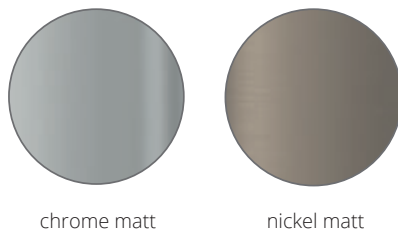

BATH & WELLNESS

350 mm L	600 mm L	800 mm L	1.250 mm L	Gehäuse body
LED G 9W, ~720lm, ~3.000k	LED G 13,5W, ~1080lm, ~3.000k	LED G 22,5W, ~1800lm, ~3.000k	LED G 36W, ~2880lm, ~3.000k	
8-61301	8-61601	8-61901	8-611201	chrome matt
8-61302	8-61602	8-61902	8-611202	chrome
8-61303	8-61603	8-61903	8-611203	nickel matt

Farbig gepulverter Lichtbalken auf Anfrage. Color powdered metal rail on request.



Sonderanfertigung:
Art-Nr. 8-600 Kürzung auf Maß
Item No. 8-600 Customized lengths

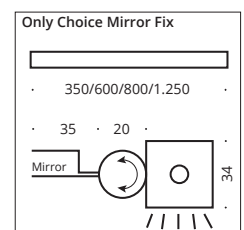





Lichtstange Klemmi

Erhältlich als Wandleuchte, mit LED-Röhre 1-sockelig in opal, optional mit Kippschalter, Wandabstand 70 mm. Als Lichtstange mit Klemmbefestigung zur Montage am Spiegel, mit transparentem Kabel, Schalter und Stecker, Leuchtmittel LED (8W).

Available as wall lamp with LED tube 1-socket in opal. Optionally with flip switch. Wall distance 70 mm. As light light-bar with clip for mounting on mirror, with cable transparent, switch and plug, illuminant LED (8W).

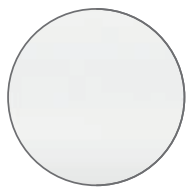

white matt

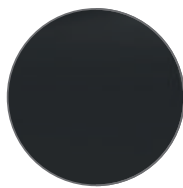

black matt

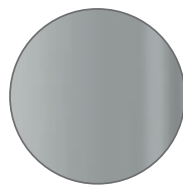

chrome matt



nickel matt

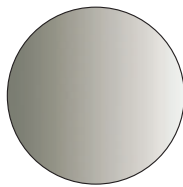

Nickelvelours,
nickel suede

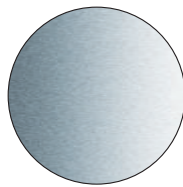

Alumattstruktur,
alum. matt structure

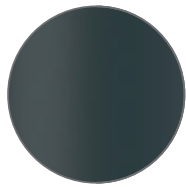

anthracite matt



Optional mit integriertem Schalter
optionally with integrated switch
chrome

Modell model	LED ohne Leuchtmittel without lamp	LED 8W ~700lm, ~2.700k	Ausführung design
● Lichtstange	2-0312	2-0312-LED	chrome
● Klemmi	2-0312-22	2-0312-LED-22	white matt
● Spiegelstärke	2-0312-02	2-0312-LED-02	black matt
● mirror thickness	2-0311	2-0311-LED	chrome matt
● 3-9 mm	2-0319	2-0319-LED	nickel matt
	2-0313	2-0313-LED	nickel suede
	2-0314	2-0314-LED	alum. matt texture
	2-0312-23	2-0312-LED-23	anthracite matt



Für einen integr. Schalter hängen Sie bitte ein -K hinter die Art.-Nr.
Please attach -K behind the item-no. for an integrated switch.

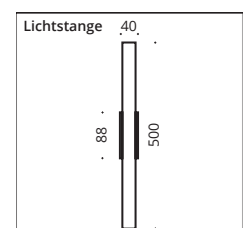





Two Socket

Gerade richtig ist die extra lange Spiegelklemmleuchte für den Spiegeleinsatz.

Just right is this extra long mirror lamp for mirror use.

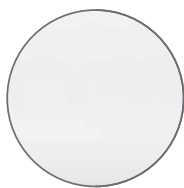

white matt

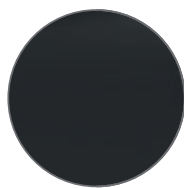

black matt

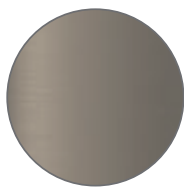

nickel matt

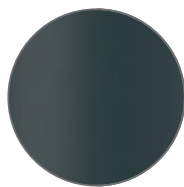

anthracite matt



Two Socket Fix
chrome



Two Socket Base Fix
chrome

Modell model	LED ohne Leuchtmittel without lamp	LED G 16W, ~1.450lm, ~3.000k	Ausführung design	Beschreibung specification
● Two Socket	2-0412	2-0412-LED	chrome	Two Socket mit Klemmbefestigung zur Montage am Spiegel, 2-sockelig, max. 120 Watt Two Socket with clip mounting piece for mirror mounting, 2 bases, max.120 watts
● Fix	2-0419	2-0419-LED	nickel matt	
● Spiegelstärke	2-0412-22	2-0412-LED-22	white matt	
● mirror thickness	2-0412-02	2-0412-LED-02	black matt	
● 3-9 mm	2-0412-23	2-0412-LED-23	anthracite matt	
● Two Socket	2-0432	2-0432-LED	chrome	Two Socket mit Grundplatte und Klemmbefestigung zur Montage am Spiegel, 2-sockelig, max. 120 Watt Two Socket with clip mounting piece for mirror mounting, 2 bases, max.120 watts
● Base Fix	2-0439	2-0439-LED	nickel matt	
● Spiegelstärke	2-0432-22	2-0432-LED-22	white matt	
● mirror thickness	2-0432-02	2-0432-LED-02	black matt	
● 3-9 mm	2-0432-23	2-0432-LED-23	anthracite matt	

Für einen integr. Schalter hängen Sie bitte ein -K hinter die Art.-Nr.
Please attach -K behind the item-no. for an integrated switch.

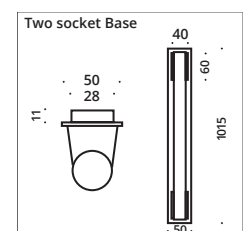
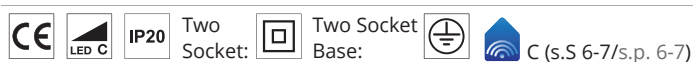





Flexlight Fix



Iglo	India	Pisa	Silk	Rio	Armlänge arm length in mm	Ausführung design
G9 ohne Leuchtmittel without lamp	G9 ohne Leuchtmittel without lamp	G9 ohne Leuchtmittel without lamp	E14 ohne Leuchtmittel without lamp	GU10 ohne Leuchtmittel without lamp		
3-2020101	3-2020102	3-2020103	3-2020105	3-2020117	200	chrome
3-2020201	3-2020202	3-2020203	3-2020205	3-2020217	200	nickel matt
3-2030101	3-2030102	3-2030103	3-2030105	3-2030117	300	chrome
3-2030201	3-2030202	3-2030203	3-2030205	3-2030217	300	nickel matt
3-2040101	3-2040102	3-2040103	3-2040105	3-2040117	400	chrome
3-2040201	3-2040202	3-2040203	3-2040205	3-2040217	400	nickel matt

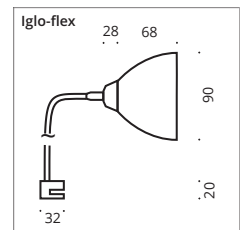

C (s.S 6-7/s.p. 6-7)

G9 max. 33W ECO, optional LED Retrofit G9 max. 33W ECO, LED Retrofit optional	Leuchtmittlempfehlung: LED max. 3W/300lm/2.700K/dimmbar bulb recommendation: LED max. 3W/300Lm/2.700K/dimmable	Art. Nr. 8-205 Item No. 8-205
E14 max. 20W, optional LED Retrofit E14 max. 20W, LED Retrofit optional	Leuchtmittlempfehlung: LED max. 6W/470lm/2.700K bulb recommendation: LED max. 6W/470Lm/2.700K	Art. Nr. 8-524 Item No. 8-524
GU10 max. 35W, optional LED Retrofit GU10 max. 35W, LED Retrofit optional	Leuchtmittlempfehlung: LED max. 4W/230lm/2.700K bulb recommendation: LED max. 4W/230Lm/2.700K	Art. Nr. 8-211 Item No. 8-211

Umbau zum Spiegeleinbau, conversion for mirror mounting
 180° Reflektor optional für Glas Pisa, 180° baffle optional for glass Pisa
 Weitere Schirm-Farben für die Silk finden Sie auf der Einklappseite. You can find more colors for the silk shades on page the fold-in page.

Art.-Nr. 9-3002 chrom (chrome), Art.-Nr. 9-3009 nickelmatt (nickel matt)
 Art.-Nr. 9-204





Glass- & Spotlight Fix



Iglo



Pisa



Pisa Double IP44



India



Rio



Pisa Double



Bulb

Iglo G9 ohne Leuchtmittel without lamp	India G9 ohne Leuchtmittel without lamp	Pisa G9 ohne Leuchtmittel without lamp	Rio GU10 Leuchtmittel without lamp	Ausführung design
2-200101 2-200201	2-200102 2-200202	2-200103 2-200203	2-200117 2-200217	chrome nickel matt

C (s.S 6-7/s.p. 6-7)

Pisa Double G9 ohne Leuchtmittel without lamp	Pisa Double IP44 G9 ohne Leuchtmittel without lamp	Bulb G9 ohne Leuchtmittel without lamp	Ausführung design
2-200130 2-200230	2-200130 IP44 2-200230 IP44	2-200132 2-200232	chrome nickel matt

C (s.S 6-7/s.p. 6-7)

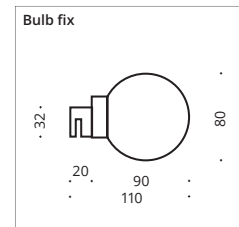
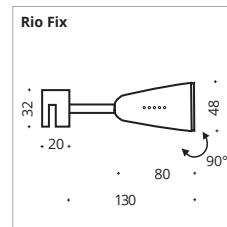

G9 max. 33W ECO, optional LED Retrofit
 G9 max. 33W ECO, LED Retrofit optional

Leuchtmittlempfehlung: LED max. 3W/300lm/2.700K/dimmbar Art Nr. 8-205
 bulb recommendation: LED max. 3W/300Lm/2.700K/dimmable Item No. 8-205

GU10 max. 35W, optional LED Retrofit
 GU10 max. 35W, LED Retrofit optional

Leuchtmittlempfehlung: LED max. 4W/230lm/2.700K
 bulb recommendation: LED max. 4W/230Lm/2.700K Art. Nr. 8-211
 Item No. 8-211

Umbau zum Spiegeleinbau, conversion for mirror mounting

Art.-Nr. 9-3002 chrom (chrome), 9-3009 nickelmatt (nickel matt)

180° Reflektor optional für Glas Pisa, 180° baffle optional for glass Pisa Art.-Nr. 9-204



LICHTSPIEGEL

ILLUMINATED MIRRORS



Mirror Light 391



Lumen Light 393



Palace Light 395



Castle Light 397



Visagist 399



FineLine 401



SideLight 403



DotLight 405



BrightLight 407



InLight 409



BulbLine 411 - 413



Circle 415



Vision 417

Typisch Top Light

Quintessentially Top Light

Technologie

Schattenfreie Ausleuchtung des Betrachters. Kinn-, Hals- und Nasenbereich erhalten ihre optimale Ausleuchtung.

Technology

Shadow-free illumination of the viewer. Chin-, neck- and nose-area are illuminated ideally.

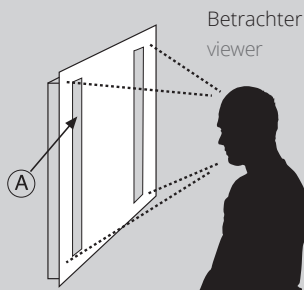

Das Licht

Blendfreie Beleuchtung durch hightech Diffusoren und Reflektoren in: Halogen, Leuchtstoff, LED high Power.

The Light

Anti-glare illumination through high tech diffusers and baffles in: halogen, fluorescent lamps, LED high power.

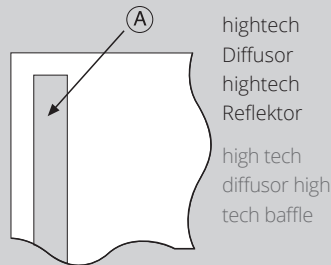

Der Spiegel

Fertigung nach deutscher Spiegelnorm. 12 Schichtverfahren, Kristall Float Glas und eine Reflektionsschicht aus reinem Silber sorgen für eine dauerhafte Tonwiedergabe.

The Mirror

Manufacturing according to German mirror standard. 12 layer proceedings, crystal float glass and a reflective layer made of pure silver provide a durable reproduction.

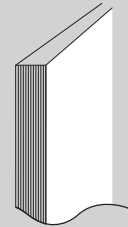

Lichtspiegel Extras Illuminated mirror extras

Facette 20 mm, Facet 20 mm

Einbausteckdose, Flush mounting socket

Einbauschalter, Flush mounting switch

Schalter mittig verdeckt, Switch with central cover

Dimmer mit Taster und Memory, Dimmer with pushbutton and memory

Drehdimmer für Leuchtstoff T5, Rotating dimmer for fluorescent lamp T5

Aluabblendeleiste, Aluminium cover strip

Klappspiegel, Folding mirror

Raumteilerausbildung, Room divider

Spiegelheizung, Mirror heating

Smarthome »Casambi« integriert, Smarthome »Casambi« integrated

UV verklebte Glasablage, UV bonded glass shelf

Gesten- oder Berührungssteuerung, Gesture or Touch Control





Lichtspiegel — Fertigung auch auf Wunschmaß!

Illuminated mirrors — Manufactured to any dimension!

Eine außergewöhnliche und umfangreiche Spiegelkollektion der besonderen Art die keinen Wunsch mehr offen lässt. Die Kristallspiegel sind satiniert, die Kanten geschliffen und poliert. Die Fertigung erfolgt nach deutscher Spiegelnorm.

A very exceptional and extensive collection of mirrors that makes all your wishes come true. The crystal mirrors are glazed, the edges are smoothed and polished. We manufacture according to German mirror standards.

- ▶ Anfertigung nach Maß
- ▶ LED (Farbtemperatur: ~3.000 Kelvin warmweiß*, Farbwiedergabewert: ~95 CRI)
- ▶ Auf Wunsch ist auch die Ausstattung mit 4.000 Kelvin LED möglich
- ▶ IP 44 spritzwassergeschützt (auf Wunsch)
- ▶ ca. 25 mm Wandabstand
- ▶ 6 mm Kristallspiegel (hergestellt nach deutscher Spiegelnorm)
- ▶ auf Wunsch Smarthome »Casambi« integrierbar
- ▶ optional mit Gesten- oder Berührungssteuerung

*je nach Ausführung / gemessen ohne Satinierung

- ▶ Made to measure
- ▶ LED (color temperature: ~3.000 Kelvin warm white*, color reproduction value: ~95 CRI)
- ▶ On request 4.000 Kelvin LED is possible
- ▶ Ip 44 Splash proof (optional)
- ▶ about 25 mm Wall spacing
- ▶ 6 mm crystal mirror (german mirror standards)
- ▶ Smarthome »Casambi« integratable (optional)
- ▶ Gesture or Touch Control (optional)

*depending on version / measured without frosting

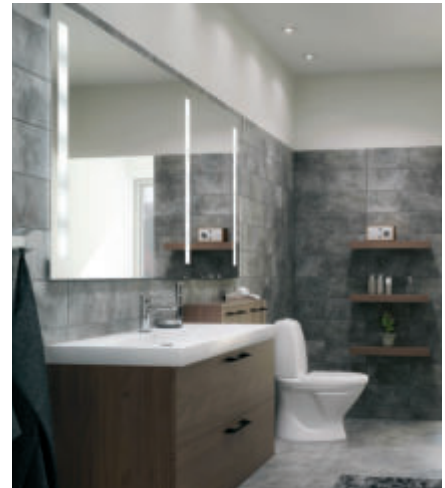

Doppelwaschtisch FineLine



Castle Light

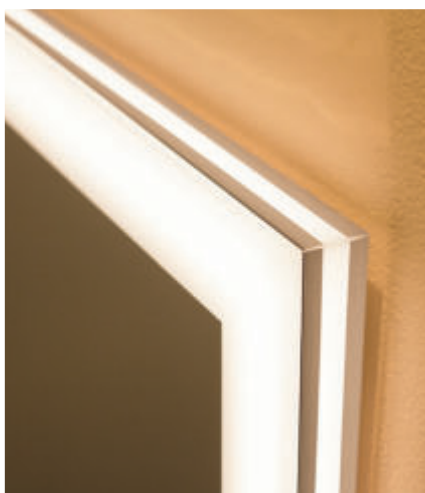

Neues Rahmenprofil kantenbündig



Neues Rahmenprofil eingerückt

Neues Rahmenprofil für Spiegel

Das neue Rahmenprofil wurde speziell für den Einsatz der LED Technik entwickelt. Die LED Module lassen sich bei Bedarf schnell austauschen und stellen somit einen professionellen Service vor Ort sicher. Die verarbeiteten LED haben mit 3.000 Kelvin und einem Farbwiedergabewert von ca. 95 CRI eine optimale Ausleuchtung - perfekt für den gewerblichen Bereich!

New mirror frame profile

The new frame profile was developed specifically for LED technic applications. The LED modules can be changed easily and provide a professional service. 3.000k and about 95 CRI ensure an optimum of illumination. Perfect for the commercial sector!

Gestensteuerung

Nur eine Bewegung entfernt vom perfekten Licht



Die Preise errechnen sich aus den Spiegellistenpreisen zzgl. dem Preis für die gewünschte Gestensteuerungs-Variante.

1. Dimmen und Schalten mit Memoryfunktion
 - An- und Ausschalten
 - stufenloses DimmenArt.-Nr. 1-00119
2. Dimmen, Schalten und stufenlose Änderung der Farbtemperatur von 2.600K bis 5.400K (Tuneable White) mit Memoryfunktion
 - An- und Ausschalten
 - stufenloses Dimmen
 - stufenloser FarbtemperaturwechselArt.-Nr. 1-00107

Gesture Control

Form the mirror you desire

The prices are calculated from the mirror pricelist plus the price for the desired mirror control version:

1. Dim and switch including memory function
 - On/Off
 - dimmingArt.-Nr. 1-00119
2. Dim, switch and color changing from 2,600K bis 5,400K (Tuneable White) including memory function
 - On/Off
 - dimming
 - changing the color temperatureArt.-Nr. 1-00107

GESTENSTEUERUNG/GESTURE CONTROL:

A → C: An/Aus On/Off A ← C: An/Aus On/Off

A → B → Halten/Hold: Dimmen/Dim

C → B → Halten/Hold: Dimmen/Dim

A → C → B → Halten/Hold: Farbtemperatur/
Color Temperature (Tuneable White)

C → A → B → Halten/Hold: Farbtemperatur/
Color Temperature (Tuneable White)

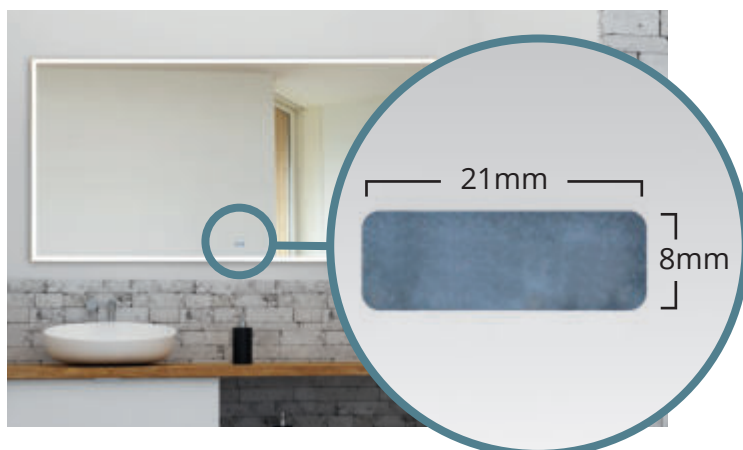



Berührungssteuerung

Nur eine Berührung entfernt vom perfekten Licht

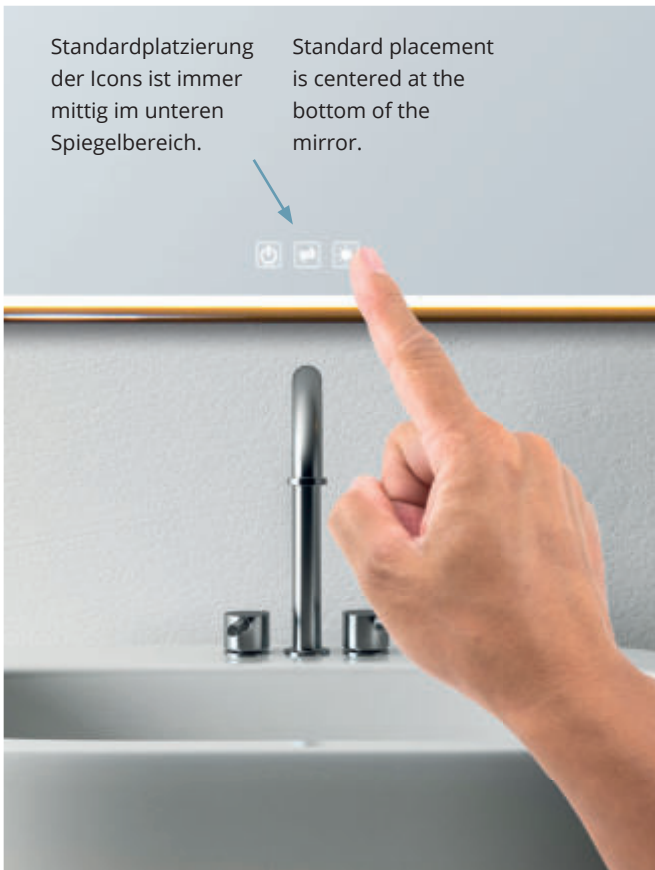

Die Preise errechnen sich aus den Spiegellistenpreisen zzgl. dem Preis für die gewünschte Spiegelsteuerungs-Variante:

1. Dimmen und Schalten mit Memoryfunktion
 - An- und Ausschalten
 - stufenloses Dimmen
 Art.-Nr. 1-00125
2. Dimmen, Schalten und stufenlose Änderung der Farbtemperatur von 2.600K bis 5.400K mit Memoryfunktion
 - An- und Ausschalten
 - stufenloses und schrittweises Dimmen
 - schrittweiser und stufenloser Farbtemperaturwechsel
 Art.-Nr. 1-00126

Touch Control

Form the mirror you desire

The prices are calculated from the mirror pricelist plus the price for the desired mirror control version:











1. Dim and switch including memory function
 - On/Off
 - stepless dimming
 Art.-Nr. 1-00125
2. Dim, switch and color changing from 2,600K bis 5,400K including memory function
 - On/Off
 - dimming stepless and step by step
 - changing the color temperature stepless and step by step
 Art.-Nr. 1-00126

BERÜHRUNGSSTEUERUNG/ TOUCH CONTROL:

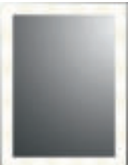
1. An/Aus: kurze Berührung
On/Off: brief Touch
- Dimmen: lange Berührung (5%-100%)
Dim: extended Touch (5%-100%)
2. An/Aus: kurze Berührung
On/Off: brief Touch
- Dimmen: kurze Berührung (5, 30, 60, 100%)
Dim: brief Touch (5, 30, 60, 100%)
- Dimmen: lange Berührung (5%-100%)
Dim: extended Touch (5%-100%)
- Farbtemperatur: kurze Berührung (schrittweise)
Color Temperature: brief Touch (step by step)
- Farbtemperatur: lange Berührung (stufenlos)
Color Temperature: extended Touch (stepless)



Konfigurationsdokumentation Configuration documentation

Bild picture	Name name	Design design	Bild picture	Name name	Design design
	Visagist s. Seite 399 s. page 399	Blockmuster inkl. Prismenabdeckung, seitlich abnehmbar Block pattern design incl. prism cover removable on the side		Mirror Light s. Seite 391 s. page 391	rundum beleuchteter Acryl-Rahmen all-round illuminated acrylic frame
	FineLine s. Seite 401 s. page 401	Linienmuster inkl. Prismenabdeckung, seitlich abnehmbar Lined pattern design incl. prism cover removable on the side		Lumen Light s. Seite 393 s. page 393	rundum beleuchteter Alu-Rahmen all-round illuminated aluminium frame
	SideLight s. Seite 403 s. page 403	umlaufende Linie, rundum satiniert framing line, stained all around		Palace Light s. Seite 395 s. page 395	rundum beleuchteter Alu-Rahmen all-round illuminated aluminium frame
	DotLight s. Seite 405 s. page 405	Punktmuster inkl. Prismenabdeckung, seitlich abnehmbar Dotted pattern design incl. prism cover removable on the side		Castle Light s. Seite 397 s. page 397	rundum beleuchteter Alu-Rahmen all-round illuminated aluminium frame
	BrightLight s. Seite 407 s. page 407	Linienmuster, rechts und links außen satiniert Lined pattern design stained outwards on the left and right side		BulbLine s. Seite 413 s. page 413	Lichtkugeln opal, incl. seitl. Aluabdeckung Light bulbs opal, including lateral aluminium cover
	InLight s. Seite 409 s. page 409	indirekter, seitl. Lichtaustritt Indirect lateral light emission	seitl. Aluabdeckung bei BulbLine Aluminium side cover for BulbLine LED Rahmenprofil LED frame profile		



Circle

runder Spiegel mit umlaufendem Muster
round mirror with framing pattern

VisaCircle



DotCircle



SideCircle



FineCircle





Preisfindung Lichtspiegel Sondergrößen

Pricing Illuminated Mirrors – Special Sizes

für LED Technik:
for techniques: LED

Visagist S.(p.) 399 | FineLine S.(p.) 401 | DotLight S.(p.) 405
BrightLight S.(p.) 407 | InLight S.(p.) 409 | BulbLine S.(p.) 411

Breite max. 3,50 m
width max. 3,50 m



Höhe max. 3,50 m, Height max. 3,50 m

↓

	30	40	50	60	70	80	90	100	110	120	130	140	150	160	170	180	190	200	210	220	
30																					
40																					
50																					
60																					
70																					
80																					
90																					
100																					
110																					
120																					
130																					
140																					
150																					
160																					
170																					
180																					
190																					
200																					
210																					

Preise auf Anfrage

BATH & WELLNESS

Fertigung nach deutscher Spiegelnorm! Inkl. geschliffener und polierter Kante.

Manufactured according to German mirror standards! Including smoothed and polished edge.

Preisfindung Lichtspiegel Sondergrößen

Pricing Illuminated Mirrors – Special Sizes

für Technik: LED-New Line
for techniques: LED-New Line

SideLight S.(p.) 403 | Palace Light S.(p.) 395
Castle Light S.(p.) 397 | Lumen Light S.(p.) 393

Breite max. 3,50 m
width max. 3,50 m



Höhe max. 3,50 m, Height max. 3,50 m

↓

	30	40	50	60	70	80	90	100	110	120	130	140	150	160	170	180	190	200	210	220
30																				
40																				
50																				
60																				
70																				
80																				
90																				
100																				
110																				
120																				
130																				
140																				
150																				
160																				
170																				
180																				
190																				
200																				
210																				

Preise auf Anfrage

Fertigung nach deutscher Spiegelnorm! Inkl. geschliffener und polierter Kante.
Formänderung, Veredelung oder sonst. technische Bearbeitung, siehe Seite 388 – 389.

Manufactured according to German mirror standards! Including smoothed and polished edge.
change of shape, refinement or other technical processing can be found on pages 388-389.



Preisfindung Lichtspiegel Sondergrößen

Pricing illuminated Mirrors – Special Sizes

für Technik: LED-New Line
for techniques: LED-New Line

Mirror Light S.(p.) 391

Breite max. 3,50 m
width max. 3,50 m →

Höhe max. 3,50 m, Height max. 3,50 m ↓

	30	40	50	60	70	80	90	100	110	120	130	140	150	160	170	180	190	200	210	220	
30																					
40																					
50																					
60																					
70																					
80																					
90																					
100																					
110																					
120																					
130																					
140																					
150																					
160																					
170																					
180																					
190																					
200																					
210																					

Preise auf Anfrage

Fertigung nach deutscher Spiegelnorm! Inkl. geschliffener und polierter Kante.
Formänderung, Veredelung oder sonst. technische Bearbeitung, siehe Seite 388 – 389.

Manufactured according to German mirror standards! Including smoothed and polished edge.
change of shape, refinement or other technical processing can be found on pages 388-389.

BATH & WELLNESS

Preisfindung Spiegel ohne Beleuchtung

Pricing Mirrors without Illumination

Preisfindung für Spiegel ohne Beleuchtung, mit unsichtbarer Befestigung.
Pricing for mirrors without illumination, invisible fastening.

für Technik: ohne Beleuchtung
for techniques: without illumination

Breite max. 3,50 m
width max. 3,50 m



Höhe max. 3,50 m, Height max. 3,50 m

↓

	30	40	50	60	70	80	90	100	110	120	130	140	150	160	170	180	190	200	210	
30																				
40																				
50																				
60																				
70																				
80																				
90																				
100																				
110																				
120																				
130																				
140																				
150																				
160																				
170																				
180																				
190																				
200																				
210																				

Preise auf Anfrage

Kristallspiegel, Spiegelstärke: 6 mm, Fertigung nach deutscher Spiegelnorm!

Crystal mirrors, thickness 6mm, manufactured according to German mirror standards!

Basispreise gelten für Quadrat- oder Rechteckspiegel mit geschliffener und polierter Kante (einschließlich unsichtbarer Befestigung), zuzüglich gesetzlicher Mehrwertsteuer. Zwischenmaße entsprechen dem nächsten vollen Maß, z.B.: 62 cm = 70 cm.

Basic prices apply for square or rectangular mirrors with smoothed and polished edges (invisible fastening included) plus VAT. Intermediate sizes correspond to the next higher standard size. (e.g. 62 cm = 70 cm).

Wichtig: Da die Spiegel nach Maß immer mit unsichtbarer Befestigung versehen werden, bitten wir bei Bestellungen um Angabe von **Höhe** und **Breite** des Spiegels.

Important: As mirrors made to measure are always fitted with invisible fixings, please indicate the height and width of the mirror when ordering.



Spiegel ohne Beleuchtung - Bearbeitungszuschläge

Mirrors without Illumination - Processing surcharges

Formen / Art. Nr.
shapes / item no.

Beispiele, examples

Eckabschnitte
beliebige Anzahl
any number of
corner cuts possible
0-0400

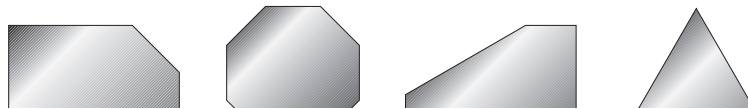

Abrundungen
beliebige Anzahl
any number of
roundings possible
0-0500



Veredelungen für Spiegel **ohne Beleuchtung!** Dressing for mirrors **without illumination!**

Facettenschliff
Facetted cut
20 mm
umlaufend, all round
0-0619



Sonderrahmen, Aussparungen,
spezielle Kantenbearbeitung. Holz, Alu-
minium etc. und Sonderanfertigungen
jeder Art!

Special framings, cut-outs, special edge
processing. Wood, aluminium etc. and
custom designs of all kinds!

Extra Bohrloch
extra borehole
8 - 65 mm
0-07865

65 - 100 mm
0-0765100

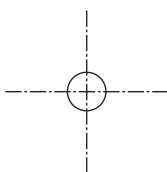

Lichtspiegel Modifikation – Preisfindung

Illuminated Mirrors – Processing surcharges

	Modell / Art. Nr. model / item no.	Beschreibung	description
	Facette facet 1-00190	Veredelung: 20 mm umlaufend gemessen, Restkante geschliffen	dressing: 20 mm framing, rest of edge smoothed
	Dachschrägenausführung Pitched roof version 1-00100	Formabänderung: Spiegelabschnitt ohne beleuchte- ter Schräge, beliebige Anzahl	dimensional change: mirror cutting without illuminated slant, any number
	Dachschrägenausführung Pitched roof version 1-00101	Formabänderung: Spiegelabschnitt mit beleuchte- ter Schräge, beliebige Anzahl	dimensional change: mirror cutting with illuminated slant, any number
	Spiegel mit Bogen mirror with arch 1-00102 1-00105	Formabänderung: ohne Beleuchtung mit Beleuchtung	dimensional change: arch design without illumination arch design with illumination
	Blendschutzprofil Anti-glare profile 1-00110	aus eloxiertem Aluminium, pro Stück (abnehmbares Magnetband)	made of anodized aluminium, per piece (removable magnetic tape)
	Prismenabdeckung prism cover 1-00114	aus PMMA Kunststoff, pro Stück (gesteckt)	made of PMMA plastic, per piece (inserted)
	Klappspiegel einseitig Folding mirror, one-way 1-00113	Breite max. 40 cm, Höhe wie Spiegel bis 100 cm (andere Größen auf Anfrage), Klappteil ist beidseitig verspiegelt!	width max 40 cm, height like mirrors up to 100 cm (other sizes available on request). Folding parts are mirrored on both sides.
	Kippspiegelhalterung tilting mirror attachment SP-145	Kippspiegelhalterung: Behindertengerecht, 35° nach vorne neigbar	tilting mirror attachment: handicapped accessible, forward tilting angle 35°
	Extra Leuchtfeld (satiniert) Extra light field (satin finish) 1-020000	Zusätzliche Sonderanfertigung: (z.B.: beim Doppelwaschtisch)	additional custom-made option (e.g. with the double washbasin.)
	Extra Leuchtstelle Bulbine extra light source Bulbine 2-0501	Opalglasausführung, 60 mm Kugel, 20W G9, incl. Bohrloch ($\varnothing = 24$ mm)	Opal glass design, 60 mm bulb, 20W G9, incl. borehole ($\varnothing = 24$ mm)



Lichtspiegel Modifikation – Preisfindung

Illuminated Mirrors – Processing surcharges

Modell / Art. Nr. model / item No.	Beschreibung	description
Bohrung borehole 0-07865 0-0765100	Extra Bohrung: 8 – 65 mm 65 – 100 mm	extra borehole : 8 – 65 mm 65 – 100 mm
IP 44 1-IP44	für LED spritzwassergeschützt	for LED splash proof
Schalter switch 1-00881	Schalter (verdeckt), unten mittig (verdrahtet)	switch (covered), central bottom (wired)
Schalter switch 1-00885	Einbau (Berker), chrom, vorverdrahtet, inkl. 50 mm Bohrung	flush-mounting (Berker), chrome, pre-wired, incl. 50 mm borehole
Steckdose socket 1-00882	Einbau, (Berker), chrom, vorverdrahtet, 3,5 cm Wandabstand, inkl. 50 mm Bohrung	flush mounting (Berker), chrome, pre-wired, 3.5 cm wall-spacing, including 50 mm borehole
Spiegel ... mirror ... 1-00118	... mit Magnethalterung	... with magnetic attachment
1-08777	Audio Soundsystem, integriert (Bluetooth)	Audio soundsystem, integrated (bluetooth)
1-08789	Spiegelheizung	mirror heating
1-08999	Splitterschutz	splinter protection
s. Casambi Seite s. Casambi Page	Smarthome »Casambi«	Smarthome »Casambi«
1-081330 L 300 mm 1-081340 L 400 mm 1-081350 L 500 mm 1-081360 L 600 mm 1-081380 L 800 mm 1-081390 L 900 mm 1-0813100 L 1.000 mm 1-0813120 L 1.200 mm	UV-verklebte Glasablage 130 mm tief, vorne 2 Rundecken 10 mm	UV bonded glass shelf, 130 mm depth, rounded corbers in the front 10 mm





Gestensteuerung (auf Seite 380):
Gesture Control (on page 380):

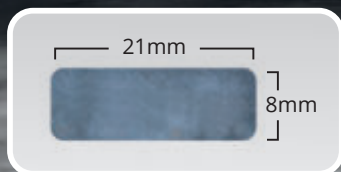

Berührungssteuerung (auf Seite 381):
Touch Control (on page 381):





Mirror Light LED

Kristallspiegel mit durchgängig leuchtendem Acryl-Rahmen und integrierter LED Beleuchtung, gefertigt nach deutscher Spiegelnorm. Erhältlich in jedem Wunschmaß.

Crystal mirror with continuously illuminated acrylic frame and integrated LED lighting, manufactured according to German mirror standards. Available in customized sizes.



Mirror Light



Lichtaustritt
light emission

Mirror Light Detail



Alu Rahmenprofil

Leuchtmittel Lamps

LED ~740lm
10W/m, RA ~95



Kristallspiegel mit beleuchtetem Rahmen, inkl. Leuchtmittel.
Glazed crystal mirror with illuminated frame, including lamps.

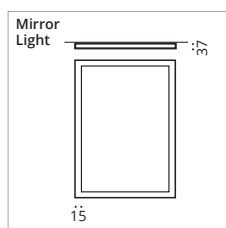

Bei Bestellung Höhe und Breite angeben.
Specify height and width when ordering.

H 800 x B 600 mm



29-80601

H 900 x B 700 mm



29-90701

H 1400 x B 700 mm



29-140701

H 1600 x B 700 mm



29-160701

BATH & WELLNESS

Ihr Traumspiegel ist nicht dabei?

Kein Problem – auf den Seiten 383 – 389 können Sie sich ihren Spiegel ganz individuell zusammenstellen!

Haven't found your dream mirror?

No problem – on page 383 – 389 you can design and arrange your personal mirror individually!

LED **G**





Gestensteuerung (auf Seite 380):
Gesture Control (on page 380):

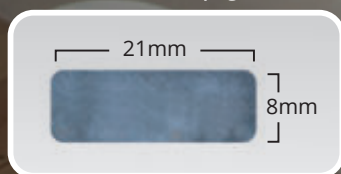

Berührungssteuerung (auf Seite 381):
Touch Control (on page 381):





Lumen Light LED

Kristallspiegel mit hochwertigem, eloxiertem Alu-Rahmen in den Oberflächen Silber, Champagner und Schwarz. Rundum integrierte LED Beleuchtung im Rahmen, gefertigt nach deutscher Spiegelnorm. Erhältlich in jedem Wunschmaß.

Crystal mirror with high-quality anodized aluminium frame in silver, champagne and black. All-round integrated LED lighting in the frame, manufactured according to German mirror standards. Available in any desired size.



Lumen Light black

Die Rahmen sind erhältlich in den Farben Silber, Champagner und Schwarz.
The frames are available in the colors silver, champagne and black.

H 800 x B 600 mm



silver
28-806020
champagne
28-806021
black
28-806022

H 900 x B 700 mm



silver
28-907020
champagne
28-907021
black
28-907022

H 1400 x B 700 mm



silver
28-1407020
champagne
28-1407021
black
28-1407022

H 1600 x B 700 mm



silver
28-1607020
champagne
28-1607021
black
28-1607022

Leuchtmittel Lamps

LED ~740lm
10W/m, RA ~95

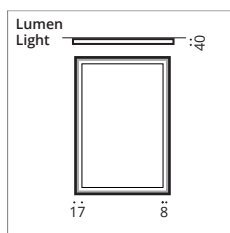

Alurahmen mit Chromverblendung am Lichtprofil.
Aluminium frame with chrom facing at the light profile.

Kristallspiegel mit beleuchtetem Rahmen, inkl. Leuchtmittel.
Glazed crystal mirror with illuminated frame, including lamps.

Ihr Traumspiegel ist nicht dabei?

Kein Problem – auf den Seiten 383 – 389 können Sie sich ihren Spiegel ganz individuell zusammenstellen!

Haven't found your dream mirror?

No problem – on page 383 – 389 you can design and arrange your personal mirror individually!





Ihr Traumspiegel ist nicht dabei?

Kein Problem – auf den Seiten 383 – 389 können Sie sich ihren Spiegel ganz individuell zusammenstellen!

Haven't found your dream mirror?

No problem – on page 383 – 389 you can design and arrange your personal mirror individually!

**Gestensteuerung (auf Seite 380):
Gesture Control (on page 380):**

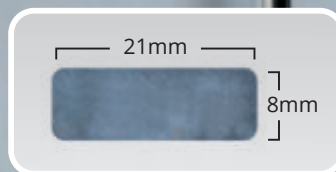

**Berührungssteuerung (auf Seite 381):
Touch Control (on page 381):**





Palace Light LED

Kristallspiegel mit hochwertigem, eloxiertem Alu-Rahmen in verschiedenen Oberflächen. Integrierte LED Beleuchtung im und seitlich am Rahmen, gefertigt nach deutscher Spiegelnorm.

Crystal mirror with high-quality anodised aluminium frame in various surfaces. Integrated LED lighting inside and on the side of the frame. Manufactured according to German mirror standards.



Palace Light champagne

Die Rahmen sind erhältlich in den Farben Silber, Champagner und Schwarz.
The frames are available in the colors silver, champagne and black.

H 700 x B 600 mm



silver
26-706020
champagne
26-706021
black
26-706022

H 900 x B 700 mm



silver
26-907020
champagne
26-907021
black
26-907022

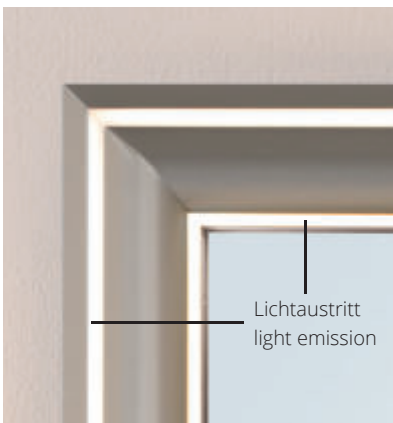

Lichtaustritt
light emission

Palace Light champagne

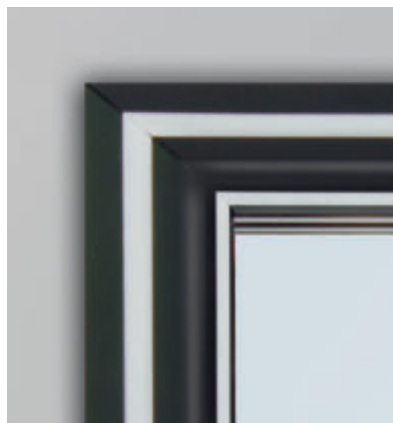

Palace Light black

H 1400 x B 700 mm



silver
26-1407020
champagne
26-1407021
black
26-1407022

H 1600 x B 700 mm



silver
26-1607020
champagne
26-1607021
black
26-1607022

Leuchtmittel Lamps

LED ~1.480lm
20W/m, RA ~95



Kristallspiegel mit beleuchtetem Rahmen, inkl. Leuchtmittel.
Glazed crystal mirror with illuminated frame, including lamps.

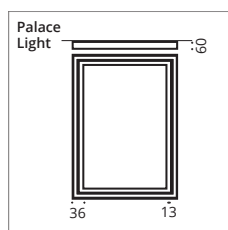



Ihr Traumspiegel ist nicht dabei?

Kein Problem – auf den Seiten 383 – 389 können Sie sich ihren Spiegel ganz individuell zusammenstellen!

Haven't found your dream mirror?

No problem – on page 383 – 389 you can design and arrange your personal mirror individually!

**Gestensteuerung (auf Seite 380):
Gesture Control (on page 380):**



**Berührungssteuerung (auf Seite 381):
Touch Control (on page 381):**





Castle Light LED

Kristallspiegel mit hochwertigem, eloxiertem Alu-Rahmen in verschiedenen Oberflächen. Integrierte LED Beleuchtung im und hinter dem Rahmen, gefertigt nach deutscher Spiegelnorm.

Crystal mirror with high-quality, anodized aluminum frame in different surfaces. Integrated LED lighting in and behind the frame, manufactured according to German mirror standards.

Dieser Spiegel kann erst ab einer minimalen Außenmaß-Länge von 510 mm gefertigt werden.

This mirror can only be manufactured from a minimum outer dimension of 510 mm.



Castle Light silver

Die Rahmen sind erhältlich in den Farben Silber, Champagner und Schwarz.
The frames are available in the colors silver, champagne and black.

H 700 x B 600 mm



silver
27-706020
champagne
27-706021
black
27-706022

H 900 x B 700 mm



silver
27-907020
champagne
27-907021
black
27-907022

H 1400 x B 700 mm



silver
27-1407020
champagne
27-1407021
black
27-1407022

H 1600 x B 700 mm



silver
27-1607020
champagne
27-1607021
black
27-1607022

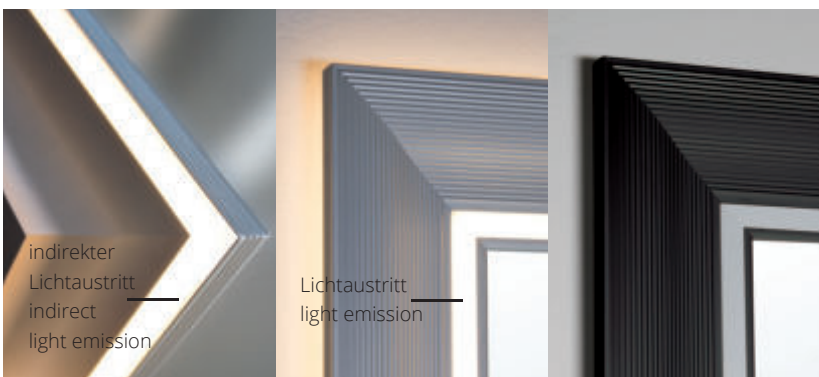

Rückansicht/rear view

Castle Light silver

Castle Light black

Leuchtmittel Lamps

LED ~1.480lm
20W/m, RA ~95



Kristallspiegel mit beleuchtetem Rahmen, inkl. Leuchtmittel.

Glazed crystal mirror with illuminated frame, including lamps.

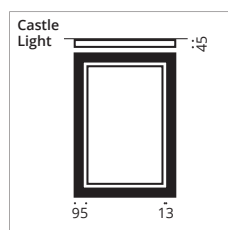

LED **G**





Gestensteuerung (auf Seite 380):
Gesture Control (on page 380):

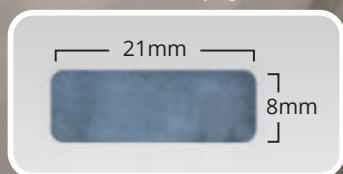

Berührungssteuerung (auf Seite 381):
Touch Control (on page 381):





Visagist LED

Standardgrößen Standard sizes

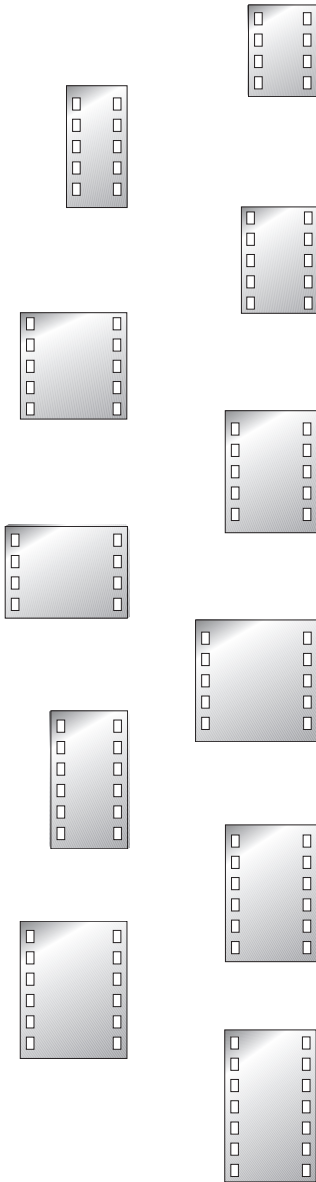

Visagist / Art. Nr. Visagist / item no.	Kristallspiegel satiniert, inkl. seitlicher Prismenabdeckung, abnehmbar crystal mirror frosted, incl. removable, lateral prism cover	Maße in mm (H x B x T) dimensions in mm (h x w x d)
1-016045-LED	20 W/m	600 x 450 x 25
1-018040-LED	20 W/m	800 x 400 x 25
1-017050-LED	20 W/m	700 x 500 x 25
1-017070-LED	20 W/m	700 x 700 x 25
1-018060-LED	20 W/m	800 x 600 x 25
1-016080-LED	20 W/m	600 x 800 x 25
1-018080-LED	20 W/m	800 x 800 x 25
1-019050-LED	20 W/m	900 x 500 x 25
1-019060-LED	20 W/m	900 x 600 x 25
1-019070-LED	20 W/m	900 x 700 x 25
1-0110060-LED	20 W/m	1000 x 600 x 25

BATH & WELLNESS

Leuchtmittel Lamps
LED
20W/m, ~1.500lm

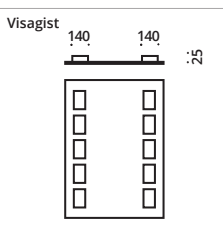
Kristallspiegel satiniert,
Kanten geschliffen und
poliert, Blockmuster, inkl.
Leuchtmittel.
Glazed crystal mirror with
smoothed and polished
edges, block pattern
design, incl. lamps.

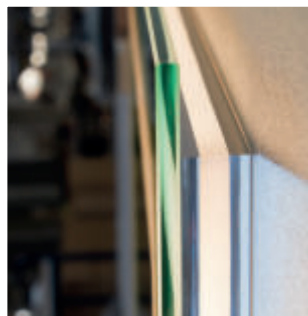

Neues Rahmenprofil eingerückt

Ihr Traumspiegel ist nicht dabei?

Kein Problem – auf den
Seiten 383 – 389 können
Sie sich ihren Spiegel
ganz individuell zusam-
menstellen!

Haven't found your dream mirror?

No problem – on page
383 – 389 you can
design and arrange
your personal mirror
individually!

LED 





Gestensteuerung (auf Seite 380):
Gesture Control (on page 380):



Berührungssteuerung (auf Seite 381):
Touch Control (on page 381):





FineLine LED

Standardgrößen Standard sizes

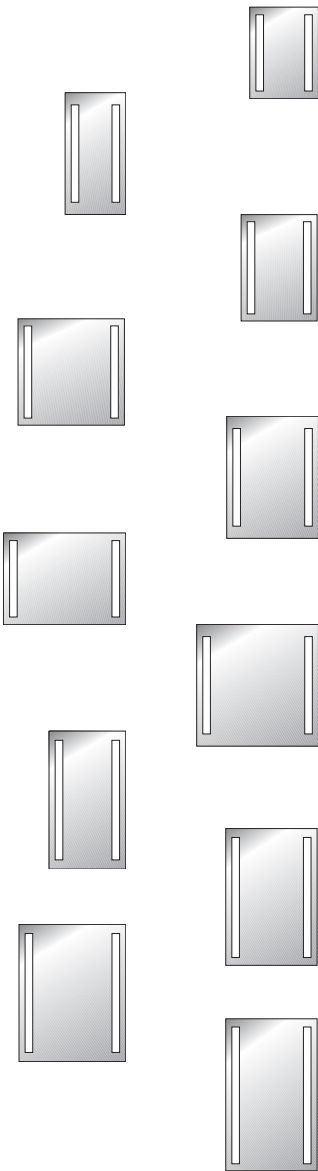

FineLine / Art. Nr. FineLine / item no.	Kristallspiegel satiniert, inkl. seitlicher Prismenabdeckung, abnehmbar Crystal mirror frosted, incl. removable, lateral prism cover	Maße in mm (H x B x T) dimensions in mm (h x w x d)
1-026045-LED	20 W/m	600 x 450 x 25
1-028040-LED	20 W/m	800 x 400 x 25
1-027050-LED	20 W/m	700 x 500 x 25
1-027070-LED	20 W/m	700 x 700 x 25
1-028060-LED	20 W/m	800 x 600 x 25
1-026080-LED	20 W/m	600 x 800 x 25
1-028080-LED	20 W/m	800 x 800 x 25
1-029050-LED	20 W/m	900 x 500 x 25
1-029060-LED	20 W/m	900 x 600 x 25
1-029070-LED	20 W/m	900 x 700 x 25
1-0210060-LED	20 W/m	1000 x 600 x 25

BATH & WELLNESS

Leuchtmittel Lamps
LED
20W/m, ~1.500lm

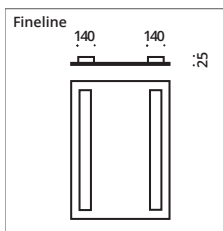

Kristallspiegel satiniert, Kanten geschliffen und poliert, Streifenmuster, inkl. Leuchtmittel. Gefertigt nach Deutscher Spiegelnorm.

Glazed crystal mirror with smoothed and polished edges, striped pattern design, incl. lamps. Manufactured according to German mirror standards.

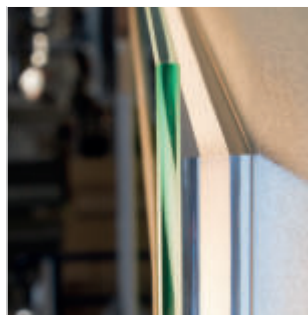

Neues Rahmenprofil eingerückt

Ihr Traumspiegel ist nicht dabei?

Kein Problem – auf den Seiten 383 – 389 können Sie sich ihren Spiegel ganz individuell zusammenstellen!

Haven't found your dream mirror?

No problem – on page 383 – 389 you can design and arrange your personal mirror individually!

LED





Gestensteuerung (auf Seite 380):
Gesture Control (on page 380):



Berührungssteuerung (auf Seite 381):
Touch Control (on page 381):





SideLight LED

Standardgrößen Standard sizes

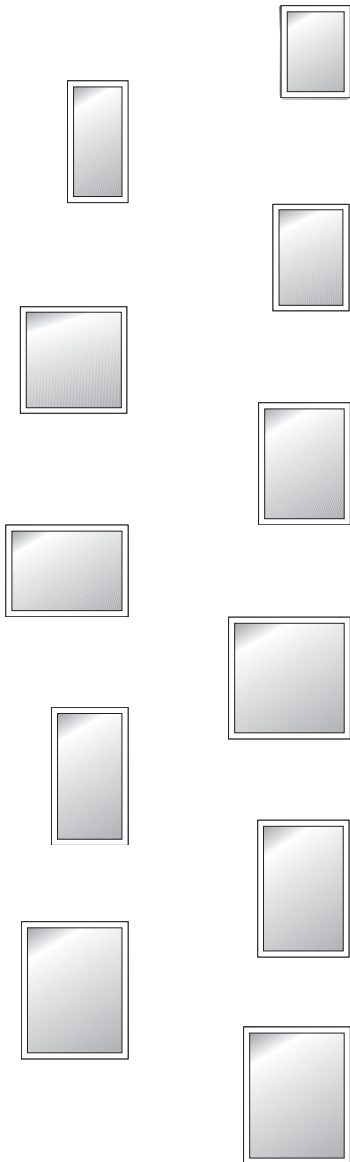

SideLight / Art. Nr. SideLight / item no.	Kristallspiegel satiniert, ohne Prismenabdeckung crystal mirror frosted, without lateral prism cover	Maße in mm (H x B x T) dimensions in mm (h x w x d)
1-036045-LED	20 W/m	600 x 450 x 25
1-038040-LED	20 W/m	800 x 400 x 25
1-037050-LED	20 W/m	700 x 500 x 25
1-037070-LED	20 W/m	700 x 700 x 25
1-038060-LED	20 W/m	800 x 600 x 25
1-036080-LED	20 W/m	600 x 800 x 25
1-038080-LED	20 W/m	800 x 800 x 25
1-039050-LED	20 W/m	900 x 500 x 25
1-039060-LED	20 W/m	900 x 600 x 25
1-039070-LED	20 W/m	900 x 700 x 25
1-0310060-LED	20 W/m	1000 x 600 x 25

Leuchtmittel Lamps
LED
20W/m, ~1.500lm

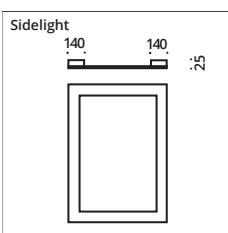

Kristallspiegel satiniert,
Kanten geschliffen und
poliert, Streifenmuster,
inkl. Leuchtmittel.

Glazed crystal mirror
with smoothed and
polished edges, striped
pattern design, including
lamps.



Neues Rahmenprofil kantenbündig

Ihr Traumspiegel ist nicht dabei?

Kein Problem – auf den
Seiten 383 – 389 können
Sie sich ihren Spiegel
ganz individuell zusam-
menstellen!

Haven't found your dream mirror?

No problem – on page
383 – 389 you can
design and arrange
your personal mirror
individually!





Gestensteuerung (auf Seite 380):
Gesture Control (on page 380):

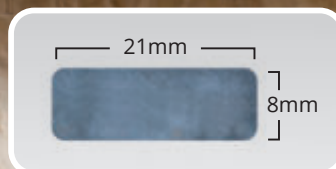

Berührungssteuerung (auf Seite 381):
Touch Control (on page 381):





DotLight LED

Standardgrößen Standard sizes

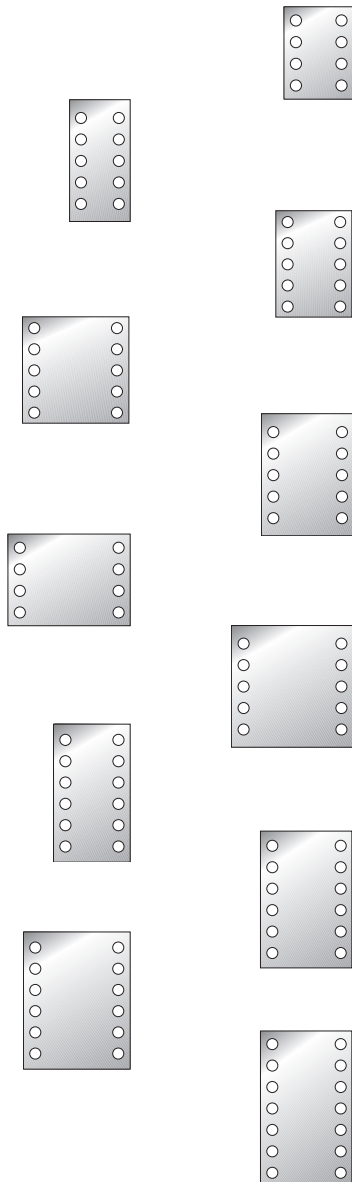

DotLight / Art. Nr. DotLight / item no.	Kristallspiegel satiniert, inkl. seitlicher Prismenabdeckung, abnehmbar crystal mirror frosted, incl. removable, lateral prism cover	Maße in mm (H x B x T) dimensions in mm (h x w x d)
1-056045-LED	20 W/m	600 x 450 x 25
1-058040-LED	20 W/m	800 x 400 x 25
1-057050-LED	20 W/m	700 x 500 x 25
1-057070-LED	20 W/m	700 x 700 x 25
1-058060-LED	20 W/m	800 x 600 x 25
1-056080-LED	20 W/m	600 x 800 x 25
1-058080-LED	20 W/m	800 x 800 x 25
1-059050-LED	20 W/m	900 x 500 x 25
1-059060-LED	20 W/m	900 x 600 x 25
1-059070-LED	20 W/m	900 x 700 x 25
1-0510060-LED	20 W/m	1000 x 600 x 25

Leuchtmittel Lamps
LED
20W/m, ~1.500lm

Satinierungs-
durchmesser
Glazing diameter
40 mm

DotLight

Kristallspiegel satiniert, Kanten
geschliffen und poliert, Punkt-
muster, inkl. Leuchtmittel.

Glazed crystal mirror with
smoothed and polished
edges, dot pattern design,
including lamps.



Neues Rahmenprofil eingerückt

Ihr Traumspiegel ist nicht dabei?

Kein Problem – auf den
Seiten 383 – 389 können
Sie sich ihren Spiegel
ganz individuell zusam-
menstellen!

Haven't found your
dream mirror?

No problem – on page
383 – 389 you can
design and arrange
your personal mirror
individually!

LED





Gestensteuerung (auf Seite 380):
Gesture Control (on page 380):



Berührungssteuerung (auf Seite 381):
Touch Control (on page 381):





BrightLight LED

Standardgrößen Standard sizes

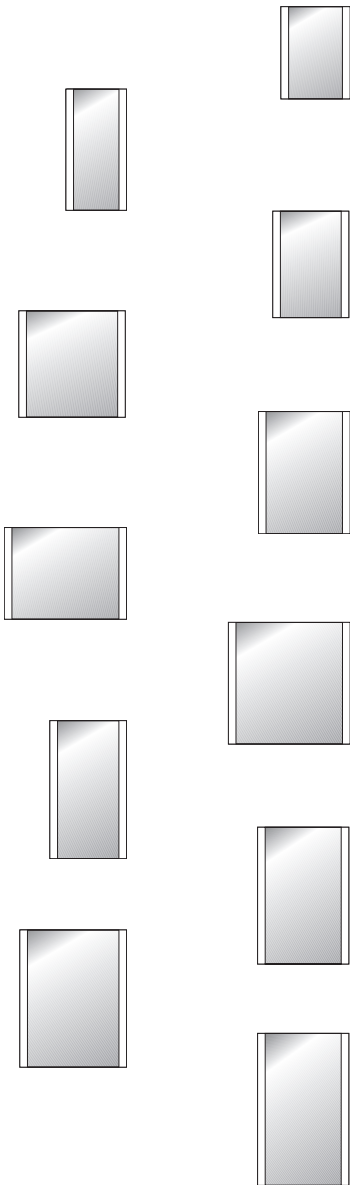

BrightLight / Art. Nr. BrightLight / item no.	Kristallspiegel satiniert, ohne Prismenabdeckung crystal mirror frosted, without lateral prism cover	Maße in mm (H x B x T) dimensions in mm (h x w x d)
1-066045-LED	20 W/m	600 x 450 x 25
1-068040-LED	20 W/m	800 x 400 x 25
1-067050-LED	20 W/m	700 x 500 x 25
1-067070-LED	20 W/m	700 x 700 x 25
1-068060-LED	20 W/m	800 x 600 x 25
1-066080-LED	20 W/m	600 x 800 x 25
1-068080-LED	20 W/m	800 x 800 x 25
1-069050-LED	20 W/m	900 x 500 x 25
1-069060-LED	20 W/m	900 x 600 x 25
1-069070-LED	20 W/m	900 x 700 x 25
1-0610060-LED	20 W/m	1000 x 600 x 25

BATH & WELLNESS

Leuchtmittel Lamps
LED
20W/m, ~1.500lm

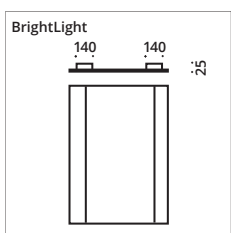

Kristallspiegel satiniert, Kanten geschliffen und poliert, Streifenmuster, inkl. Leuchtmittel.
Glazed crystal mirror with smoothed and polished edges, striped pattern design, including lamps.



Neues Rahmenprofil kantenbündig

Ihr Traumspiegel ist nicht dabei?
Kein Problem – auf den Seiten 383 – 389 können Sie sich ihren Spiegel ganz individuell zusammenstellen!

Haven't found your dream mirror?
No problem – on page 383 – 389 you can design and arrange your personal mirror individually!

LED





Gestensteuerung (auf Seite 380):
Gesture Control (on page 380):



Berührungssteuerung (auf Seite 381):
Touch Control (on page 381):





InLight LED

Standardgrößen Standard sizes

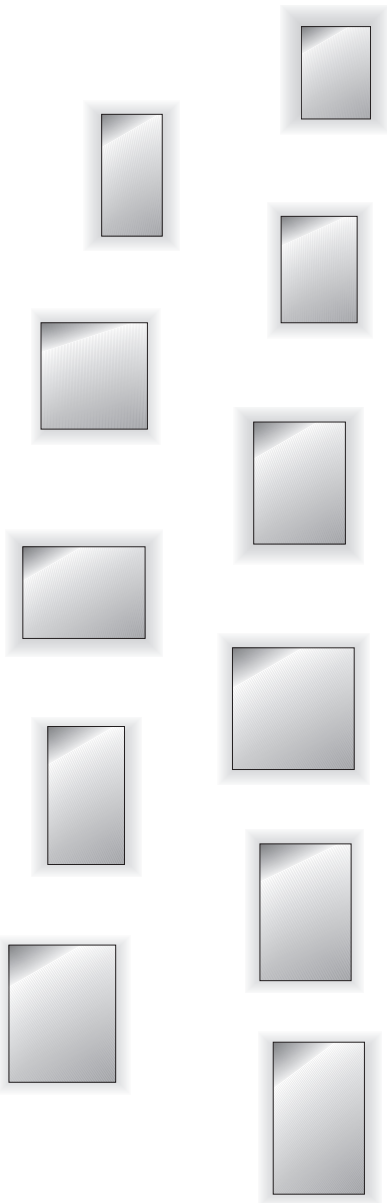

InLight / Art. Nr. InLight / item no.	Kristallspiegel ohne Prismenabdeckung crystal mirror without lateral prism cover	Maße in mm (H x B x T) dimensions in mm (h x w x d)
1-076045-LED	20 W/m	600 x 450 x 25
1-078040-LED	20 W/m	800 x 400 x 25
1-077050-LED	20 W/m	700 x 500 x 25
1-077070-LED	20 W/m	700 x 700 x 25
1-078060-LED	20 W/m	800 x 600 x 25
1-076080-LED	20 W/m	600 x 800 x 25
1-078080-LED	20 W/m	800 x 800 x 25
1-079050-LED	20 W/m	900 x 500 x 25
1-079060-LED	20 W/m	900 x 600 x 25
1-079070-LED	20 W/m	900 x 700 x 25
1-0710060-LED	20 W/m	1000 x 600 x 25

BATH & WELLNESS

Leuchtmittel Lamps
LED
20W/m, ~1.500lm

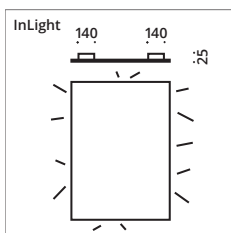

Lichtprofil eingerückt

Ihr Traumspiegel ist nicht dabei?

Kein Problem – auf den Seiten 383 – 389 können Sie sich ihren Spiegel ganz individuell zusammenstellen!

Haven't found your dream mirror?

No problem – on page 383 – 389 you can design and arrange your personal mirror individually!

LED



Hochvolt Halogen, IP 44! Leuchtmittelwartung von vorne!
High voltage halogen, IP 44! Maintenance from the front side.





BulbLine

Der klassische Halogenlichtspiegel mit seinen Lichtkugeln in Opalglasausführung bietet Ihnen viel Gestaltungsraum, um Ihre eigenen Vorstellungen perfekt umzusetzen. Designen Sie Ihren eigenen Spiegel, ganz nach Ihren Wünschen!

The classic halogen light mirror with its light bulbs in opal glass design offers you a lot of room for your creativity. Design your own mirror according to your imagination, just as you wish!

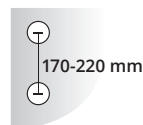

Opalglasausführung,
ø 60 mm Kugel, inkl. Bohrloch
Opal glass design
ø 60 mm bulb, incl. borehole
2-0501

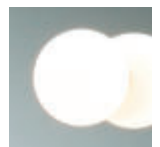

Empfohlener Abstand der Lampen zueinander: 170-220 mm,
Randabstand mind. 60 mm! Bohrloch ø = 24 mm.
Recommended spacing between lamps: 170-220 mm, edge
distance minimum 60mm! Borehole ø = 24 mm.

Opalisierte Lichtkugeln mit unsichtbarer Befestigung,
Spiegelstärke 6 mm, Wandabstand 10 mm

Opalescent light bulbs with invisible fastening,
mirror thickness 6 mm, wall spacing 10 mm.





BulbLine

Standardgrößen Standard sizes

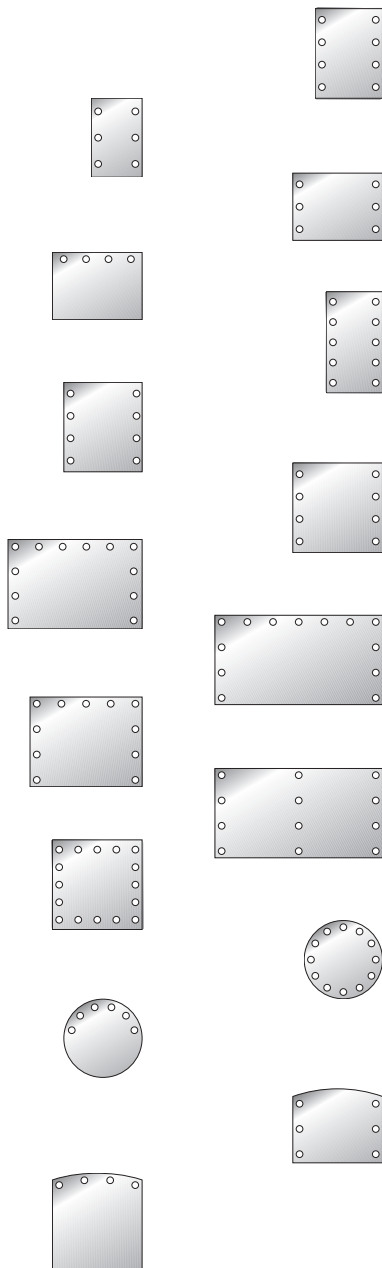

BulbLine / Art. Nr. BulbLine / item no.	Kristallspiegel mit Opalglas Lichtkugeln ohne Prismenabdeckung crystal mirror with light bulbs in opal glass without lateral prism cover	Maße in mm (H x B x T) dimensions in mm (h x w x d)
1-0480608-O	2 x 4 LS	800 x 600
1-0470456-O	2 x 3 LS	700 x 450
1-0460806-O	2 x 3 LS	600 x 800
1-0460804-O	1 x 4 LS	600 x 800
1-04806010-O	2 x 5 LS	800 x 600
1-0480708-O	2 x 4 LS	800 x 700
1-0480808-O	2 x 4 LS	800 x 800
1-048012012-O	12 LS	800 x 1200
1-048015013-O	13 LS	800 x 1500
1-048010011-O	11 LS	800 x 1000
1-048015012-O	3 x 4 LS	800 x 1500
1-04808016-O	16 LS	800 x 800
1-047012-O	12 LS	∅ 700
1-04706-O	6 LS	∅ 700
1-0465806-O-B	2 x 3 LS	650 x 800 Bogenhöhe 60 Arch rise 60
1-0485804-O-B	4 LS	850 x 800 Bogenhöhe 60 Arch rise 60

Für Zubehör siehe Seite 388-389. For Equipment see page 388-389.

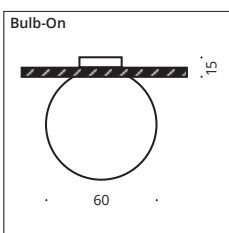

Der Wandabstand beträgt normal 10 mm. Achtung: erhöhter Wandabstand von 35 mm bei integriertem Steckdosenaufbau.

The wall spacing is normally 10 mm. Attention: Increased wall spacing with surface mounted socket (35mm)!

Leuchtmittelangabe

G9 max 20W; opt. LED

Ersatzleuchtmittel

Art. Nr. 8-205:
LED ~3W ~300lm ~2.700k





Gestensteuerung (auf Seite 380):
Gesture Control (on page 380):

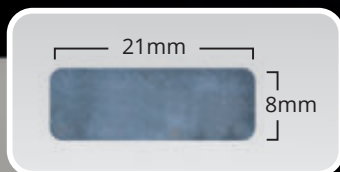

Berührungssteuerung (auf Seite 381):
Touch Control (on page 381):





Circle

Circle ist ein runder Lichtspiegel in satiniertem Kristallglas, inkl. Leuchtmittel LED oder G4 klar, gefertigt nach deutscher Spiegelnorm.

The Circle model is a round illuminated mirror made of glazed crystal glass including LED or G4 clear lamps. Manufactured according to German mirror standards.



DotCircle



SideCircle

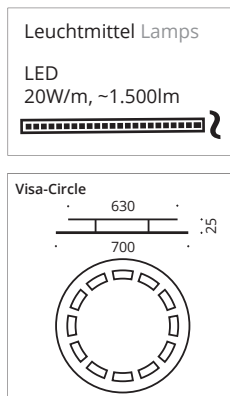

Circle / Art. Nr. Circle / item no.	Kristallspiegel satinert, ohne Prismenabdeckung Crystal mirror frosted, without lateral prism cover	Standard- größe ø mm Standard Size ø mm
VisaCircle 1-0170-LED	20 W/m	700
FineCircle 1-0270-LED	20 W/m	700
SideCircle 1-0370-LED	20 W/m	700
DotCircle 1-0570-LED	20 W/m	700
InCircle 1-0670-LED	20 W/m	700

LED **G**



Zusätzlich zur Standardgröße fertigen wir den Circle auch in Sondergrößen mit LED-Power.
In addition to the standard sizes, we also manufacture the Circle model in special sizes with LED-Power.



Gestensteuerung (auf Seite 380):
Gesture Control (on page 380):

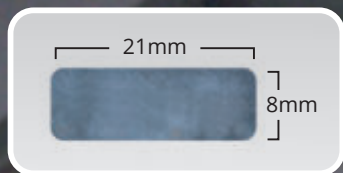

Berührungssteuerung (auf Seite 381):
Touch Control (on page 381):





Vision

- Raumteiler -

Als Visagist, FineLine und DotLight, alle Größen auf Maß, mit LED und Leuchtstofflampe T5 lieferbar.

- Room divider -

Available in the versions Visagist, FineLine and DotLight. All sizes available with LED or fluorescent lamp T5.

Modell / Art. Nr. model / item no.	Beschreibung description
Raumteiler Vision Aufbau room divider Vision surface mounting 1-00103	VA gebürstet, beidseitig beleuchtet, Lieferumfang: VA Gestänge, Befestigungsequipment, Magnethalterung und modifizierter Lichtspiegel Brushed VA, illumination on both sides. Scope of delivery: VA support, fastening equipment, magnet attachment, and modified illuminated mirror
Raumteiler Vision Einbau room divider Vision recessed mounting 1-00104	VA gebürstet, beidseitig beleuchtet, Lieferumfang: VA Gestänge, Befestigungsequipment, Magnethalterung und modifizierter Lichtspiegel Brushed VA, illumination on both sides. Scope of delivery: VA support, fastening equipment, magnet attachment, and modified illuminated mirror
Schalter switch 1-00881	verdeckter Schalter unten mittig covered switch, bottom (central)



BATH & WELLNESS

Leuchtmittel Lamps
LED
20W/m, ~1.500lm

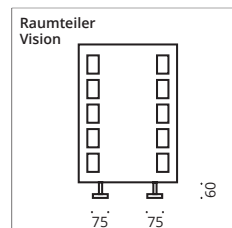
LED 

CE IP20 IP44  12 V = 230 V



Gestensteuerung (auf Seite 380):
Gesture Control (on page 380):



Berührungssteuerung (auf Seite 381):
Touch Control (on page 381):





BATH & WELLNESS

Lichtspiegel Doppelwaschtisch
Illuminated mirror double washbasin



OUTDOOR COLLECTION

- | | |
|---------------------------|-----------|
| 1. Deckenleuchten | 424 - 439 |
| 2. Wandleuchten | 440 - 445 |
| 3. Poller-/Schirmleuchten | 446 - 453 |
| 4. Bodeneinbauleuchten | 454 - 464 |

Außenbeleuchtung ist eines der wichtigsten Themen bei der Objektbeleuchtung für den Privat-, oder Gewerbebereich. So lässt sich mit der richtigen Ausleuchtung jede Architektur richtig in Szene setzen. Illumination auf höchstem Niveau und Lichtakzente an den richtigen Stellen des Objektes machen erst den Unterschied zwischen Tag und Nacht klar. Leuchten aus unserem Programm hauchen Nacht und Dämmerung ein Eigenleben ein, das zum Betrachten einlädt.

Wir freuen uns Ihnen unsere neu überarbeitete Outdoor Collection präsentieren zu dürfen.

Neu relaunched sind alle Puk Outdoor Leuchten mit neuer Oberfläche und Haptik in Feinstruktur. In eigener Manufaktur werden die Leuchten weiß matt, schwarz matt, anthrazit matt und soft braun matt gepulvert und eingebrannt und sind damit witterungsbeständig, farbecht, sowie UV-stabil.

One main focus for facility lighting are lights for outdoor areas. Put the scenes into the perfect light with the perfect luminaires. Illumination on its highest level helps to perceive the difference between day- and nighttime. Liven up the night and be astonished about the vivid existence of lights.

We are pleased to present you our newly revised Outdoor Collection.

All Puk Outdoor luminaires have been relaunched with a new surface and haptic in fine structure. The luminaires are powder-coated in white matt, black matt, anthracite matt and soft brown matt in our own manufactory and are therefore weatherproof, non-fading and UV-stable.





24



Puk Maxx Wall Outdoor

MAIN CONTENT OUTDOOR COLLECTION

1. Deckenleuchten 424 - 439



Puk Mini Plus OD 425



Puk Maxx Plus OD 427



Puk Meg Maxx Plus OD 429



Puk Mini Turn OD 431



Puk Maxx Turn OD 433



Allround Flat OD 435



Foxx Cube OD 437



Foxx Round OD 439

2. Wandleuchten 440 - 445

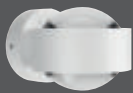

Puk Mini Wall OD 441



Puk Maxx Wall OD 443



Puk Meg Maxx Wall OD 445

3. Poller-/Schirmleuchten 446 - 453



Puk Mini Way II 447



Puk Maxx Way II 449



Octopus Mini OD 451



Octopus OD 453

4. Bodeneinbauleuchten 454 - 463



Light Stone Beton OD 457



Light Stone Basalt OD 459



Light Stone Cristal OD 461





Puk Mini Plus Outdoor \varnothing 80

LED Deckenleuchte für den Außenbereich (IP44). Aus Metall-Spritzguß mit hochwertiger und robuster Feinstruktur Pulverbeschichtung. Optional können zu Linse oder Glas die Farbfilter dazu kombiniert werden.

LED ceiling luminaire for outdoor use (IP44). Made of metal injection moulding with high-quality and robust fine structure powder coating. Optionally, lens or glass as well as color filters can be combined.



white matt
fine structure

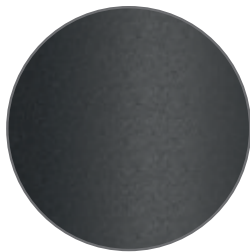

black matt
fine structure

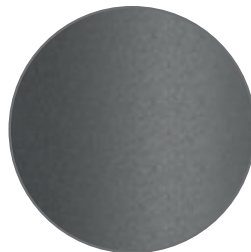

anthracite matt
fine structure

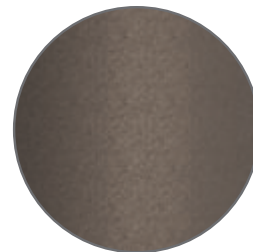

softbrown matt
fine structure

Puk Mini Plus Outdoor	\varnothing x H in mm \varnothing x h in mm	Gehäuse body
LED  ~2.700k 1 x 8W ~600lm		
2-48112-30	80 x 70	white matt, fine structure
2-48112-31	80 x 70	black matt, fine structure
2-48112-32	80 x 70	anthracite matt, fine structure
2-48112-33	80 x 70	softbrown matt, fine structure

- ▶ Ohne Zubehör. Bestell-Artikelnummern für Linse, Glas, Farbfilter und die Konfigurationsempfehlung (2) auf der Einklappseite! 
- ▶ Without accessories: Order item-no. for lens, glass, color filter and the recommended Configuration (2) are on the fold-in page!

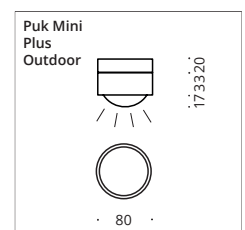

OUTDOOR





Puk Maxx Plus Outdoor \varnothing 120

LED Deckenleuchte für den Außenbereich (IP44). Aus Metall Spritzguß mit hochwertiger und robuster Feinstruktur Pulverbeschichtung. Optional können zu Linse oder Glas die Farbfilter dazu kombiniert werden.

LED ceiling luminaire for outdoor use (IP44). Made of metal injection moulding with high-quality and robust fine structure powder coating. Optionally, lens or glass as well as color filters can be combined.



white matt
fine structure

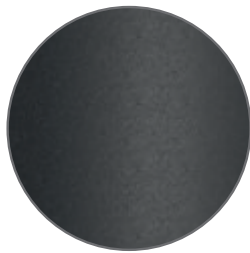

black matt
fine structure

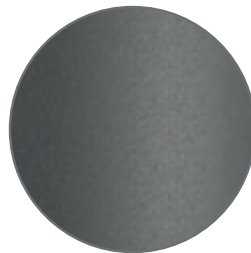

anthracite matt
fine structure

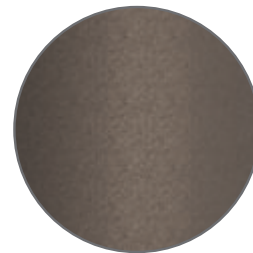

softbrown matt
fine structure

Puk Maxx Plus Outdoor LED G ~2.700k 1 x 12W ~900lm	\varnothing x H in mm \varnothing x h in mm	Gehäuse body
2-4018002-30	120 x 96	white matt, fine structure
2-4018002-31	120 x 96	black matt, fine structure
2-4018002-32	120 x 96	anthracite matt, fine structure
2-4018002-33	120 x 96	softbrown matt, fine structure

- ▶ Ohne Zubehör. Bestell-Artikelnummern für Linse, Glas, Farbfilter und die Konfigurationsempfehlung (2) auf der Einklappseite!
- ▶ Without accessories: Order item-no. for lens, glass, color filter and the recommended Configuration (2) are on the fold-in page!

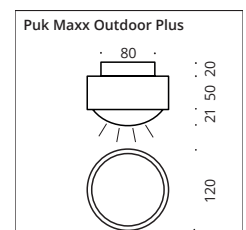

OUTDOOR



Puk Meg Maxx Plus Outdoor



Puk Meg Maxx Plus Outdoor \varnothing 160

LED Deckenleuchte für den Außenbereich (IP44). Aus Metall Spritzguß mit hochwertiger und robuster Feinstruktur Pulverbeschichtung. Optional können zu Linse oder Glas die Farbfilter dazu kombiniert werden.

LED ceiling luminaire for outdoor use (IP44). Made of metal injection moulding with high-quality and robust fine structure powder coating. Optionally, lens or glass as well as color filters can be combined.



white matt
fine structure

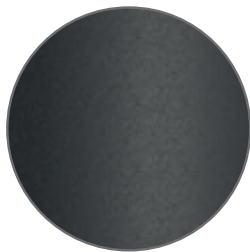

black matt
fine structure

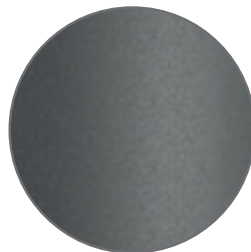

anthracite matt
fine structure

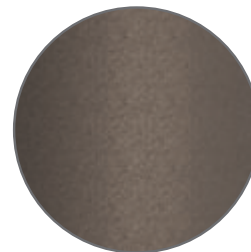

softbrown matt
fine structure

Puk Meg Maxx Plus Outdoor	\varnothing x Höhe in mm \varnothing x height in mm	Gehäuse body
LED G \sim 2.700k 1 x 18W, \sim 1.500lm		
2-50802-30	160 x 80	white matt, fine structure
2-50802-31	160 x 80	black matt, fine structure
2-50802-32	160 x 80	anthracite matt, fine structure
2-50802-33	160 x 80	softbrown matt, fine structure

► Ohne Zubehör. Bestell-Artikelnummern für Linse, Glas, Farbfilter und die Konfigurationsempfehlung (2) auf der Einklappseite!



► Without accessories: Order item-no. for lens, glass, color filter and the recommended Configuration (2) are on the fold-in page!

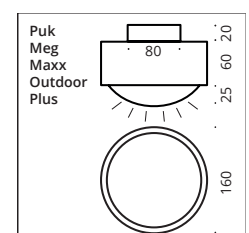

OUTDOOR





Puk Mini Turn Outdoor \varnothing 80

LED Deckenleuchte für den Außenbereich (IP44). Aus Metall Spritzguß mit hochwertiger und robuster Feinstruktur Pulverbeschichtung. Kopf nicht dreh- und kippbar. Optional können zu Linse oder Glas die Farbfilter dazu kombiniert werden.

LED ceiling luminaire for outdoor use (IP44). Made of metal injection moulding with high-quality and robust fine structure powder coating. Head not tiltable. Optionally, lens or glass as well as color filters can be combined.



white matt
fine structure

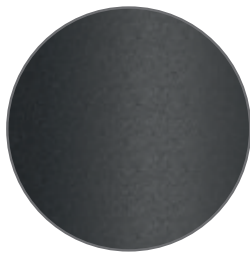

black matt
fine structure

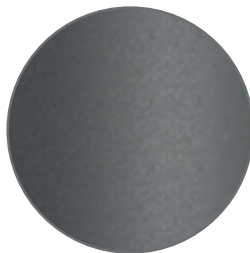

anthracite matt
fine structure

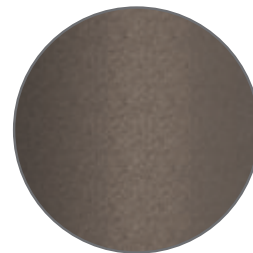

softbrown matt
fine structure

Puk Mini Turn Outdoor LED  ~2.700k downlight 1 x 8W ~600lm	\varnothing x H in mm \varnothing x h in mm	Gehäuse body
2-48212-30	80 x 120	white matt, fine structure
2-48212-31	80 x 120	black matt, fine structure
2-48212-32	80 x 120	anthracite matt, fine structure
2-48212-33	80 x 120	softbrown matt, fine structure

- ▶ Ohne Zubehör. Bestell-Artikelnummern für Linse, Glas, Farbfilter und die Konfigurationsempfehlung (2) auf der Einklappseite! 
- ▶ Without accessories: Order item-no. for lens, glass, color filter and the recommended Configuration (2) are on the fold-in page!

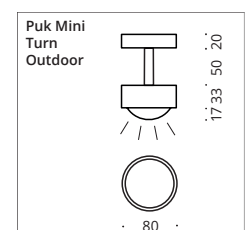

OUTDOOR





Puk Maxx Turn Outdoor \varnothing 120

LED Deckenleuchte für den Außenbereich (IP44) mit downlight oder up- & downlight. Aus Metall Spritzguß mit hochwertiger und robuster Feinstruktur Pulverbeschichtung. Kopf nicht dreh- und kippbar. Optional können zu Linse oder Glas die Farbfilter dazu kombiniert werden.

LED ceiling luminaire for outdoor use (IP44) with downlight or up- and downlight. Made of metal injection moulding with high-quality and robust fine structure powder coating. Head not tiltable. Optionally, lens or glass as well as color filters can be combined.



white matt
fine structure

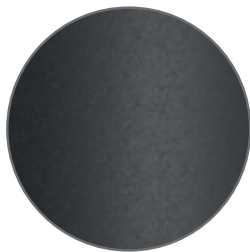

black matt
fine structure

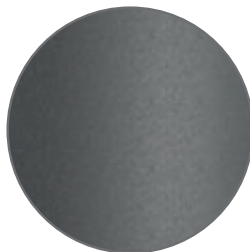

anthracite matt
fine structure

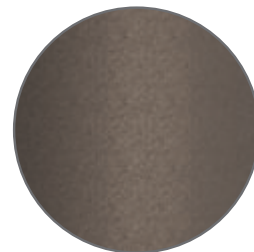

softbrown matt
fine structure

Puk Maxx Turn Outdoor LED G ~2.700k	\varnothing x H in mm \varnothing x h in mm	Gehäuse body
downlight 1 x 12W ~900lm 2-4028002-30 2-4028002-31 2-4028002-32 2-4028002-33	120 x 146 120 x 146 120 x 146 120 x 146	white matt, fine structure black matt, fine structure anthracite matt, fine structure softbrown matt, fine structure
up- & downlight 2 x 8W ~1.200lm 2-4038002-30 2-4038002-31 2-4038002-32 2-4038002-33	120 x 146 120 x 146 120 x 146 120 x 146	white matt, fine structure black matt, fine structure anthracite matt, fine structure softbrown matt, fine structure

- ▶ Ohne Zubehör. Bestell-Artikelnummern für Linse, Glas, Farbfilter und die Konfigurationsempfehlung (2) auf der Einklappseite!
- ▶ Without accessories: Order item-no. for lens, glass, color filter and the recommended Configuration (2) are on the fold-in page!

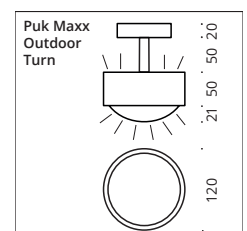

OUTDOOR





Allround Flat Outdoor \varnothing 120/160/240

Diese flache Aufbauleuchte wurde für den Deckeneinsatz konstruiert. Sie ist dimmbar und in 3 Leuchtenkopfdurchmessern erhältlich (\varnothing 120mm/8W/920lm, \varnothing 160mm/12W/1300lm, \varnothing 240mm/16W/1600lm, durchgängig 2700k). Mit der Schutzklasse IP44 eignet sich die Allround Flat sehr gut für den Außenbereich.

This flat surface mounted luminaire is designed for ceiling use. It is dimmable and available in 3 luminaire head diameters. (\varnothing 120mm/8W/920lm, \varnothing 160mm/12W/1300lm, \varnothing 240mm/16W/1600lm, 2700k throughout). With IP44 protection class, the Allround Flat is very suitable for outdoor use.

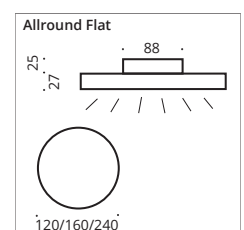
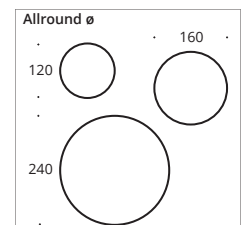
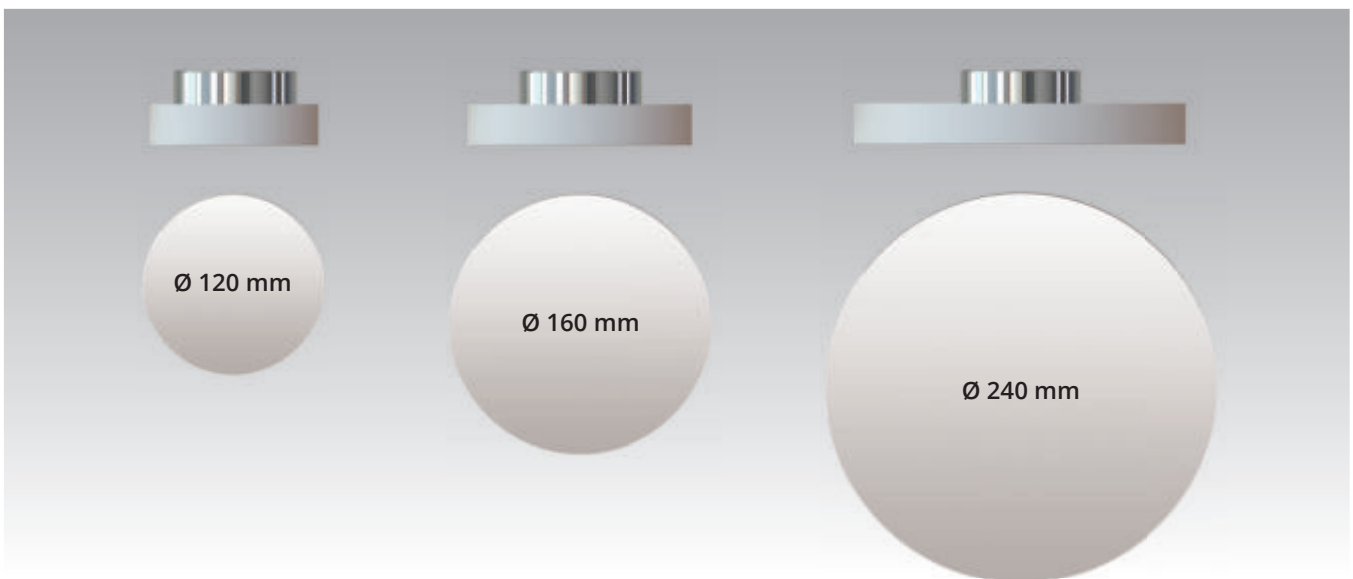

Allround 120 mm \varnothing LED G 8 Watt, ~2.700k ~920 lm 7-2421212	Allround 160 mm \varnothing LED G 12 Watt, ~2.700k ~1.300 lm 7-2421612	Allround 240 mm \varnothing LED G 16 Watt, ~2.700k ~1.600 lm 7-2422412	Wandschild/ Leuchtkörper Wall Shield/Luminous Body chrome/frosted solid acrylic
---	--	--	--



OUTDOOR





Foxx Cube Outdoor \varnothing 200/300/400/500

Mit 20 mm ist die Cube eine sensationell flache LED Deckenleuchte in den Maßen 200/300/400/500 mm. Als Auf- oder Einbauleuchte passt sie sich allen Stilrichtungen an. Mit der eingesetzten LED Hochvolttechnik heißt es nur noch »plug and light« für In- oder Outdoor (IP44).

With an unbelievable height of 20 mm the slim LED lamp can be mounted on ceilings. Dimensions are available in 200/300/400/500 mm. As built-in or surface mounted luminaire for all kind of lighting requirements. With its high power LED assembly is as easy as possible. "Plug and light" for Indoor and Outdoor (IP44) areas.

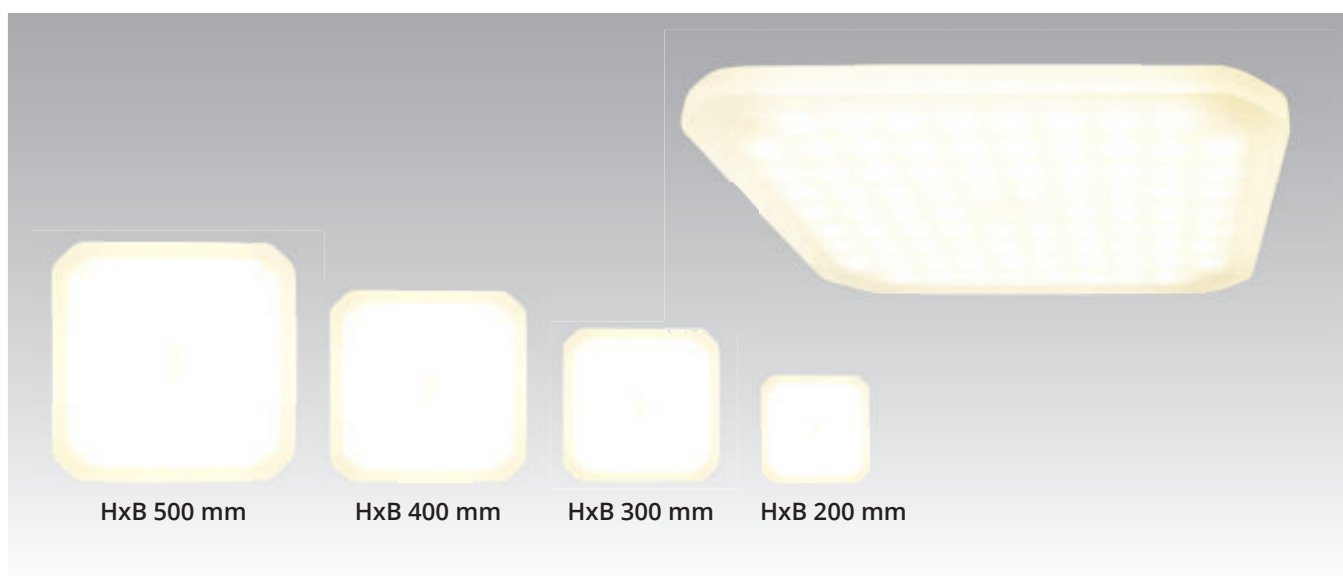

HxB 500 mm

HxB 400 mm

HxB 300 mm

HxB 200 mm

Foxx Cube 200/300/400/500 Outdoor Aufbauleuchte/surface mounting

Cube 200 x 200 mm LED G 10 Watt, ~2.700k ~700lm	Cube 300 x 300 mm LED G 14 Watt, ~2.700k ~1.260lm	Cube 400 x 400 mm LED G 22 Watt, ~2.700k ~1.980lm	Cube 500 x 500 mm LED G 33 Watt, ~2.700k ~2.970lm	Gehäuse body
7-47120010	7-47130010	7-47140010	7-47150010	aluminum anodized/ frosted solid acrylic



Foxx Cube Fit In200/300/400/500 Outdoor Einbauleuchte/recessed fitting

Cube 200 x 200 mm LED G 10 Watt, ~2.700k ~700lm	Cube 300 x 300 mm LED G 14 Watt, ~2.700k ~1.260lm	Cube 400 x 400 mm LED G 22 Watt, ~2.700k ~1.980lm	Cube 500 x 500 mm LED G 33 Watt, ~2.700k ~2.970lm	Gehäuse body
7-47220010	7-47230010	7-47240010	7-47250010	aluminum anodized/ frosted solid acrylic

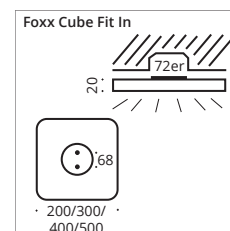
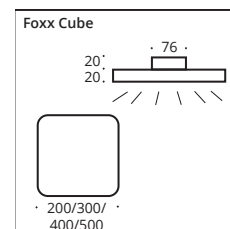

OUTDOOR

45





Foxx Round Outdoor \varnothing 200/300/400/500

Mit 20 mm ist die Round eine sensationell flache LED Deckenleuchte in den Durchmessern 200/300/400/500 mm. Als Auf- oder Einbauleuchte passt sie sich allen Stilrichtungen an. Mit der eingesetzten LED Hochvolttechnik heißt es nur noch »plug and light« für In- oder Outdoor (IP44).

With an unbelievable height of 20 mm the slim LED lamp can be mounted on ceilings. Diameter are available in 200/300/400/500 mm. As built-in or surface mounted luminaire for all kind of lighting requirements. With its high power LED assembly is as easy as possible. "Plug and light" for Indoor and Outdoor (IP44) areas.

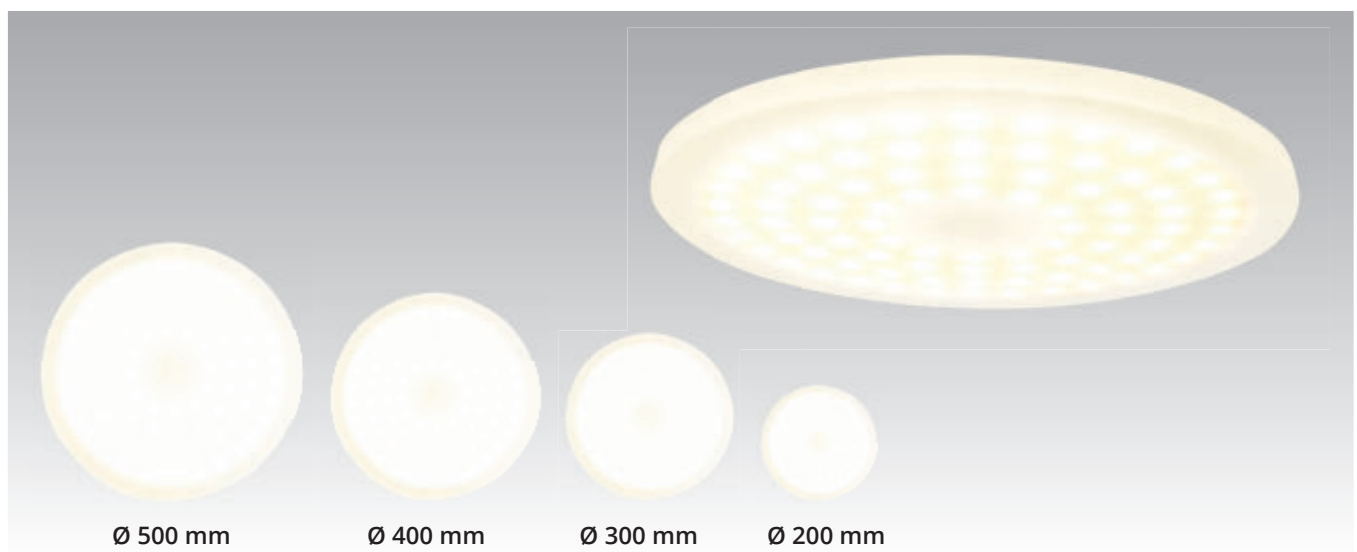

Foxx Round 200/300/400/500 Outdoor Aufbauleuchte/surface mounting

Round 200 mm \varnothing LED G 10 Watt, ~2.700k ~700lm	Round 300 mm \varnothing LED G 14 Watt, ~2.700k ~1.260lm	Round 400 mm \varnothing LED G 22 Watt, ~2.700k ~1.980lm	Round 500 mm \varnothing LED G 33 Watt, ~2.700k ~2.970lm	Gehäuse body
7-47320010	7-47330010	7-47340010	7-47350010	alueloxiert/ frosted solid acrylic



Foxx Round 200/300/400/500 Outdoor Fit In Einbauleuchte/recessed fitting

Round 200 mm \varnothing LED G 10 Watt, ~2.700k ~700lm	Round 300 mm \varnothing LED G 14 Watt, ~2.700k ~1.260lm	Round 400 mm \varnothing LED G 22 Watt, ~2.700k ~1.980lm	Round 500 mm \varnothing LED G 33 Watt, ~2.700k ~2.970lm	Gehäuse body
7-47420010	7-47430010	7-47440010	7-47450010	alueloxiert/ frosted solid acrylic

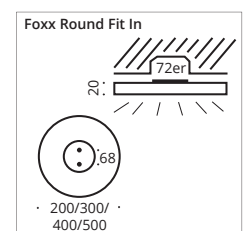
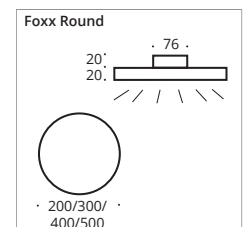

OUTDOOR



Puk Mini Wall Outdoor



Puk Mini Wall Outdoor \varnothing 80

LED Wandleuchte für den Außenbereich (IP44) mit up- & downlight aus Metall Spritzguß mit hochwertiger und robuster Feinstruktur Pulverbeschichtung. Optional können zu Linse oder Glas die Farbfilter dazu kombiniert werden.

LED wall luminaire for outdoor use (IP44) with up- and downlight. Made of metal injection moulding with high-quality and robust fine structure powder coating. Optionally, lens or glass as well as color filters can be combined.



white matt
fine structure

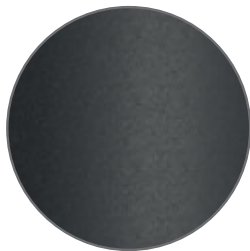

black matt
fine structure

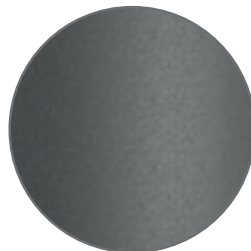

anthracite matt
fine structure

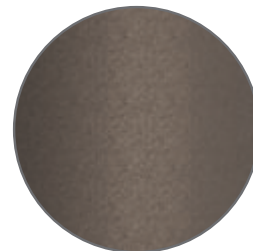

softbrown matt
fine structure

Puk Mini Wall Outdoor LED  ~2.700k 2 x 8W ~1.200lm	L x H in mm L x h in mm	Gehäuse body
2-48012-30	100 x 65	white matt, fine structure
2-48012-31	100 x 65	black matt, fine structure
2-48012-32	100 x 65	anthracite matt, fine structure
2-48012-33	100 x 65	softbrown matt, fine structure

- ▶ Ohne Zubehör. Bestell-Artikelnummern für Linsen, Gläser, Farbfilter und die Konfigurationsempfehlung auf der Einklappseite! 
- ▶ Without accessories: Order item-no. for lenses, glasses, color filters and the recommended Configuration are on the fold-in page!

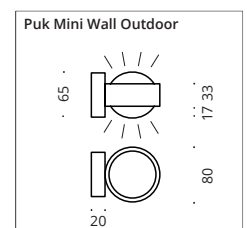

OUTDOOR





Puk Maxx Wall Outdoor \varnothing 120

Drehbare LED Wandleuchte für den Außenbereich (IP44) mit up- & downlight aus Metall Spritzguß mit hochwertiger und robuster Feinstruktur Pulverbeschichtung. Optional können zu Linse oder Glas die Farbfilter dazu kombiniert werden.

Rotatable LED wall luminaire for outdoor use (IP44) with up- and downlight. Made of metal injection moulding with high-quality and robust fine structure powder coating. Optionally, lens or glass as well as color filters can be combined.



white matt
fine structure

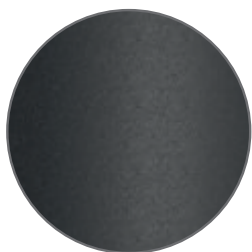

black matt
fine structure

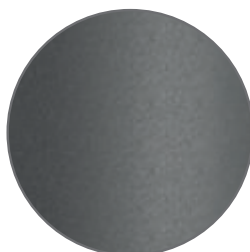

anthracite matt
fine structure

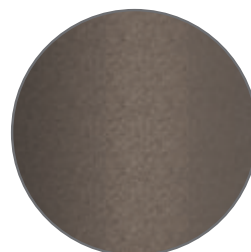

softbrown matt
fine structure

Puk Maxx Wall Outdoor LED G ~2.700k 2 x 8W ~1.200lm	L x H in mm L x h in mm	Gehäuse body
2-40812-30	140 x 80	white matt, fine structure
2-40812-31	140 x 80	black matt, fine structure
2-40812-32	140 x 80	anthracite matt, fine structure
2-40812-33	140 x 80	softbrown matt, fine structure

- ▶ Ohne Zubehör. Bestell-Artikelnummern für Linsen, Gläser, Farbfilter und die Konfigurationsempfehlung auf der Einklappseite!
- ▶ Without accessories: Order item-no. for lenses, glasses, color filters and the recommended Configuration are on the fold-in page!

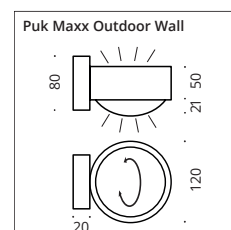

OUTDOOR





Puk Meg Maxx Wall Outdoor \varnothing 160

Drehbare LED Wandleuchte für den Außenbereich (IP44) mit up- & downlight aus Metall Spritzguß mit hochwertiger und robuster Feinstruktur Pulverbeschichtung. Optional können zu Linse oder Glas die Farbfilter dazu kombiniert werden.

Rotatable LED wall luminaire for outdoor use (IP44) with up- and downlight. Made of metal injection moulding with high-quality and robust fine structure powder coating. Optionally, lens or glass as well as color filters can be combined.



white matt
fine structure/chrome

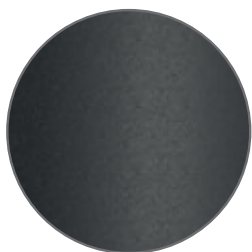

black matt
fine structure/chrome

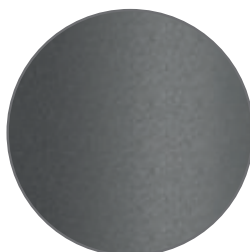

anthracite matt
fine structure/chrome

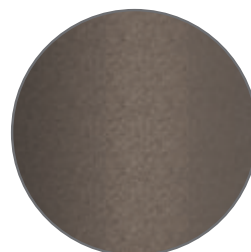

softbrown matt
fine structure/chrome

Puk Meg Maxx Wall Outdoor	L x H in mm L x H in mm	Gehäuse body
LED G ~2.700k 2 x 15W, ~3.000lm		
2-50812-30	185 x 80	white matt, fine structure/chrome
2-50812-31	185 x 80	black matt, fine structure/chrome
2-50812-32	185 x 80	anthracite matt, fine structure/chrome
2-50812-33	185 x 80	softbrown matt, fine structure/chrome

- ▶ Ohne Zubehör. Bestell-Artikelnummern für Linsen, Gläser, Farbfilter und die Konfigurationsempfehlung auf der Einklappseite!
- ▶ Without accessories: Order item-no. for lenses, glasses, color filters and the recommended Configuration are on the fold-in page!

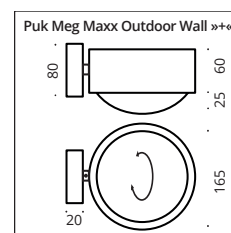

OUTDOOR





Puk Mini Way II Ø 80

Die Puk Mini Way II ist eine ideale Wegleuchte für Auffahrten, Eingänge und Wege oder einsetzbar als klassische Beetleuchte. Durch ihre Neigung leuchtet sie blendfrei direkt den Weg aus. Die hochwertige Feinstruktur-Haptik des VA-Gehäuses wird in eigener Manufaktur gepulvert und eingebrannt. Zusätzlich können optional zu Linse oder Glas die Farbfilter dazu kombiniert werden.

The Puk Mini Way II is an ideal light for driveways, entrances and paths or can be used as a classic patch light. Thanks to its inclination, it directly illuminates the path without glare. The high-quality fine-textured feel of the VA housing is powder-coated in our own manufactory. Optionally, lens or glass as well as color filters can be combined.

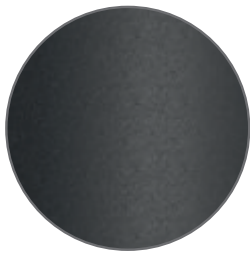

black matt
fine structure

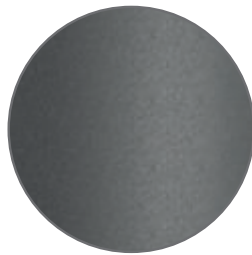

anthracite matt
fine structure

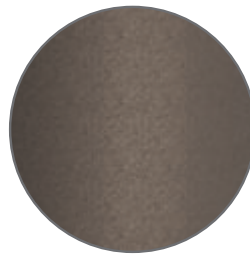

softbrown matt
fine structure



white matt
fine structure

Puk Mini Way II LED  ~2.700k 8W, ~600lm	H x B in mm H x B in mm	Ausführung design
15-4000-30	600 x 125	white matt, fine structure
15-4000-31	600 x 125	black matt, fine structure
15-4000-32	600 x 125	anthracite matt, fine structure
15-4000-33	600 x 125	softbrown matt, fine structure
15-4020	H 650	Erdanker

- ▶ Ohne Zubehör. Bestell-Artikelnummern für Linse, Glas, Farbfilter und die Konfigurationsempfehlung auf der Einklappseite! 
- ▶ Without accessories: Order item-no. for lens, glass, color filter and the recommended Configuration are on the fold-in page!

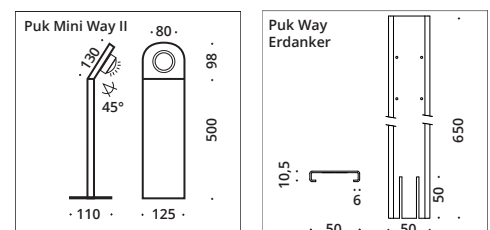

OUTDOOR



Puk Maxx Way II



Puk Maxx Way II Ø 120

Die Puk Max Way II ist eine ideale Wegleuchte für Auffahrten, Eingänge und Wege oder einsetzbar als klassische Beeleuchte. Durch ihre Neigung leuchtet sie blendfrei direkt den Weg aus. Die hochwertige Feinstruktur-Haptik des VA-Gehäuses wird in eigener Manufaktur gepulvert und eingebrannt. Zusätzlich können optional zu Linse oder Glas die Farbfilter dazu kombiniert werden.

The Puk Maxx Way II is an ideal light for driveways, entrances and paths or can be used as a classic patch light. Thanks to its inclination, it directly illuminates the path without glare. The high-quality fine-textured feel of the VA housing is powder-coated in our own manufactory. Optionally, lens or glass as well as color filters can be combined.

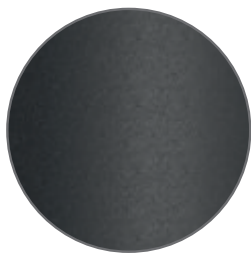

black matt
fine structure

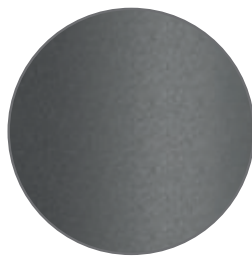

anthracite matt
fine structure

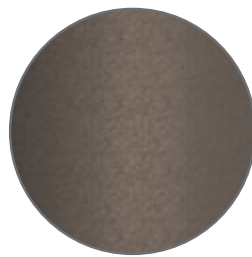

softbrown matt
fine structure



white matt
fine structure

Puk Maxx Way II	H x B in mm	Ausführung
LED ~2.700k 12W, ~1.800lm	H x B in mm	design
15-4001-30	600 x 125	white matt, fine structure
15-4001-31	600 x 125	black matt, fine structure
15-4001-32	600 x 125	anthracite matt, fine structure
15-4001-33	600 x 125	softbrown matt, fine structure
15-4020	H 650	Erdanker

- ▶ Ohne Zubehör. Bestell-Artikelnummern für Linse, Glas, Farbfilter und die Konfigurationsempfehlung auf der Einklappseite!
- ▶ Without accessories: Order item-no. for lens, glass, color filter and the recommended Configuration are on the fold-in page!

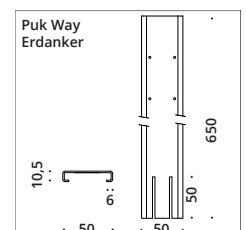
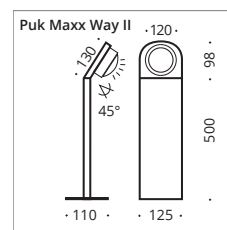

OUTDOOR





Octopus Outdoor Mini

Die lichtechten Schirme des Modells »Village« aus Polycarbonat leuchten in den Farben Gelb, Rot, Grün, Blau und Weiß. Die biegbaren Arme sind aus hochwertigem Kunststoff mit eingebettetem Alukern und in einer Standardlänge, sowie auf Maß, lieferbar. Der im Leuchtschaft integrierte Erdspieß ermöglicht es, den Schaft in das Erdreich zu stecken oder mit einem vorgestochenen Loch in den Boden einzulassen. Alle Metallteile sind aus hochwertigem, nichtrostendem VA-Stahl gefertigt und garantieren eine absolute Witterungsbeständigkeit der Leuchte.

The fadeless shades of the Village-model made of polycarbonate shine in colors of yellow, red, green, blue and white. The flexible arms are made of high-quality plastic with an embedded aluminium core and are available in a standard length as well as made to measure. The integrated groundskewer enables you to poke the lamp into the ground or to fix it in a pre-lanced hole. All metal parts are made of high-quality, stainless VA steel and guarantee absolute weather resistance of the luminaire.



yellow

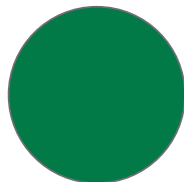

green

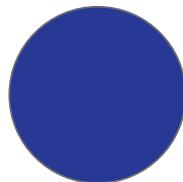

blue

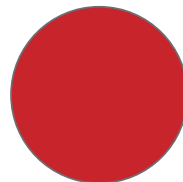

red

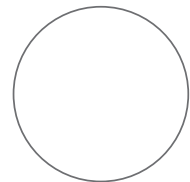

white



VA-Stahl-Spitze, Kunststoffschaf mit Aluminiumkern
Stainless steel tip, plastic shaft with aluminium core

E27 Fassung	Ausführung design	Maße in mm dimensions in mm
19-02130	Octopus Outdoor	1.300
19-10	Verlängerung, lengthening piece	je/each 100
● 19-02-GE	Village Mini Schirme/shades Schirm gelb, shade yellow	ø 150 - 300, 210
● 19-02-GR	Schirm grün, shade green	ø 150 - 300, 210
● 19-02-B	Schirm blau, shade blue	ø 150 - 300, 210
● 19-02-R	Schirm rot, shade red	ø 150 - 300, 210
○ 19-02-W	Schirm weiß, shade white	ø 150 - 300, 210
19-033	Einzelstabfuß	B x H x L 150
19-031	Betonfuß für 1-5 Leuchten	ø ca. 350 x H 150

Leuchtmittelempfehlung: LED Filamente E27/7W=60W/800lm/2.700K **G** Art. Nr. 8-331
 bulb recommendation: LED Filamente E27/7W=60W/800lm/2.700K **G** Item No. 8-331

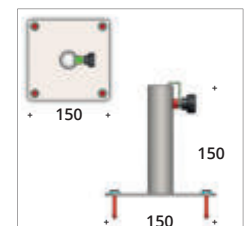
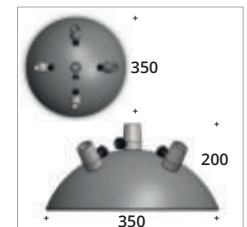
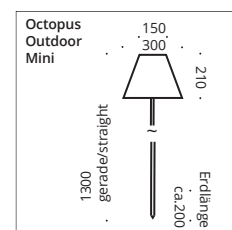

OUTDOOR





Octopus Outdoor

Die lichtechten Schirme des Modells »Village« aus Polycarbonat leuchten in den Farben Gelb, Rot, Grün, Blau und Weiß. Die biegbaren Arme sind aus hochwertigem Kunststoff mit eingebettetem Alukern und in zwei Standardlängen, sowie auf Maß, lieferbar. Der im Leuchtschaft integrierte Erdspieß ermöglicht es, den Schaft in das Erdreich zu stecken oder mit einem vorgestochenen Loch in den Boden einzulassen. Alle Metallteile sind aus hochwertigem, nichtrostendem VA-Stahl gefertigt und garantieren eine absolute Witterungsbeständigkeit der Leuchte.

The fadeless shades of the Village-model made of polycarbonate shine in colors of yellow, red, green, blue and white. The flexible arms are made of high-quality plastic with an embedded aluminium core and are available in two standard lengths as well as made to measure. The integrated groundskewer enables you to poke the lamp into the ground or to fix it in a pre-lanced hole. All metal parts are made of high-quality, stainless VA steel and guarantee absolute weather resistance of the luminaire.



yellow

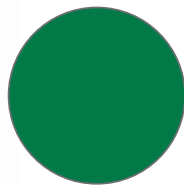

green

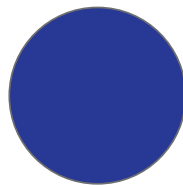

blue

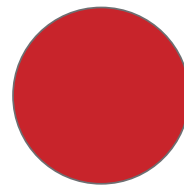

red

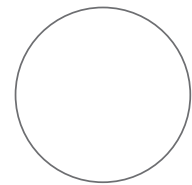

white



VA-Stahl-Spitze, Kunststoffschaft mit Aluminiumkern
Stainless steel tip, plastic shaft with aluminium core

E27 Fassung	Ausführung design	Maße in mm dimensions in mm
19-01130	Octopus Outdoor	1.700
19-01180	Octopus Outdoor	2.200
19-10	Verlängerung, lengthening piece	je/each 100
● 19-01-GE ● 19-01-GR ● 19-01-B ● 19-01-R ○ 19-01-W	Village Schirme/shades Schirm gelb, shade yellow Schirm grün, shade green Schirm blau, shade blue Schirm rot, shade red Schirm weiß, shade white	∅ 200 - 400, H 285 ∅ 200 - 400, H 285 ∅ 200 - 400, H 285 ∅ 200 - 400, H 285 ∅ 200 - 400, H 285
19-0111	Big Foot Objektfuß für max. 11 Leuchten base for max 11 lamps	∅ ca. 400 3 x Erdspieß / spike L=500 Edelstahl / stainless steel
19-033	Einzelstandfuß	B x H x L 150
19-031	Betonfuß für 1-5 Leuchten	∅ ca. 350 x H 150

Bei der Abnahme von 7 Octopus Outdoor Leuchten gibt es den Big Foot kostenlos dazu.
With purchasing 7 Octopus Outdoor lamps you get a Big Foot additionally for free.

Leuchtmittelpfehlung: LED Filamente E27/7W=60W/800lm/2.700K **G** Art. Nr. 8-331
bulb recommendation: LED Filamente E27/7W=60W/800lm/2.700K **G** Item No. 8-331

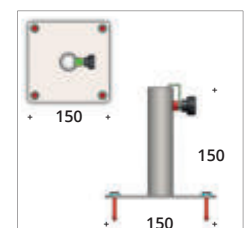
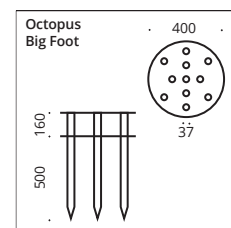
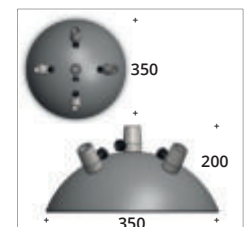
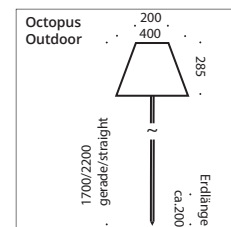

OUTDOOR

Light Stone

Wegweisende und dekorative Lichtelemente im Pflaster.
Pioneering and decorative light elements in the patch.

Der original Light Stone Pflasterstein ist die konsequente Umsetzung der Hochleistungs-LED-Technik. In Beton-, Basalt- oder Granitsteinoptik und in verschiedenen Größen fügt er sich als Wegweiser oder dekoratives Lichtelement in alle Pflasterflächen ein.

The original Light Stone cobblestone is the perfect realisation of high performance LED technology. In concrete, basalt or granite stone design and in different sizes it blends in perfectly with all cobblestone surfaces as guidelight or decorative light element.



Modell-/Formatübersicht Survey of formats and models

Beton

Kunststeinoptik, Cast Stone Design
Maße (Dimensions) in mm

B x L x H (w x l x h)
60 x 60 x 80
80 x 80 x 80
100 x 100 x 60
100 x 200 x 60



Basalt

Natursteinoptik, Virgin Stone Design
Maße (Dimensions) in mm

B x L x H (w x l x h)
50 x 60 x 50
60 x 70 x 60
70 x 85 x 70
120 x 120 x 80
140 x 140 x 80
160 x 160 x 90

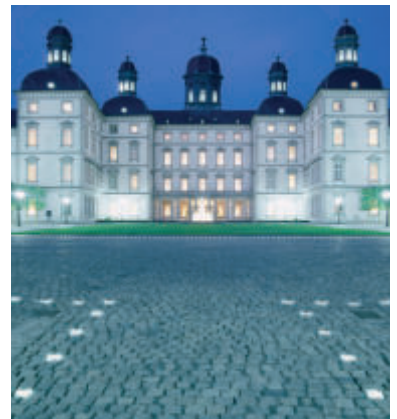

Cristal

Granitsteinoptik, Granite Stone Design
Maße (Dimensions) in mm

B x L x H (w x l x h)
50 x 60 x 50
60 x 70 x 55
70 x 80 x 70
95 x 95 x 60



Technik Technology LED **G** ~5.300k, IP68

- | | | |
|---|--------------------|--------|
| ① | 0,3 Watt LED ~19lm | 12V/DC |
| ② | 1 Watt LED ~81lm | 12V/DC |



Lichtstein-
montage:

Lightstone
mounting:

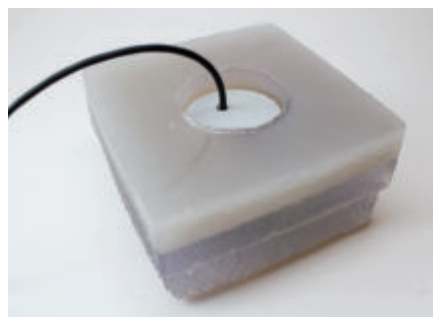
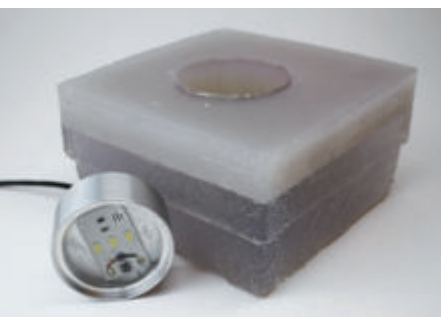

Neue Lichtstein LED Technologie.

Unsere Lichtsteine verfügen jetzt über ein separat geschütztes System mit komplett vergossener LED. Dadurch wird eine extreme Wasserdichte im IP68 Bereich gewährleistet, die den Lichtstein noch resistenter gegen Abnutzung durch Umwelteinflüsse macht.

New Lightstone LED Technologie.

Our lightstones now have a separately protected system with fully encapsulated LED. As a result, an extreme IP68 water density is ensured, that makes the lightstone more resistant to wear and tear caused by environmental factors.

Qualitätssicherung

Eine Gewährleistung für eine langlebige Funktion unserer Lichtsteine gilt nur bei Verwendung der original Top Light Zubehörteile (Transformator = spannungsstabil und Verbinder = kapillarwirkungsresistent). Bei Verwendung von Zubehörteilen anderer Hersteller erlischt jegliche Garantie.

Quality assurance

A guarantee for a long-lasting function of our lightstones is only valid when original Top Light accessories are used (transformer = voltage stable and connector = capillary action resistant). The use of accessories from other manufacturers will void any warranty.





Light Stone Beton

Pflasterstein, Kunststeinoptik mit Anprallschutz, Hochleistungs LED-technik, ca. 0,3 oder 1 Watt, 12 V-DC, befahrbar (private Auffahrt/Fußgängerzone), schlagzäh, lichtstabilisiert. Die LightStones werden „made in Germany“ bei uns im Haus einzeln in Formen gegossen.

Paving stone, artificial stone look with impact protection, high-power LED technology, approx. 0.3 or 1 Watt, 12 V-DC, trafficable (private driveway/pedestrian zone), impact-resistant, light-stabilised. The LightStones are "made in Germany" and cast individually in moulds at our factory.



Mit individuellem Logo auf Anfrage. With individual logo on request.



Art. Nr. item no.	Leistung output 0,3 Watt	Art. Nr. item no.	Leistung output 1 Watt	L x B x H in mm l x w x h in mm	Farbe color
12-016060	1 x 0,3 Watt	12-016060+	1 x 1 Watt	60 x 60 x 80 ^①	glasklar, crystal clear
12-018080	1 x 0,3 Watt	12-018080+	1 x 1 Watt	80 x 80 x 80 ^①	glasklar, crystal clear
12-01100100	1 x 0,3 Watt	12-01100100+	1 x 1 Watt	100 x 100 x 60 ^②	glasklar, crystal clear
12-01100200	2 x 0,3 Watt	12-01100200+	1 x 1 Watt	100 x 200 x 60 ^②	glasklar, crystal clear



① Maße beziehen sich auf Leuchtenkörper (sichtbare Fläche), Aufprallschutz + 5 mm.

Dimensions relate to illuminant (visible area), impact protection + 5 mm.

② Sollmaße für Standart Betonrechteck Pflaster 10 x 10 bzw. 10 x 20. Nominal dimensions for standard concrete rectangle cobblestone 10 x 10 or 10 x 20.

Zubehör für die Verlegung finden Sie auf Seite 463.
Accessories for installation can be found on page 463.

OUTDOOR





Light Stone Basalt

Pflasterstein, Natursteinoptik mit Anprallschutz, Hochleistungs LED-Technik, ca. 0,3 oder 1 Watt, 12 V-DC, befahrbar (private Auffahrt/Fußgängerzone), schlagzäh, lichtstabilisiert. Die LightStones werden „made in Germany“ bei uns im Haus einzeln in Formen gegossen.

Paving stone, natural stone optic with impact protection, high-performance LED technology, approx. 0.3 or 1 Watt, 12 V-DC, trafficable (private driveway/pedestrian zone), impact-resistant, light-stabilised. The LightStones are "made in Germany" and cast individually in moulds at our factory.

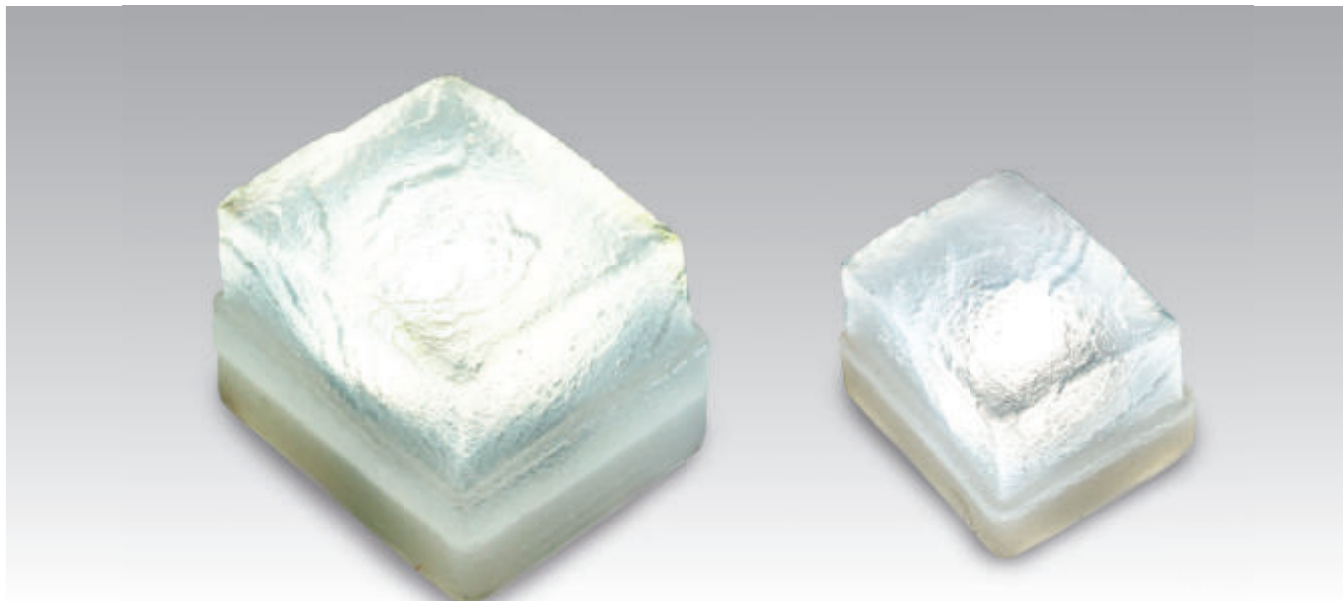

Problemloses Verlegen, erdeinbautaugliches Elektroequipment (IP68) und die extrem lange Brenndauer (mittlere Brennstunden), zeichnen den Light Stone aus!

Problem-free installation, electronic equipment fit for subsurface installation (IP68) and the extremely long lighting hours (average lighting hours) are what the Light Stone stands for!

Art. Nr. item no.	Leistung output 0,3 Watt	Art. Nr. item no.	Leistung output 1 Watt	L x B x H in mm l x w x h in mm	Farbe color
11-015060	1 x 0,3 Watt	11-015060+	1 x 1 Watt	50 x 60 x 50 ^①	glasklar, crystal clear
11-016070	1 x 0,3 Watt	11-016070+	1 x 1 Watt	60 x 70 x 60 ^①	glasklar, crystal clear
11-017085	1 x 0,3 Watt	11-017085+	1 x 1 Watt	70 x 85 x 70 ^①	glasklar, crystal clear
11-01120120	2 x 0,3 Watt	11-01120120+	2 x 1 Watt	120 x 120 x 80 ^①	glasklar, crystal clear
11-01140140	4 x 0,3 Watt	11-01140140+	4 x 1 Watt	140 x 140 x 80 ^①	glasklar, crystal clear
11-01160160	4 x 0,3 Watt	11-01160160+	4 x 1 Watt	160 x 160 x 80 ^①	glasklar, crystal clear



① Maße beziehen sich auf Leuchtenkörper (sichtbare Fläche), Aufprallschutz + 5 mm.
Dimensions relate to illuminant (visible area), impact protection + 5 mm.

Zubehör für die Verlegung finden Sie auf Seite 463.
Accessories for installation can be found on page 463.





Light Stone Cristal

Pflasterstein, Granitsteinoptik, Hochleistungs LED-Technik, ca. 0,3 Watt oder 1Watt, 12 V-DC, befahrbar (private Auffahrt/ Fußgängerzone), schlagzäh, lichtstabilisiert. Die LightStones werden „made in Germany“ bei uns im Haus einzeln in Formen gegossen.

Paving stone, granite look with impact protection, high-performance LED technology, approx. 0.3 or 1 Watt, 12 V-DC, trafficable (private driveway/pedestrian zone), impact-resistant, light-stabilised. The LightStones are "made in Germany" and cast individually in moulds at our factory.

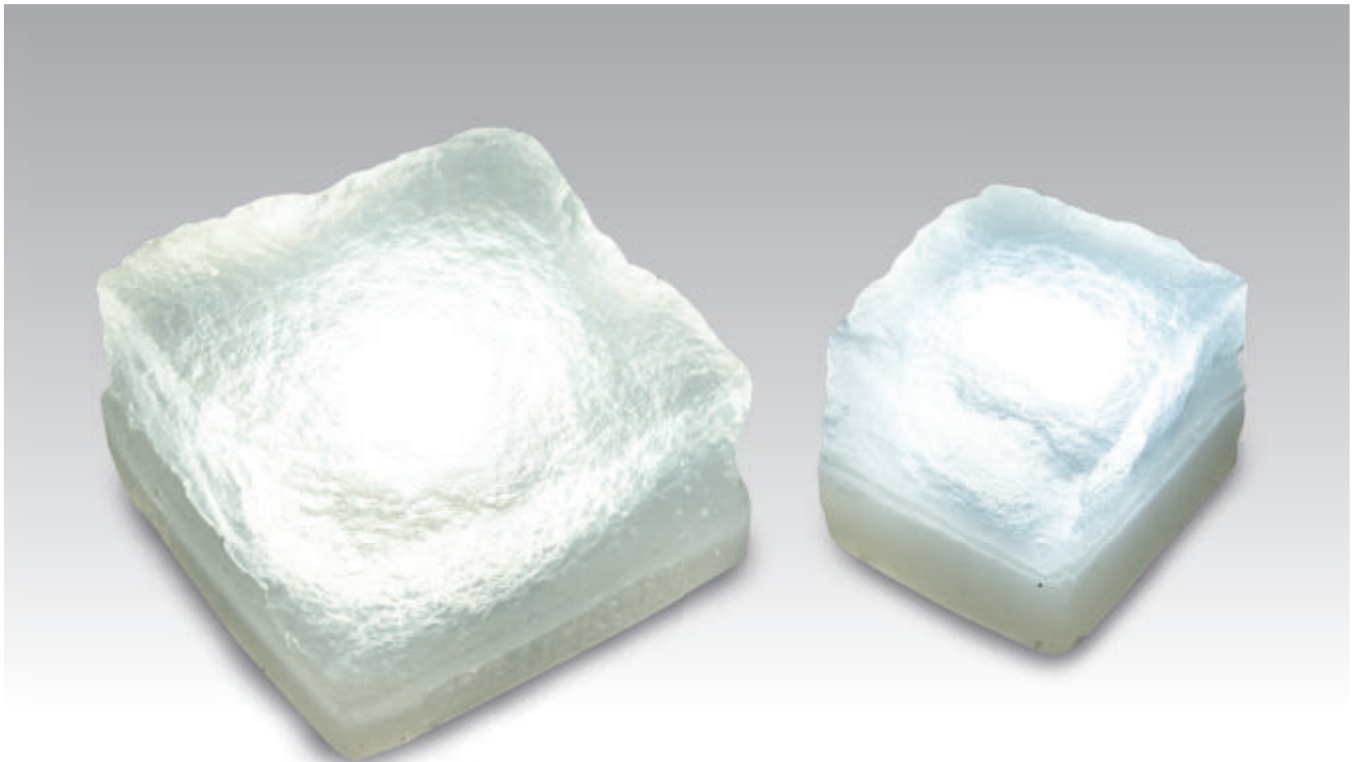

Art. Nr. item no.	Leistung output 0,3 Watt	Art. Nr. item no.	Leistung output 0,3 Watt	L x B x H in mm l x w x h in mm	Farbe color
16-015060	1 x 0,3 Watt	16-015060+	1 x 1 Watt	50 x 60 x 50 [Ⓞ]	glasklar, crystal clear
16-016070	1 x 0,3 Watt	16-016070+	1 x 1 Watt	60 x 70 x 55 [Ⓞ]	glasklar, crystal clear
16-017090	1 x 0,3 Watt	16-017090+	1 x 1 Watt	70 x 80 x 70 [Ⓞ]	glasklar, crystal clear
16-01100100	1 x 0,3 Watt	16-01100100+	1 x 1 Watt	95 x 95 x 60 [Ⓞ]	glasklar, crystal clear



Ⓞ Maße beziehen sich auf Leuchtenkörper (sichtbare Fläche). Dimensions relate to illuminant (visible area), impact protection + 5 mm.

Zubehör für die Verlegung finden Sie auf Seite 463.
Accessories for installation can be found on page 463.

OUTDOOR



Technisches Zubehör Technical accessories

Artikel model	Art. Nr. item no.	Ausführung design 2-polig Niedervolt, schwarz 2-pin for low voltage, black	L x B x H l x w x h
10 m Erdgummikabel	13-01010	2-polig für NV, schwarz, 2-pin for low voltage, black	10 m, 0, 75 qmm
25 m Erdgummikabel	13-01025	2-polig für NV, schwarz, 2-pin for low voltage, black	25 m, 0, 75 qmm
50 m Erdgummikabel	13-01050	2-polig für NV, schwarz, 2-pin for low voltage, black	50 m, 0, 75 qmm
100 m Erdgummikabel	13-01100	2-polig für NV, schwarz, 2-pin for low voltage, black	100 m, 0, 75 qmm
Kabelverbinder-Set cable connector set	13-01105	Kabelverbinder-Set, 1x pro Stein/LED cable connector set, 1x per stone/LED IP 68, 13 cm (5 Teile/ 5 parts)	
Trafo 7 Watt, IP 65 + Box transformator 7 watts + box	13-01102	inkl. Trafo und Box, incl. transformator and cable resin max. 7 Steine bei 1W, max. 21 Steine bei 0,3 W, max. 7 1W-stones, max. 21 0,3W-stones Parallel-Schaltung, parallel switching	93 x 93 x 62 mm
Trafo 20 Watt, IP 65 + Box transformator 20 watts + box	13-01104	inkl. Trafo und Box, incl. transformator and box max. 20 Steine bei 1W, max. 60 Steine bei 0,3 W max. 20 1W-stones, max. 60 0,3W-stones Parallel-Schaltung, parallel switching	130 x 130 x 77 mm



Qualitätssicherung

Eine Gewährleistung für eine langlebige Funktion unserer Lichtsteine gilt nur bei Verwendung der Original Top Light Zubehöerteile (Transformator = spannung stabil und Verbinder = kapillarwirkungsresistent). Bei Verwendung von Zubehörteilen anderer Hersteller erlischt jegliche Garantie.

Gezeigte Lichtstein-Farben sind ein Hinweis auf das optische Finish und keine Eigenschaftszusicherung. Für die Richtigkeit von technischen Angaben, sowie Farbabweichungen wird keine Gewähr übernommen. Alle Maßangaben sind unverbindlich und können geringfügige Abweichungen aufweisen. Technische Änderungen vorbehalten.

Die Qualitätsmerkmale des Light Stone werden auch Sie überzeugen:

- Lange Brenndauer durch neueste LED-Technik
- 3 verschiedene Systeme: Basaltpflaster, Betonpflaster, Granitpflaster
- Versch.Standardgrößen: 6 Basalt-, 4 Beton-, 4 Granit-Größen
- Erdeinbautauglich: Light Stone und hochwertiges Installationsmaterial nach Schutzklasse IP 68 und IP 58 kann ohne Spezialwerkzeug problemlos verlegt werden
- Grundkörper mineralstoffbefüllt, seitlicher Anprallschutz: Light Stone kann im Verbund mit anderem Pflaster verlegt werden
- Hoher optischer und haptischer Anspruch; Basalt mit natursteinartiger Topographie und Oberfläche, Betonfarben mit hochbeständiger Granulatbeschichtung, Granit in Naturoptik.
- Durch Rechteckformate mit unterschiedlichen Kantenlängen gute Einfassung in den Pflasterverbund
- Hervorragendes Preis-/Leistungsverhältnis durch langjährige Erfahrungen und Innovationskraft in der Kunstharzverarbeitung in eigener Manufaktur
- Lichtstabilisiert und schlagzäh
- Systemprodukt: Sortimentsausbau durch Zubehör und Wegeleuchten
- Sondergrößen und -ausführungen in Stückzahlen für Objektausstattungen wie Altstadt-pflaster oder Industriebau
- Rutschfestigkeitsklasse 3V (sehr hoher Haftreibungswert, Trittsicherheitswinkel über 35,1° mit hohem Schmutzverdrängungsraum)
- Keine Abstrahlung von UV-Licht
- Geringe Temperaturentwicklung am Leuchtmittel
- Auf ca. 40 m verlegbar ohne Spannungsverlust, 2-polig, 12V-DC, Parallel-Schaltung

Quality assurance

A guarantee for a long-lasting function of our lightstones is only valid when original Top Light accessories are used (transformer = voltage stable and connector = capillary action resistant). The use of accessories from other manufacturers will void any warranty.

Shown Lightstone colors are an indication of the optical design and no confirmation of character. No responsibility is taken for the correctness of technical data and alterations of color. All dimensions are non-committal and can be subject to minor deviations. Technical changes are subject to alteration.

Let the quality features of the Light Stone persuade you:

- Long lighting hours with new LED-technology.
- Three different systems: Basalt cobblestones, concrete cobblestones, granite cobblestones
- Different standard sizes: 6 basalt sizes, 4 concrete sizes, 4 granite sizes
- Suitable for subsurface fitting: Light Stone and high grade installation material according to protection category IP 68 and IP 58. Can be easily installed without specialty tools
- Base body filled with mineral compound, lateral impact protection: Light Stone can be installed together with other cobblestones
- High optical and haptic standard, basalt stone with virgin stone-like topography and surface, concrete colored with highly stable granules coating, granite in natural look
- Optimum integration in the cobblestone compound through rectangular formats with different edge lengths
- Extraordinary price-performance through our long-term experience in synthetic resin finish in our own factory
- Light stabilised and impact resistant
- System product: A steady expansion of our product line by accessories and pathlights
- Special sizes and designs in quantities for object furnishing like old town pavement or industrial construction
- Skid resistance category 3V (high friction value, slip resistance angle more than 35,1 with large dirt displacement space)
- No radiance of UV light
- Small temperature development
- Layable at 40 m without power loss, 2-pin, 12V-DC, parallel switching



Verkaufs-, Liefer- und Zahlungsbedingungen der Top Light GmbH & Co. KG

- Version: Januar 2020 -

I. Allgemeine Bestimmungen

1. Für die Rechtsbeziehungen zwischen der Top Light GmbH & Co. KG und einem Besteller im Zusammenhang mit den Lieferungen und/oder Leistungen der Top Light GmbH & Co. KG (im Folgenden: Lieferungen) gelten ausschließlich diese Verkaufs-, Liefer- und Zahlungsbedingungen. Allgemeine Geschäftsbedingungen des Bestellers gelten nur insoweit, als die Top Light GmbH & Co. KG ihnen ausdrücklich schriftlich zugestimmt hat. Für den Umfang der Lieferungen sind die beiderseitigen übereinstimmenden schriftlichen Erklärungen maßgebend.
2. An Kostenvorschlägen und anderen Unterlagen (im Folgenden: Unterlagen) behält sich die Top Light GmbH & Co. KG ihre eigentums- und urheberrechtlichen Verwertungsrechte uneingeschränkt vor. Die Unterlagen dürfen nur nach vorheriger Zustimmung der Top Light GmbH & Co. KG Dritten zugänglich gemacht werden und sind, wenn der Auftrag der Top Light GmbH & Co. KG nicht erteilt wird, dieser auf Verlangen unverzüglich zurückzugeben. Die Sätze 1 und 2 gelten entsprechend für Unterlagen des Bestellers; diese dürfen jedoch solchen Dritten zugänglich gemacht werden, denen die Top Light GmbH & Co. KG zulässigerweise Lieferungen übertragen hat.
3. Teillieferungen sind zulässig, soweit sie dem Besteller zumutbar sind.
4. Der Begriff „Schadensersatzansprüche“ in diesen Verkaufs-, Liefer- und Zahlungsbedingungen umfasst auch Ansprüche auf Ersatz vergeblicher Aufwendungen.
5. Die Angebote der Top Light GmbH & Co. KG sind freibleibend. Ein Vertrag kommt erst durch schriftliche Auftragsbestätigung der Top Light GmbH & Co. KG wirksam zustande.
6. Alle in unseren Katalogen, Listen, Zeichnungen und sonstigen Verkaufsunterlagen enthaltenen technischen Daten sind sorgfältig und nach bestem Wissen erstellt. Änderungen, die dem Fortschritt dienen, behält Top Light GmbH & Co. KG auch nach Versand der Auftragsbestätigung vor, soweit dadurch nicht Preis, Funktion oder Lieferzeit beeinträchtigt werden.

II. Preise, Zahlungsbedingungen und Aufrechnung

1. Die Preise verstehen sich in EURO ab Werk ausschließlich Verpackung zuzüglich der jeweils geltenden gesetzlichen Umsatzsteuer.
2. Bei Bestellungen aus unserem Leuchtenportfolio von einem Warenwert über € 500,- netto, liefert die Top Light GmbH & Co. KG fracht- und verpackungsfrei an eine Empfangsstation bzw. Versandadresse innerhalb der Bundesrepublik Deutschland. Bei Bestellungen aus unserem Spiegelportfolio fallen bei jeder Lieferung Kosten an, die mit dem Angebot bzw. der Auftragsbestätigung der Top Light GmbH & Co. KG angegeben werden.
3. Bei Abweichung der Lieferanschrift von der Rechnungsanschrift erhebt die Top Light GmbH & Co. KG eine Pauschale pro abweichender Lieferadresse in Höhe von 8,00 € netto zzgl. Mehrwertsteuer.
4. Rechnungen werden frühestens am Tag der Lieferung ausgestellt. Bei Zahlung innerhalb von 10 Tagen nach Rechnungsdatum wird ein Skonto von 2 % gewährt. Das offene Ziel beträgt 30 Tage. Bei Erteilung eines Abbuchungsauftrages gewähren wir 3 % Skonto. Dabei werden die Rechnungen am 10. des Folgemonats für den Vormonat eingezogen.
5. Erstlieferungen an Neukunden erfolgen grundsätzlich gegen Nachnahme. Lieferungen außerhalb der Bundesrepublik Deutschland erfolgen grundsätzlich gegen Netto- Vorauszahlung.
6. Für Sonderanfertigungen und Bestellungen über € 5.000,- wird die Hälfte der Rechnungssumme bei Auftragserteilung fällig. Sonderanfertigungen sind vom Rücktritt des Bestellers ausgeschlossen.
7. Befindet sich der Besteller im Zahlungsverzug ist die Top Light GmbH & Co. KG berechtigt, bis zur vollständigen Bezahlung der im Verzug befindlichen Rechnung einschließlich der angefallenen Verzugszinsen die Lieferung weiterer Waren aus irgendeinem laufenden Vertrag zurückzuhalten (Zurückbehaltungsrecht).
8. Zahlungen sind frei Zahlstelle der Top Light GmbH & Co. KG zu leisten.
9. Der Besteller kann nur mit solchen Forderungen aufrechnen, die unbestritten oder rechtskräftig festgestellt sind.
10. Muster können von der Top Light GmbH & Co. KG für die Dauer von drei Wochen kostenfrei zur Verfügung gestellt werden. Muster müssen in der Bestellung ausdrücklich als solche bezeichnet werden. Die Berechnung der Muster erfolgt auf der Grundlage der zum Zeitpunkt der Berechnung gültigen Verkaufspreise und Lieferbedingungen (Kauf auf Probe). Der Besteller ist berechtigt, innerhalb dieser drei Wochen vom Kauf der Muster zurückzutreten. Im Falle des Rücktritts sendet der Besteller die Muster unaufgefordert „frei Haus“ zurück und hat dafür Sorge zu tragen, dass die Ware in mangelfreiem Zustand wieder übergeben wird. In diesem Fall wird über den Kaufpreis der Muster ausschließlich der Fracht und Verpackung für das Versenden der Muster an den gewünschten Empfangsort (Lieferort) eine Gutschrift erstellt. Befindet sich die zurückgesandte Ware nicht in mangelfreiem Zustand, hat der Besteller Schadensersatz in Höhe des Bestellwertes zu leisten.
11. Soweit die Top Light GmbH & Co. KG aus Kulanz Waren zurücknimmt, erfolgt dies nur gegen Zahlung einer Bearbeitungsgebühr in Höhe von 30% des Kaufpreises netto pauschal zzgl. gesetzlicher Umsatzsteuer.

III. Eigentumsvorbehalt

1. Die Gegenstände der Lieferungen (Vorbehaltsware) bleiben Eigentum der Top Light GmbH & Co. KG bis zur Erfüllung sämtlicher ihr gegen den Besteller aus der Geschäftsverbindung zustehenden Ansprüche. Soweit der Wert aller Sicherungsrechte, die der Top Light GmbH & Co. KG zustehen, die Höhe aller gesicherten Ansprüche um mehr als 10% übersteigt, wird die Top Light GmbH & Co. KG auf Wunsch des Bestellers einen entsprechenden Teil der Sicherungsrechte freigeben; der Top Light GmbH & Co. KG steht die Wahl bei der Freigabe zwischen verschiedenen Sicherungsrechten zu.
2. Während des Bestehens des Eigentumsvorbehalts ist dem Besteller eine Verpfändung oder Sicherungsübereignung untersagt und die Weiterveräußerung nur Wiederverkäufern im gewöhnlichen Geschäftsgang und nur unter der Bedingung gestattet, dass der Wiederverkäufer von seinem Kunden Bezahlung erhält oder den Vorbehalt macht, dass das Eigentum auf den Kunden erst übergeht, wenn dieser seine Zahlungsverpflichtungen erfüllt hat.
3. Veräußert der Besteller Vorbehaltsware weiter, so tritt er bereits jetzt seine künftigen Forderungen aus der Weiterveräußerung gegen seine Kunden mit allen Nebenrechten - einschließlich etwaiger Saldoforderungen - sicherungshalber an die Top Light GmbH & Co. KG ab, ohne dass es weiterer besonderer Erklärungen bedarf. Wird die Vorbehaltsware zusammen mit anderen Gegenständen weiter veräußert, ohne dass für die Vorbehaltsware ein Einzelpreis vereinbart wurde, so tritt der Besteller denjenigen Teil der Gesamtpreisforderung an die Top Light GmbH & Co. KG ab, der dem von der Top Light GmbH & Co. KG in Rechnung gestellten Preis der Vorbehaltsware entspricht.
4. Geht das Vorbehaltswareigentum der Top Light GmbH & Co. KG wegen Einbaus/Verarbeitung unter, tritt der Besteller die ihm insoweit zustehenden Ersatzansprüche gegen seine Abnehmer oder Dritte in Höhe der gemäß Ziff. 1 ausstehenden Zahlungsverpflichtungen an die Top Light GmbH & Co. KG ab.
5. Bis auf Widerruf ist der Besteller zur Einziehung abgetretener Forderungen aus der Weiterveräußerung befugt. Bei Vorliegen eines wichtigen Grundes, insbesondere bei Zahlungsverzug, Zahlungseinstellung, Eröffnung eines Insolvenzverfahrens, Wechselprotest oder begründeten Anhaltspunkten für eine Überschuldung oder drohende Zahlungsunfähigkeit des Bestellers, ist die Top Light GmbH & Co. KG berechtigt, die Einziehungsermächtigung des Bestellers zu widerrufen. Außerdem kann die Top Light GmbH & Co. KG nach vorheriger Androhung unter Einhaltung einer angemessenen Frist die Sicherungsabtretung offenlegen, die abgetretenen Forderungen verwerten sowie die Offenlegung der Sicherungsabtretung durch den Besteller gegenüber dem Kunden verlangen.
6. Die Top Light GmbH & Co. KG ist berechtigt, die Sicherungsabtretung offen zu legen, die abgetretenen Forderungen zu verwerten sowie die Offenlegung der Sicherungsabtretung durch den Besteller gegenüber dem Kunden zu verlangen. Der Besteller hat der Top Light GmbH & Co. KG auf Verlangen die abgetretenen Forderungen und deren Schuldner offen zu legen.
7. Bei Pfändungen, Beschlagnahmen oder sonstigen Verfügungen oder Eingriffen Dritter hat der Besteller die Top Light GmbH & Co. KG unverzüglich zu benachrichtigen. Bei Glaubhaftmachung eines berechtigten Interesses hat der Besteller der Top Light GmbH & Co. KG die zur Geltendmachung seiner Rechte gegen den Kunden erforderlichen Auskünfte zu erteilen und die erforderlichen Unterlagen auszuhandigen.
8. Bei Pflichtverletzungen des Bestellers, insbesondere bei Zahlungsverzug, ist die Top Light GmbH & Co. KG nach erfolglosem Ablauf einer dem Besteller gesetzten angemessenen Frist zur Leistung neben der Rücknahme auch zum Rücktritt berechtigt; die gesetzlichen Bestimmungen über die Entbehrlichkeit einer Fristsetzung bleiben unberührt. Der Besteller ist zur Herausgabe verpflichtet. In der Rücknahme bzw. der Geltendmachung des Eigentumsvorbehalts oder der Pfändung der Vorbehaltsware durch die Top Light GmbH & Co. KG liegt kein Rücktritt vom Vertrag, es sei denn die Top Light GmbH & Co. KG hätte dies ausdrücklich erklärt.

IV. Fristen für Lieferungen; Verzug

1. Leistungsort der Top Light GmbH & Co. KG ist Spenge.
2. Die Einhaltung von Fristen für Lieferungen setzt den rechtzeitigen Eingang sämtlicher vom Besteller zu liefernden Unterlagen, sowie die Einhaltung der vereinbarten Zahlungsbedingungen und sonstigen Verpflichtungen durch den Besteller voraus. Werden diese Voraussetzungen nicht rechtzeitig erfüllt, so verlängern sich die Fristen angemessen; dies gilt nicht, wenn die Top Light GmbH & Co. KG die Verzögerung zu vertreten hat.
3. Ist die Nichteinhaltung der Fristen auf höhere Gewalt, z. B. Mobilmachung, Krieg, Aufruhr, oder auf ähnliche Ereignisse, z. B. Streik, Aussperrung, zurückzuführen, verlängern sich die Fristen angemessen. Gleiches gilt für den Fall der nicht rechtzeitigen oder ordnungsgemäßen Belieferung der Top Light GmbH & Co. KG.
4. Kommt die Top Light GmbH & Co. KG in Verzug, kann der Besteller - sofern er glaubhaft macht, dass ihm hieraus ein Schaden entstanden ist - eine Entschädigung für jede vollendete Woche des Verzuges von je 0,5%, insgesamt jedoch höchstens 5% des Preises für den Teil der Lieferungen verlangen, der wegen des Verzuges nicht in zweckdienlichen Betrieb genommen werden konnte.

- Sowohl Schadensersatzansprüche des Bestellers wegen Verzögerung der Lieferung als auch Schadensersatzansprüche statt der Leistung, die über die in Nr. 3 genannten Grenzen hinausgehen, sind in allen Fällen verzögerter Lieferung, auch nach Ablauf einer der Top Light GmbH & Co. KG etwa gesetzten Frist zur Lieferung, ausgeschlossen. Dies gilt nicht, soweit in Fällen des Vorsatzes, der groben Fahrlässigkeit oder wegen der Verletzung des Lebens, des Körpers oder der Gesundheit zwingend gehaftet wird. Vom Vertrag kann der Besteller im Rahmen der gesetzlichen Bestimmungen nur zurücktreten, soweit die Verzögerung der Lieferung von der Top Light GmbH & Co. KG zu vertreten ist. Eine Änderung der Beweislast zum Nachteil des Bestellers ist mit den vorstehenden Regelungen nicht verbunden.
- Der Besteller ist verpflichtet, auf Verlangen der Top Light GmbH & Co. KG innerhalb einer angemessenen Frist zu erklären, ob er wegen der Verzögerung der Lieferung vom Vertrag zurücktritt oder auf der Lieferung besteht. Nach Ablauf der Frist ist die Top Light GmbH & Co. KG berechtigt, bezüglich des ausstehenden Teils der Lieferung vom Vertrag zurückzutreten oder vom Vertrag in Gänze zurückzutreten.
- Werden Versand oder Zustellung auf Wunsch des Bestellers um mehr als einen Monat nach Anzeige der Versandbereitschaft verzögert, kann dem Besteller für jeden weiteren angefangenen Monat Lagergeld in Höhe von 0,5% des Preises der Gegenstände der Lieferungen, höchstens jedoch insgesamt 5%, berechnet werden. Der Nachweis höherer oder niedrigerer Lagerkosten bleibt den Vertragsparteien unbenommen.

V. Gefahrübergang

- Der Versand erfolgt auf Gefahr und Risiko des Bestellers.
- Die Gefahr geht auch bei frachtfreier Lieferung auf den Besteller über, wenn sie zum Versand gebracht oder abgeholt worden ist. Auf Wunsch und Kosten des Bestellers werden Lieferungen von der Top Light GmbH & Co. KG gegen die üblichen Transportrisiken versichert.
- Wenn der Versand, oder die Zustellung, aus vom Besteller zu vertretenden Gründen verzögert wird oder der Besteller aus sonstigen Gründen in An-nahmeverzug kommt, so geht die Gefahr auf den Besteller über.

VI. Entgegennahme

- Der Besteller darf die Entgegennahme von Lieferungen wegen unerheblicher Mängel nicht verweigern.
- Transportschäden sind direkt bei der Annahme der Ware beim Spediteur zu melden (Warenannahme „unter Vorbehalt“). Eine Haftung der Top Light GmbH & Co. KG tritt nicht ein (Versendungskauf). Die Ware ist komplett auf ihre Menge und Beschaffenheit innerhalb von 5 Werktagen zu überprüfen. Schäden sind unter Angabe der Mängel schriftlich an die Top Light GmbH & Co. KG zu melden. Schäden sind generell vor dem Einbau bzw. der Verarbeitung zu melden. Bei nicht rechtzeitiger Einhaltung dieser Meldepflicht gelten die Schäden als nach der Ablieferung entstanden und werden von der Top Light GmbH & Co. KG nicht anerkannt.
- Retoursendungen – gleich aus welchem Grund – sind mit einer Frist von 14 Tagen anzukündigen und schriftlich zu begründen. Der Besteller erhält eine Retourennummer, mit der die Rücksendung zwingend zu versenden ist, anderenfalls ist die Top Light GmbH & Co. KG berechtigt, die Annahme zu verweigern.

VII. Sachmängel

Für Sachmängel haftet die Top Light GmbH & Co. KG wie folgt:

- Die Beschaffenheit der Produkte ergibt sich ausschließlich und abschließend aus der jeweiligen Produktbeschreibung. Bei Maßen ohne Toleranzanzeige gilt grundsätzlich Genauigkeitsgrad „Mittel“ nach DIN 7168.
- Werden Sachmängel geltend gemacht, sind die beanstandeten Waren zur Prüfung an die Top Light GmbH & Co. KG ordnungsgemäß fachgerecht verpackt und geschützt vor Beschädigungen zurückzusenden. Soweit die Top Light GmbH & Co. KG über eine Rücktransportverpackung verfügt, ist diese anzufordern und für den Rücktransport zu verwenden.
- Die zum Zweck der Prüfung und Nacherfüllung erforderlichen Aufwendungen, insbesondere Transport-, Wege-, Arbeits- und Materialkosten (nicht: Ausbau- und Einbaukosten), trägt die Top Light GmbH & Co. KG, wenn tatsächlich ein Mangel vorliegt. Stellt sich jedoch ein Mangelbeseitigungsverlangen des Bestellers als unberechtigt heraus, kann die Top Light GmbH & Co. KG die hieraus entstandenen Kosten vom Besteller ersetzt verlangen.
- Alle diejenigen Teile oder Leistungen sind nach Wahl der Top Light GmbH & Co. KG unentgeltlich nachzubessern, neu zu liefern oder neu zu erbringen, die einen Sachmangel aufweisen, sofern dessen Ursache bereits zum Zeitpunkt des Gefahrübergangs vorlag.
- Die Haftung für Folgeschäden ist ausgeschlossen.
- Ansprüche auf Nacherfüllung verjähren in 12 Monaten ab gesetzlichem Verjährungsbeginn; Entsprechendes gilt für Rücktritt und Minderung. Diese Frist gilt nicht, soweit das Gesetz gemäß §§ 438 Abs. 1 Nr. 2 (Bauwerke und Sachen für Bauwerke), 479 Abs. 1 (Rückgriffsanspruch) und 634a Abs. 1 Nr. 2 (Baumängel) BGB längere Fristen vorschreibt bei Vorsatz, arglistigem

Verschweigen des Mangels sowie bei Nichteinhaltung einer Beschaffenheitsgarantie. Die gesetzlichen Regelungen über Ablaufhemmung, Hemmung und Neubeginn der Fristen bleiben unberührt.

- Mängelrügen des Bestellers haben unverzüglich schriftlich zu erfolgen.
- Bei Mängelrügen dürfen Zahlungen des Bestellers in einem Umfang zurückbehalten werden, die in einem angemessenen Verhältnis zu den aufgetretenen Sachmängeln stehen. Der Besteller kann Zahlungen nur zurückbehalten, wenn eine Mängelrüge geltend gemacht wird, über deren Berechtigung kein Zweifel bestehen kann. Ein Zurückbehaltungsrecht des Bestellers besteht nicht, wenn seine Mängelansprüche verjährt sind. Erfolgte die Mängelrüge zu Unrecht, ist die Top Light GmbH & Co. KG berechtigt, die ihm entstandenen Aufwendungen vom Besteller ersetzt zu verlangen.
- Mängelansprüche bestehen nicht bei nur unerheblicher Abweichung von der vereinbarten Beschaffenheit, bei nur unerheblicher Beeinträchtigung der Brauchbarkeit, bei natürlicher Abnutzung oder Schäden, die nach dem Gefahrübergang infolge fehlerhafter oder nachlässiger Behandlung, übermäßiger Beanspruchung, ungeeigneter Betriebsmittel, oder die aufgrund besonderer äußerer Einflüsse entstehen, die nach dem Vertrag nicht vorausgesetzt sind. Werden vom Besteller oder von Dritten unsachgemäße Änderungen oder Instandsetzungsarbeiten vorgenommen, so bestehen für diese und die daraus entstehenden Folgen ebenfalls keine Mängelansprüche.
- Schadensersatzansprüche des Bestellers wegen eines Sachmangels sind ausgeschlossen. Dies gilt nicht bei arglistigem Verschweigen des Mangels, bei Nichteinhaltung einer Beschaffenheitsgarantie, bei Verletzung des Lebens, des Körpers, der Gesundheit oder der Freiheit und bei einer vorsätzlichen oder grob fahrlässigen Pflichtverletzung durch die Top Light GmbH & Co. KG. Eine Änderung der Beweislast zum Nachteil des Bestellers ist mit den vorstehenden Regelungen nicht verbunden. Weitergehende oder andere als in diesem Art. VII geregelten Ansprüche des Bestellers wegen eines Sachmangels sind ausgeschlossen.

VIII. Gewerbliche Schutzrechte und Urheberrechte; Rechtsmängel

Ansprüche erhebt, haftet die Top Light GmbH & Co. KG gegenüber dem Besteller innerhalb der in Art. VII Nr. 6 bestimmten Frist wie folgt:

- Die Top Light GmbH & Co. KG wird nach ihrer Wahl auf ihre Kosten für die betretenden Lieferungen entweder ein Nutzungsrecht erwirken, sie so ändern, dass das Schutzrecht nicht verletzt wird, oder austauschen. Ist dies der Top Light GmbH & Co. KG nicht zu angemessenen Bedingungen möglich, stehen dem Besteller die gesetzlichen Rücktritts- oder Minderungsrechte zu.
 - Die Pflicht der Top Light GmbH & Co. KG zur Leistung von Schadensersatz richtet sich nach Art. XI.
 - Die vorstehend genannten Verpflichtungen der Top Light GmbH & Co. KG bestehen nur, soweit der Besteller die Top Light GmbH & Co. KG über die vom Dritten geltend gemachten Ansprüche unverzüglich schriftlich verständigt, eine Verletzung nicht anerkennt und der Top Light GmbH & Co. KG alle Abwehrmaßnahmen und Vergleichsverhandlungen vorbehalten bleiben. Stellt der Besteller die Nutzung der Lieferung aus Schadensminderungs- oder sonstigen wichtigen Gründen ein, ist er verpflichtet, den Dritten darauf hinzuweisen, dass mit der Nutzungseinstellung kein Anerkenntnis einer Schutzrechtsverletzung verbunden ist.
- Ansprüche des Bestellers sind ausgeschlossen, soweit er die Schutzrechtsverletzung zu vertreten hat.
 - Ansprüche des Bestellers sind ferner ausgeschlossen, soweit die Schutzrechtsverletzung durch spezielle Vorgaben des Bestellers, durch eine von der Top Light GmbH & Co. KG nicht voraussehbare Anwendung oder dadurch verursacht wird, dass die Lieferung vom Besteller verändert oder zusammen mit nicht von der Top Light GmbH & Co. KG gelieferten Produkten eingesetzt wird.
 - Im Falle von Schutzrechtsverletzungen gelten für die in Nr. 1 a) geregelten Ansprüche des Bestellers im Übrigen die Bestimmungen des Art. VII Nr. 5, 6 und 10 entsprechend.
 - Bei Vorliegen sonstiger Rechtsmängel gelten die Bestimmungen des Art. VII entsprechend.
 - Weitergehende oder andere als die in diesem Art. VIII geregelten Ansprüche des Bestellers gegen die Top Light GmbH & Co. KG und deren Erfüllungsgehilfen wegen eines Rechtsmangels sind ausgeschlossen.

IX. Unmöglichkeit; Vertragsanpassung

- Soweit die Lieferung unmöglich ist, ist der Besteller berechtigt, Schadensersatz zu verlangen, es sei denn, dass die Top Light GmbH & Co. KG die Unmöglichkeit nicht zu vertreten hat. Jedoch beschränkt sich der Schadensersatzanspruch des Bestellers auf 5% des Wertes desjenigen Teils der Lieferung, der wegen der Unmöglichkeit nicht in zweckdienlichen Betrieb genommen werden kann. Diese Beschränkung gilt nicht, soweit in Fällen des Vorsatzes, der groben Fahrlässigkeit oder wegen der Verletzung des Lebens, des Körpers oder der Gesundheit zwingend gehaftet wird; eine Änderung der Beweislast zum Nachteil des Bestellers ist hiermit nicht verbunden. Das Recht des Bestellers zum Rücktritt vom Vertrag bleibt unberührt.

2. Sofern unvorhersehbare Ereignisse im Sinne von Art. IV Nr. 3 die wirtschaftliche Bedeutung oder den Inhalt der Lieferung erheblich verändern oder auf den Betrieb der Top Light GmbH & Co. KG erheblich einwirken, wird der Vertrag unter Beachtung von Treu und Glauben angemessen angepasst. Soweit dies wirtschaftlich nicht vertretbar ist, steht der Top Light GmbH & Co. KG das Recht zu, vom Vertrag zurückzutreten. Will die Top Light GmbH & Co. KG von diesem Rücktrittsrecht Gebrauch machen, so hat sie dies nach Erkenntnis der Tragweite des Ereignisses unverzüglich dem Besteller mitzuteilen und zwar auch dann, wenn zunächst mit dem Besteller eine Verlängerung der Lieferzeit vereinbart war.

X. Garantie für Top Light Spiegel

Für einen Zeitraum von einem Jahr - gerechnet von dem Tage der Lieferung an - garantieren wir unseren Abnehmern, dass der Belag unserer Spiegel ohne äußere Einwirkung weder fleckig noch blind wird. Bei berechtigten Beanstandungen kann nur Ersatzlieferung verlangt werden. Ein Anspruch verjährt spätestens nach Ablauf von einem Jahr. Im Übrigen gelten die Bestimmungen für Mängelrügen gemäß Ziffer 5 unserer Allgemeinen Verkaufs- und Lieferungsbedingungen entsprechend.

Ein Garantieanspruch besteht nur unter folgenden Voraussetzungen:

- bestimmungsgemäße Verwendung unserer Spiegel in Innenräumen, nicht jedoch bei Verwendung in Reithallen, Schwimmbädern, Heilbädern, Saunen und deren angrenzenden Räumen, mit ständig extrem hoher Luftfeuchtigkeit.
- eine Luftzirkulation zwischen Spiegel und Wandfläche bzw. sonstigen Montageflächen muss durch ausreichenden Wandabstand vorhanden sein. Die Befestigungsteile dürfen nicht aus aggressiven Materialien bestehen. Geputzte und gestrichene Flächen müssen vor der Spiegelmontage ganz ausgetrocknet sein.
- unsere Kontrollzeichen bzw. Schutzmarken auf unseren Spiegeln dürfen nicht entfernt oder unkenntlich werden, um einen einwandfreien Herkunftsnachweis zu ermöglichen.

Ein Garantieanspruch entfällt:

- bei Belagsschäden infolge von Be- und Verarbeitung oder bei fester Verbindung mit Flächen und Stoffen (z.B. Verklebungen, Rahmungen, Entkittungen), sofern dies nicht durch uns geschehen ist.
- bei Belagsschäden infolge der Einwirkung von Wirkstoffen, insbesondere von Flüssigkeiten, die Säuren oder ähnlich wirkende chemische Mittel enthalten, einerlei ob diese direkt oder in Form von Dämpfen mit dem Spiegel in Berührung kommen. Zu diesen Wirkstoffen zählen die meisten handelsüblichen Reinigungsmittel und Kosmetika.
- bei Schäden des Spiegels, die ganz oder teilweise durch mechanische Einwirkung hervorgerufen sind.
- bei Nichteinhaltung unserer Vorschriften für Lagerung und Pflege von Spiegeln, die angefordert werden können.

Der Käufer hat zu beweisen, dass die vorstehend genannten Voraussetzungen erfüllt bzw. Garantieausschlüsse nicht gegeben sind.

XI. Sonstige Schadensersatzansprüche; Verjährung

1. Schadensersatzansprüche des Bestellers, gleich aus welchem Rechtsgrund, insbesondere wegen Verletzung von Pflichten aus dem Schuldverhältnis und aus unerlaubter Handlung, sind ausgeschlossen.
2. Dies gilt nicht, soweit zwingend gehaftet wird, z. B. nach dem Produkthaftungsgesetz, in Fällen des Vorsatzes, der groben Fahrlässigkeit, wegen der Verletzung des Lebens, des Körpers oder der Gesundheit oder wegen der Verletzung wesentlicher Vertragspflichten. Der Schadensersatzanspruch für die Verletzung wesentlicher Vertragspflichten ist jedoch auf den vertragstypischen, vorhersehbaren Schaden begrenzt, soweit nicht Vorsatz oder grobe Fahrlässigkeit vorliegt oder wegen der Verletzung des Lebens, des Körpers oder der Gesundheit gehaftet wird. Eine Änderung der Beweislast zum Nachteil des Bestellers ist mit den vorstehenden Regelungen nicht verbunden.
3. Soweit die Schadensersatzhaftung der Top Light GmbH & Co. KG ausgeschlossen oder eingeschränkt ist, gilt dies auch im Hinblick auf die persönliche Schadensersatzhaftung ihrer Angestellten, Mitarbeiter, Vertreter und Erfüllungsgehilfen.
4. Soweit dem Besteller Schadensersatzansprüche zustehen, verjähren diese mit Ablauf der nach Art. VII Nr. 6 geltenden Verjährungsfrist. Gleiches gilt für Ansprüche des Bestellers im Zusammenhang mit Maßnahmen zur Schadensabwehr (z. B. Rückrufaktionen). Bei Schadensersatzansprüchen nach dem Produkthaftungsgesetz gelten die gesetzlichen Verjährungsvorschriften.

XII. Rücknahmeverpflichtung gem. § 10 Abs. 2 ElektroG

1. Der Besteller übernimmt die Pflicht, die gelieferte Ware nach Nutzungsbeendigung auf eigene Kosten nach den gesetzlichen Vorschriften ordnungsgemäß zu entsorgen und stellt die Top Light GmbH & Co. KG von den Verpflichtungen gem. § 10 Abs. 2 ElektroG (Rücknahmepflicht der Hersteller) und damit im Zusammenhang stehenden Ansprüchen Dritter frei.
2. Sofern der Besteller die Waren an gewerbliche Dritte weitergibt und diese nicht vertraglich zur

Übernahme der Entsorgung und zur Weiterverpflichtung verpflichtet, obliegt es dem Besteller, die gelieferte Ware nach Nutzungsbeendigung auf seine Kosten zurückzunehmen und nach den gesetzlichen Vorschriften ordnungsgemäß zu entsorgen. Der Anspruch der Top Light GmbH & Co. KG auf Übernahme / Freistellung durch den Besteller verjährt nicht vor Ablauf von zwei Jahren nach der endgültigen Beendigung der Nutzung des Gerätes. Die zweijährige Frist der Ablaufhemmung beginnt frühestens mit Zugang einer schriftlichen Mitteilung des Bestellers bei der Top Light GmbH & Co. KG über die Nutzungsbeendigung.

XIII. Gerichtsstand und anwendbares Recht

1. Alleiniger Gerichtsstand (auch für Scheck- und Wechselklagen) ist, wenn es sich bei dem Besteller um einen Kaufmann, eine juristische Person des öffentlichen Rechts oder um ein öffentlich-rechtliches Sondervermögen handelt, bei allen aus dem Vertragsverhältnis unmittelbar oder mittelbar sich ergebenden Streitigkeiten Herford. Die Top Light GmbH & Co. KG ist jedoch auch berechtigt, am Sitz des Bestellers zu klagen.
2. Für die Rechtsbeziehungen im Zusammenhang mit diesem Vertrag gilt deutsches materielles Recht unter Ausschluss des Übereinkommens der Vereinten Nationen über Verträge über den internationalen Warenkauf (CISG).

XIV. Verbindlichkeit des Vertrages

1. Abweichungen von diesen Verkaufs-, Liefer- und Zahlungsbedingungen, einschließlich Änderungen dieser Schriftformklausel, bedürfen zu ihrer Wirksamkeit der Schriftform.
2. Der Vertrag bleibt auch bei rechtlicher Unwirksamkeit einzelner Bestimmungen in seinen übrigen Teilen verbindlich. Das gilt nicht, wenn das Festhalten an dem Vertrag eine unzumutbare Härte für eine Partei darstellen würde.

Terms and conditions of sale, delivery and payment of Top Light GmbH & Co. KG

- Version: January 2020 -

I. General provisions

1. These Terms of Sale, Delivery and Payment constitute the legal framework governing all business relations between Top Light GmbH & Co. KG and its customers (hereafter: Buyer) as regards deliveries of goods and/or services offered by Top Light GmbH & Co. KG (hereafter „deliveries“). This applies to all future business activities and to already existing business relations. General Terms of Business of Buyer shall only apply if Top Light GmbH & Co. KG explicitly acknowledges any such terms in writing. The volume of deliveries is to be stipulated in agreements mutually agreed upon in writing.
2. Top Light GmbH & Co. KG reserves the unlimited right of ownership and intellectual property rights regarding offers, estimates and other documents (hereafter „documents“). Such documents must not be disclosed to third parties without previously obtaining written consent of Top Light GmbH & Co. KG and are to be submitted to Top Light GmbH & Co. KG upon request, if the order is not placed with Top Light GmbH & Co. KG. Clauses 1 and 2 shall also apply to all documents of Buyer; these shall only be disclosed to third parties if Top Light GmbH & Co. KG has commissioned such parties to effect deliveries on its behalf, subject to obtaining previous consent of Buyer.
3. Partial deliveries are acceptable, within reasonable limits.
4. The term „claims for damages“ in the context of these Terms of Sale, Delivery and Payment, comprises claims for reimbursement of unavailing expenses.
5. Offers submitted by Top Light GmbH & Co. KG are non-binding. An agreement shall become binding only after Top Light GmbH & Co. KG issues an order confirmation in writing.
6. All technical details contained in our catalogs, lists, drawings and other sales documentation are made according to the best of our knowledge and diligence. However, they are subject to modification in view of product improvement, and Top Light GmbH & Co. KG reserves the right to modify any such technical details even after an order confirmation has been issued, provided that prices, functionality and delivery periods remain unaffected.

II. Prices and Offsetting

1. Prices are quoted in EUROS ex works, and exclude freight, packaging and the respective VAT.
2. Top Light GmbH & Co. KG shall deliver orders worth more than EUR 500.00 net without charging freight and packaging to addresses within the territory of the Federal Republic of Germany.
3. For orders with differing invoice and delivery addresses Top Light GmbH & Co. KG shall charge a surcharge in the amount of EUR 8.00 net, per differing delivery address, excluding VAT.
4. Invoices shall be issued on the day of delivery at the earliest. If payment is made within 10 days of the invoice date, a discount of 2% shall be granted. The standard payment period is 30 days. If a debit instruction is issued, we shall grant a 3% discount. Within this context, invoices shall be called for the previous month on the 10th of the following month.
5. Initial orders of a new Buyer shall be effected on the basis payment in advance or cash on delivery (COD). Overseas deliveries shall be effected against advance payment of the net invoice amount.
6. In case of custom-made products, half of the invoice amount is to be paid when placing the order. Once confirmed, custom-made orders are irrevocable, i.e. cannot be cancelled by Buyer.
7. In case of a delay in payment Top Light GmbH & Co. KG reserves the right to refuse performance until all amounts due from all unpaid invoices, interests included, have been paid.
8. Buyer is entitled to offset indisputable or legally binding claims only.
9. The orderer shall only be entitled to set off those claims that are undisputed or have been established as final and absolute.
10. Top Light GmbH & Co. KG is entitled but not obliged, to place samples at Buyer's disposal, free of charge for a period of three weeks. Samples must be explicitly indicated as such in every respective order. The charges for samples shall be based on the price lists and delivery terms valid at time of delivery (trial purchase). Buyer is entitled to cancel a trial purchase within the three weeks' period stated above. In case of a cancellation Buyer shall return the goods franco domicile and ensure that the goods be returned in perfect condition. In this case Buyer shall receive a credit note for the amount equaling the purchase price but excluding the cost of freight to delivery address and packaging. Should the goods returned not be in perfect condition, Buyer shall be obliged to pay the full invoice amount.
11. Top Light GmbH & Co. KG is entitled to accommodate Buyer by taking back goods at its own discretion. In this case Top Light GmbH & Co. KG shall charge a processing fee in the amount of 30% of the net invoice amount, excluding VAT.

III. Reservation of Proprietary Rights

1. All goods (conditional goods) shall remain property of Top Light GmbH & Co. KG until all financial obligations of Buyer towards Top Light GmbH & Co. KG have been met. Should the total amount of all liens Top Light GmbH & Co. KG is entitled to, exceed the amount of all secured interests by more than 10%, Top Light GmbH & Co. KG shall release, upon Buyer's

request, a respective share of the liens; Top Light GmbH & Co. KG is entitled to choose freely between various liens.

2. As long as the goods are subject to proprietary rights, Buyer is not entitled to pledging of goods or transferring securities. Buyer shall only be allowed to sell goods subject to proprietary rights to distributors if these agree to sell the goods to their customers against cash payment or as conditional sale until the customers meet all their obligations towards the distributor.
3. Should Buyer sell goods subject to proprietary rights, he herewith agrees to unconditionally transfer all future demands towards his customers, hence revenues from resale, ancillary rights included, to Top Light GmbH & Co. KG. Should Buyer sell the goods subject to proprietary rights collectively with other goods, without establishing an individual price for the goods subject to proprietary rights, he herewith agrees to transfer the share of the total sales amount to Top Light GmbH & Co. KG equaling the invoice amount for the goods subject to proprietary rights.
4. Should the goods subject to proprietary rights of Top Light GmbH & Co. KG lose their original character, by transformation, construction or processing, for example, Buyer herewith agrees to transfer all claims he is entitled to from his customers or third parties, equaling the amount of his obligations according to clause 1, to Top Light GmbH & Co. KG.
5. Buyer is entitled to collect outstanding debts. However, for good reason such as delay in payment, cessation of payment, instigation of an insolvency proceeding, bill protest, evidence of excessive indebtedness, or bankruptcy of Buyer, Top Light GmbH & Co. KG is entitled to revoke this authorization.
6. Top Light GmbH & Co. KG is entitled to disclose assignment of security, to commercialise the assigned book account and to demand disclosure of assignment of security on the part of a customer towards Buyer. Upon request, Buyer is obliged to disclose to Top Light GmbH & Co. KG any assignment of security and names of debtors.
7. In case of seizure, detention or any other form of act of disposal or intervention of third parties, Buyer is obliged to immediately inform Top Light GmbH & Co. KG accordingly. In case of good reason Buyer is obliged to provide Top Light GmbH & Co. KG with details and documents regarding his claims against his customers.
8. Should Buyer violate any of his obligations, delay in payment in particular, Top Light GmbH & Co. KG is entitled to repossess goods or cancel agreements, after expiry of a reasonable period to perform; the statutory provisions on dispensability of granting delays shall remain unaffected. Buyer is obliged to hand over the goods. Repossession of goods or enforcement of proprietary rights or seizure of goods subject to proprietary rights by Top Light GmbH & Co. KG does not represent cancellation of the contract, unless specifically expressed by Top Light GmbH & Co. KG.

IV. Delivery Period and Delay

1. Place of performance for Top Light GmbH & Co. KG is Spenge, Federal Republic of Germany.
2. If the failure to comply with the deadlines is attributable to an instance of force majeure, such as mobilisation, war, insurrection, or to similar events, such as strikes and lock-outs, the deadlines shall be extended accordingly. The same shall apply in cases where deliveries to Top Light GmbH & Co. KG are not made in good time or in the proper manner.
3. In case of failure to perform, due to Force Majeure, i.e. mobilisation, war, unrest or similar phenomena such as industrial action, lockouts, etc., delivery periods shall be extended accordingly. Same applies in case of unpunctual or irregular provision of Top Light GmbH & Co. KG by its suppliers.
4. Should Buyer verifiably suffer losses resulting from delays in delivery on the part of Top Light GmbH & Co. KG, he shall be entitled to claim compensation in the amount of up to 5% of the price of the very item the effective use of which is impossible, as a result of a delay in delivery.
5. Buyer is not entitled to any claims resulting from a delay in delivery or from non-performance beyond the amount stated in clause 3, even after expiry of a last deadline granted to Top Light GmbH & Co. KG in accordance with statutory provisions. This shall not apply in case of an intentional act or gross negligence or damage to a person's life, health and body, or in case of liability resulting from the product liability act or based on any other statutory right. Buyer is not entitled to cancel the contract within the framework of statutory provisions, as long as a delay in delivery remains within reasonable limits. A reversal of evidence to the detriment of Buyer is not affected by the provisions listed above.
6. In case of a delay in delivery, upon request and within a reasonable period, Buyer is obliged to inform Top Light GmbH & Co. KG whether he intends to cancel the order or if he insists on deliveries being effected. After expiry of the period mentioned above Top Light GmbH & Co. KG shall be entitled to cancel the contract concerning the part in question or to cancel the contract.
7. Should more than one month elapse between the date of releasing a delivery note and the date of delivery or reception of goods upon request of Buyer, Top Light GmbH & Co. KG is entitled to charge at Buyer's account storage fees of 0.5% of the invoice amount for every month commenced, but not more than 5% of the invoice amount. Providing evidence of any higher or lower warehouse costs as well as claims for covering other charges, remain at discretion of the contract parties.

V. Transfer of Risk

1. Transport shall be effected at Buyer's risk.
2. Transfer of risk shall take place in the moment of handing the goods over to a forwarder or of the collection of goods, even in case of deliveries free of charge. Upon request and at the expense of Buyer Top Light GmbH & Co. KG shall insure goods against common transport risks.
3. In case of a delay in delivery (sending, receiving or collecting goods) required by Buyer for good reason, or if Buyer is not able to accept the goods for any other reasons, transfer of risk shall take place irrespective of the whereabouts of the goods.

VI. Acceptance

1. Buyer is not entitled to refuse acceptance of (partial-) deliveries for minor defects.
2. Transport damage is to be reported to the forwarder at the time of delivery (qualified acceptance of goods). Top Light GmbH & Co. KG cannot be held liable for transport damages (sale by delivery to a place other than the place of performance). All goods delivered are to be inspected regarding quantity and condition within 5 working days from date of receipt. Details of damages or defaults are to be reported to Top Light GmbH & Co. KG in writing. Damages or defaults are to be reported prior to the goods or parts thereof being processed or incorporated into components. Should Buyer fail to report, according to the provisions stated above, damages and defaults shall not be recognised by Top Light GmbH & Co. KG and shall be considered as transport damages.
3. Return shipments – irrespective of reason – are to be announced within a period of 14 days and all the reasons submitted in writing. Buyer shall obtain a return shipment number and be obliged to register the shipment under the number indicated; otherwise Top Light GmbH & Co. KG is entitled to refuse to accept any such shipment.

VII. Defects

Top Light GmbH & Co. KG shall be liable for defects as follows:

1. Condition of goods is defined by the respective product description exclusively. In the case of dimensions where no tolerance is specified, the "medium" degree of accuracy as defined by DIN 7168 shall apply as a matter of principle.
2. In case of claims for damages resulting from defects, the goods subject to claims are to be returned to Top Light GmbH & Co. KG duly packed and protected from damage during transport. If Top Light GmbH & Co. KG has a backhaul packaging, Buyer shall be obliged to request and use it.
3. Top Light GmbH & Co. KG shall bear the costs related to inspection of goods and supplementary performance, in particular cost of transport, labour and material (not assembly and disassembly costs), if a claim proves to be justified. However, if a Buyer's claim proves to be unjustified, Top Light GmbH & Co. KG is entitled to charge the costs incurred at Buyer's expense.
4. Top Light GmbH & Co. KG shall mend, replace or provide, free of charge, those goods or services which prove to be defective, at it deems best, provided that the cause of defect had existed prior to the transfer of risk.
5. Top Light GmbH & Co. KG cannot be held liable for any subsequent damage.
6. Claims for supplementary performance shall elapse after a period of 12 months, commencing with the first day of the statutory limitation; same applies to cancellations and reductions. This period shall not apply to cases where contrasting regulations in accordance with §§ 438 clause 1 No. 2 (buildings and building equipment), 479 clause 1 (right of recourse) and 634 a) clause 1 No. 2 (construction defects) of the German Civil Code award longer statutory limitation in case of intentional action, deceit and fraudulent concealment of defects and noncompliance with factual nature. Statutory regulations on suspension of statute of limitations, suspension and reinstatement of statutory periods remain unaffected.
7. Buyer's report of defects is to be submitted immediately and in writing.
8. In case of a claim for damages resulting from defects, a retention of payments on the part of Buyer shall be tolerated insofar as they remain within a reasonable proportion of and relation to the defect occurred. Buyer shall be entitled to retain payments only if the defects are acknowledged or established by legal institutions. Buyer is not entitled to resort to the right of retention if the claim for damages becomes statute-barred. If the claim for damages proves to be unjustified, Top Light GmbH & Co. KG is entitled to claim compensation from Buyer for any costs incurred.
9. Claims for damages resulting from defects shall be considered invalid in case of minor deviation from the product nature agreed upon, insignificant limitation of functionality or use, natural tear and wear or damage occurred after the transfer of risk, as a consequence of faulty or negligent treatment, excessive use, improper means of treatment or processing, or special external influence beyond the provisions of this contract. Furthermore, claims for damages resulting from defaults shall not be considered in case of improper modifications or maintenance being carried out by Buyer or third parties, nor for any defaults resulting from any such action.

10. Claims for damages resulting from defects and raised by Buyer based on material defects shall not be considered. This shall not apply in cases of fraudulent concealment of defects, noncompliance regarding nature of product guarantee, damage to a person's life, body and health and in case of gross or intentional violation of duties by Top Light GmbH & Co. KG. A reversal of the burden of proof to the detriment of Buyer shall remain unaffected by the provisions stated above. Any claims differing from those stated in this clause 7 raised by Buyer and based on defects, shall not be considered.

VIII. Industrial and Intellectual Property Rights; Legal Defects

1. Unless otherwise expressly agreed upon, Top Light GmbH & Co. KG shall be obliged to effect deliveries free of industrial and intellectual property rights of third parties (hereafter: property rights) in the country of delivery only. Should a third party raise legitimate claims against Buyer for breach of property rights, based on contract related deliveries effected by Top Light GmbH & Co. KG, Buyer shall be entitled to hold Top Light GmbH & Co. KG liable within the certain periods stipulated in Article VII clause 6, as follows:
 - a) Top Light GmbH & Co. KG shall, at its discretion and at its expense, either acquire right of use for the respective delivery, or modify it, insofar as to avoid infringing property rights, or replace the delivery. Should this not be feasible for Top Light GmbH & Co. KG within reasonable terms and conditions, Buyer shall be entitled to statutory cancellation and additional reductions.
 - b) Obligations of Top Light GmbH & Co. KG as regards compensation of Buyer for damages, are governed by Article XI.
 - c) All obligations of Top Light GmbH & Co. KG stated above shall be effective only if Buyer informs Top Light GmbH & Co. KG immediately and in writing of any claims raised by third parties, if Buyer does not acknowledge claims of infringement and if Top Light GmbH & Co. KG reserves the right to recourse to all means to ward off such claims or to settlement negotiations. Should Buyer interrupt or abandon deliveries for reasons of mitigation of damages or for any other good reason, he shall be obliged to communicate to the third party the fact that abandoning or interrupting deliveries does not imply an acknowledgement of infringement of property rights.
2. All claims of Buyer shall be barred, should he be responsible for infringement of property rights.
3. In addition, claims of Buyer are barred should infringement of property rights result from specific instructions of Buyer, from application of deliveries not envisaged by Top Light GmbH & Co. KG or from Buyer's modifying or using the deliveries in combination with products not delivered by Top Light GmbH & Co. KG.
4. In case of infringement of property rights in accordance with Buyer's claims governed by clause 1 a), provisions of Article VII No. 5, 6, 10 shall apply respectively.
5. Other legal defects are governed by provisions of Article VII respectively.
6. Any further claims of Buyer, or other than those covered by Article VIII, raised against Top Light GmbH & Co. KG and its representatives for any legal defects, are barred.

IX. Impossibility; Contract Adjustment

1. In case of failure of delivery, Buyer shall be entitled to claim compensation for non-performance, unless Top Light GmbH & Co. KG provides evidence that the non-performance is beyond its control. However, the total amount of any such compensation claim is limited to 5% of the value of the item subject to non-performance of delivery. This restriction shall not apply in case of intentional or gross negligence or in case of damage to a person's life, body or health, in case of product liability act or any other case of statutory liability; a reversal of the burden of proof to the detriment of Buyer shall remain unaffected by the provisions stated above. The right of Buyer to cancel the contract remains unaffected.
2. Should the economic importance or the content of a delivery have to be modified, or should it influence the activities of Top Light GmbH & Co. KG substantially as a result of unforeseeable circumstances in accordance with the provisions of Article IV clause No. 3, the contract shall be modified accordingly, acting in good faith. Should such a modification not be economically justifiable, Top Light GmbH & Co. KG shall be entitled to cancel the contract. Should Top Light GmbH & Co. KG intend to make use of this provision, it shall inform Buyer accordingly and immediately upon understanding the amplitude of the situation, even if a delay in deliveries has been agreed upon with Buyer.

X. Warranty for Top-Light Mirrors

We guarantee to our customers that the coating of our mirrors, without extraneous cause, will not become stained or dull for the period of one year, starting from the day of delivery. In case of legitimate complaint, only a replacement can be demanded. Entitlement prescribes after the expiration of one year at the latest. For the rest, our terms of sale and delivery are valid.

A warranty claim only exists under the following conditions:

- Indoor usage according to regulations, but not in indoor riding locations, swimming pools,

- spas, saunas and adjacent rooms with a permanent high humidity.
- Air circulation between mirror and mounting area must be given through adequate wall spacing.
- The mounting parts are not supposed to consist of aggressive materials. Plastered or painted mounting areas have to be hard-dried before mounting the mirror.
- Our test- and trademarks are not supposed to be removed or to be made irrecognisable in order to allow a faultless proof of origin.

A warranty claim does not apply if:

- The coating damage is caused by processing or converting, unless it is carried out by us.
- The coating damage is caused by the effect of contact with agents, especially liquids, that contain acids or other similarly effective substances, no matter if they encounter in direct fashion or in fashion of fumes. This is valid for most of the commercially available detergents and cosmetics.
- The coating damage is caused partly or entirely by mechanical effects.
- In the case of non-compliance to our regulations concerning storage and maintenance of mirrors. Proof can be requested.

The customer is obliged to verify that the preceding conditions are fulfilled or that a cause for warranty exclusion does not exist.

XI. Other Claims for Damages; Limitation Period

1. Claims for damages raised by Buyer, irrespective of their legal basis, especially resulting from violation of contractual obligations or from unauthorised action, are barred.
2. This shall not apply to cases of statutory liability, e.g. Product Liability Act, gross negligence, fraudulent intent, breach of warranty, culpable damage to a person's life, body or health or culpable breach of substantial contractual obligations; whereby claims for damages resulting from culpable breach of substantial contractual obligations remain restricted to liability for typical, foreseeable damages, other than intentional or gross negligence, fraudulent intent, breach of warranty, damages to a person's life, body or health. A reversal of the burden of proof to the detriment of Buyer shall remain unaffected by the provisions stated above.
3. Insofar as liability for damages by Top Light GmbH & Co. KG is excluded or limited, the same shall apply to personal liability for damages of its employees, staff members, representatives and its factors, servants and assignees.
4. Insofar as Buyer is entitled to claims for damages, any such claims shall lapse at the end of the period of limitation according to Article VII clause 6. Same shall apply to claims of Buyer related to any measures of damage prevention (e.g. product recall). In case of claims for damages according to Product Liability Act statutory periods of limitation shall apply.

XII. Take-Back Obligation according to § 10 clause 2 ElektroG (Electrical and Electronic Equipment Act)

1. Buyer agrees to depollute and dispose of deliveries after end of product life at his own expense and according to statutory provisions and to discharge Top Light GmbH & Co. KG from obligations according to § 10 clause 2 ElektroG (Take-Back Obligation of Manufacturer), hence any claims of third parties resulting thereof.
2. Should Buyer pass deliveries on to commercial partners without committing them to take back, depollute and duly dispose of the products delivered, he shall be obliged to take back, depollute and duly dispose of any such goods at the end of product life and in accordance with the respective statutory provisions. Any claim by Top Light GmbH & Co. KG regarding Buyer's take-back obligation shall lapse two years after the irrevocable end of life of an appliance. This two years' period of suspension of statute of limitations shall commence with the date of Buyer informing Top Light GmbH & Co. KG, in writing, of the irrevocable end of life of a product.

XIII. Place of Jurisdiction and Applicable Law

1. Place of Jurisdiction (including actions on cheques and bills of exchange) is Herford, Federal Republic of Germany, concerning all proceedings, whereby Buyer is an established and/or registered merchant, a corporate body under public law, or a special body under public law, and all actions directly or indirectly resulting from or concerning the contract relations of the parties hitherto. Top Light GmbH & Co. KG is also entitled to instigate legal proceedings at place of jurisdiction of Buyer.
2. All legal relations within the framework of this contract are governed by the substantive law of the Federal Republic of Germany to the exclusion of the United Nations Convention on Contracts for the International Sale of Goods (CISG).

XIV. Final Clause

1. Any aberration from these Terms of Sale, Delivery and Payment, including changes to this written form clause, are subject to mutual agreement in writing.

2. Should individual provisions of this contract become legally void, the legal integrity of the contract shall remain unaffected. This clause shall not apply if adherence to the contract imposes unreasonable hardship onto one of the parties hitherto.

Serviceteile – Trafos, Ersatzgläser, Ersatzteile

Serviceparts – Transformers, Replacement glasses, Replacement parts

Modell model	Art. Nr. item no.	Beschreibung design
Dimmer	2-00888	Touch me Dimmer
Touch-Dimmer	PFL-365	Schnurdimmer für Stehleuchten schwarz, cable dimmer for floor lamps black
Dimmer Puk Spot	PFL-369	LED Handdimmer schwarz, LED cable dimmer black
Dimmer Puk Spot	PFL-376	LED Handdimmer transparent, LED cable dimmer transparent
Iglo	9-110	Ersatzglas, Replacement glass
India	9-111	Ersatzglas, Replacement glass
Pisa	Pi-150 Pi-150 m	Ersatzglas Pisa chrom, Replacement glass Pisa chrome Ersatzglas Pisa nickelmatt, Replacement glass Pisa nickel matt
Puk	PFL-131	Verstellhebel für Puk (chr./chr.matt/ni.matt), adjustment lever for Puk lamps
Dimmer	PFL-365	Schiebedimmer für LED Steh-/Tischleuchten auf Anfrage, dimmer for LED floor/table lamps on request
Leuchtstange Flexleuchten	W-111 W-112	Eurozuleitung und Schalter, Stecker, transparent, 2000 mm Euro feed cable and switch, socket, transparent, 2000 mm
Bulb On	TC-114	Ersatzkugel BulbLine opal, Replacement ball BulbLine opal
Bulb Leuchte	BU-100	Ersatzglas, Replacement glass
Dela Short	DE-122NIMATT	Ersatzglas Dela Short nickelmatt, Replacement glass Dela Short nickel matt
Dela Short	DE-122CR	Ersatzglas Dela Short chrom, Replacement glass Dela Short chrome
Dela Quadro Short	DLQ-107NIMATT	Ersatzglas Dela Quadro Short nickelmatt, Replacement glass Dela Quadro Short nickel matt
Dela Quadro Short	DLQ-107CR	Ersatzglas Dela Quadro Short chrom, Replacement glass Dela Quadro Short chrome
Dela	DE-121NIMATT	Ersatzglas Dela nickelmatt, Replacement glass Dela nickel matt
Dela	DE-121CR	Ersatzglas Dela chrom, Replacement glass Dela chrome
Dela Quadro	DLQ-106NIMATT	Ersatzglas Dela Quadro nickelmatt, Replacement glass Dela Quadro nickel matt
Dela Quadro	DLQ-106CR	Ersatzglas Dela Quadro chrom, Replacement glass Dela Quadro chrome

Leuchtmittel

lamps

Art. Nr. Item-No.	Beschreibung Design
8-205	G9 - 3 Watt 300lm 2.700K LED dimmbar, 3-5 watts 300lm 2.700K LED dimmable
8-211	GU10 - 3 Watt 230lm 2.700K LED, 3,5 watts 230lm 2.700K LED
8-309	E27 - 4 Watt 400lm 3.000K LED nicht dimmbar, 4 watts 400lm 3.000K LED not dimmable
8-331	E27 - Filament 7 Watt 806lm 2.700K LED, Filament 7 watts 806lm 2.700K LED
8-491-LED	8 Watt 1-sockelig, 8 watts one base
8-493-LED	16 Watt LED 1.450lm, 16 watts LED 1.450lm
8-524	E14 - 6 Watt 470lm 2.700K LED dimmbar, 6 watts 470lm 2.700K LED dimmable

Produktübersicht Product Overview

Art. Nr. item no.	Seite Page
0-0400	387
0-0500	387
0-0619	387
0-0765100	389
0-07865	389
0101-MT-D	305
0102-MT-D	305
0103-MT-D	306
0117-MT-D	306
0130-MT-D	306
0132-MT-D	306
1-00100	387
1-00101	387
1-00102	387
1-00103	417
1-00104	417
1-00105	387
1-00110	387
1-00113	387
1-00114	387
1-00118	389
1-00190	387
1-00881	389
1-00881	417
1-00882	389
1-00885	389
1-0110060-LED	399
1-016045-LED	399
1-016080-LED	399
1-017050-LED	399
1-017070-LED	399
1-0170-LED	415
1-018040-LED	399
1-018060-LED	399
1-018080-LED	399
1-019050-LED	399
1-019060-LED	399
1-019070-LED	399
1-020000	387
1-0210060-LED	401
1-026045-LED	401
1-026080-LED	401
1-027050-LED	401
1-027070-LED	401
1-0270-LED	415
1-028040-LED	401
1-028060-LED	401
1-028080-LED	401
1-029050-LED	401
1-029060-LED	401
1-029070-LED	401
1-0310060-LED	403
1-036045-LED	403
1-036080-LED	403
1-037050-LED	403
1-037070-LED	403
1-0370-LED	415
1-038040-LED	403
1-038060-LED	403
1-038080-LED	403
1-039050-LED	403
1-039060-LED	403
1-039070-LED	403
1-0460804-O	413
1-0460806-O	413
1-0465806-O- B	413
1-047012 -O	413
1-0470456-O	413
1-04706 -O	413
1-048010011-O	413
1-048012012 -O	413
1-048015012-O	413
1-048015013 -O	413
1-04806010-O	413
1-0480608 -O	413
1-0480708 -O	413
1-04808016- O	413
1-0480808 -O	413
1-0485804-O- B	413
1-0510060-LED	405
1-056045-LED	405
1-056080-LED	405
1-057050-LED	405
1-057070-LED	405
1-0570-LED	415
1-058040-LED	405
1-058060-LED	405
1-058080-LED	405

Art. Nr. item no.	Seite Page
1-059050-LED	405
1-059060-LED	405
1-059070-LED	405
1-0610060-LED	407
1-066045-LED	407
1-066080-LED	407
1-067050-LED	407
1-067070-LED	407
1-0670-LED	415
1-068040-LED	407
1-068060-LED	407
1-068080-LED	407
1-069050-LED	407
1-069060-LED	407
1-069070-LED	407
1-0710060-LED	409
1-076045-LED	409
1-076080-LED	409
1-077050-LED	409
1-077070-LED	409
1-078040-LED	409
1-078060-LED	409
1-078080-LED	409
1-079050-LED	409
1-079060-LED	409
1-079070-LED	409
1-0813100	389
1-0813120	389
1-081330	389
1-081340	389
1-081350	389
1-081360	389
1-081380	389
1-081390	389
1-08777	389
1-08789	389
1-08999	389
11-01120120	459
11-01120120+	459
11-01140140	459
11-01140140+	459
11-01160160	459
11-01160160+	459
11-015060	459
11-015060+	459
11-016070	459
11-016070+	459
11-017085	459
11-017085+	459
12-01100100	457
12-01100100+	457
12-01100200	457
12-01100200+	457
12-016060	457
12-016060+	457
12-018080	457
12-018080+	457
13-01010	463
13-01025	463
13-01050	463
13-01100	463
13-01102	463
13-01104	463
13-01105	463
15-4000-30	447
15-4000-31	447
15-4000-32	447
15-4000-33	447
15-4001-30	449
15-4001-31	449
15-4001-32	449
15-4001-33	449
15-4020	447
15-4020	449
16-01100100	461
16-01100100+	461
16-015060	461
16-015060+	461
16-016070	461
16-016070+	461
16-017090	461
16-017090+	461
16-02-MT-D	307
16-05-MT-D	307
16-06303-MT-D	307
16-06306-MT-D	307
16-0630X-MT-D	307
19-0111	453

Art. Nr. item no.	Seite Page
19-01130	453
19-01180	453
19-01-B	453
19-01-GE	453
19-01-GR	453
19-01-R	453
19-01-W	453
19-02130	451
19-02-B	451
19-02-GE	451
19-02-GR	451
19-02-R	451
19-02-W	451
19-031	451
19-031	453
19-033	451
19-033	453
19-10	451
19-10	453
1-IP44	389
2-00888	473
20114-LED-MT-D	302
2-0301	167
2-0301-LED	167
2-0302	167
2-0302-23	167
2-0302-BE	167
2-0302-LED	167
2-0302-LED-23	167
2-0302-LED-BE	167
2-0302-LED-WE	167
2-0302-WE	167
2-0303	167
2-0303-LED	167
2-0304	167
2-0304-LED	167
2-0309	167
2-0309-LED	167
2-0311	369
2-0311-LED	369
2-0312	369
2-0312-02	369
2-0312-22	369
2-0312-23	369
2-0312-LED	369
2-0312-LED-02	369
2-0312-LED-22	369
2-0312-LED-23	369
2-0313	369
2-0313-LED	369
2-0314	369
2-0314-LED	369
2-0319	369
2-0319-LED	369
2-0402	169
2-0402-02	169
2-0402-22	169
2-0402-23	169
2-0402-LED	169
2-0402-LED-02	169
2-0402-LED-22	169
2-0402-LED-23	169
2-0409	169
2-0409-LED	169
2-0412	371
2-0412-02	371
2-0412-22	371
2-0412-23	371
2-0412-LED	371
2-0412-LED-02	371
2-0412-LED-22	371
2-0412-LED-23	371
2-0419	371
2-0419-LED	371
2-0422	169
2-0422-02	169
2-0422-22	169
2-0422-23	169
2-0422-LED	169
2-0422-LED-02	169
2-0422-LED-22	169
2-0422-LED-23	169
2-0429	169
2-0429-LED	169
2-0432	371
2-0432-02	371
2-0432-22	371
2-0432-23	371

Art. Nr. item no.	Seite Page
2-0432-LED	371
2-0432-LED-02	371
2-0432-LED-22	371
2-0432-LED-23	371
2-0439	371
2-0439-LED	371
2-0501	387
2-058201	125
2-058201-LED	125
2-058202	125
2-058202-02	125
2-058202-22	125
2-058202-23	125
2-058202-LED	125
2-058202-LED-02	125
2-058202-LED-22	125
2-058202-LED-23	125
2-058203	125
2-058203-LED	125
2-058301	125
2-058301-LED	125
2-058302	125
2-058302-02	125
2-058302-22	125
2-058302-23	125
2-058302-LED	125
2-058302-LED-02	125
2-058302-LED-22	125
2-058302-LED-23	125
2-058303	125
2-058303-LED	125
2-08001	17
2-08001-LED	17
2-08002	17
2-08002-02	17
2-080021	19
2-080021-LED	19
2-080022	19
2-080022-02	19
2-08002-22	17
2-080022-22	19
2-080022-23	19
2-080023	17
2-080023-LED	19
2-080022-LED-02	19
2-080022-LED-22	19
2-080022-LED-23	19
2-080023	19
2-080023-LED	19
2-080026	19
2-08002-LED	17
2-08002-LED-02	17
2-08002-LED-22	17
2-08002-LED-23	17
2-08003	17
2-08003-LED	17
2-08006	17
2-0801	119
2-08011	355
2-08011-LED	355
2-08012	355
2-08012-02	355
2-08012-22	355
2-08012-23	355
2-08012-LED	355
2-08012-LED-02	355
2-08012-LED-22	355
2-08012-LED-23	355
2-08013	355
2-08013-LED	355
2-08016	355
2-08016-LED	355
2-0801-LED	119
2-0802	119
2-0802-02	119
2-0802-22	119
2-0802-23	119
2-0802-LED	119
2-0802-LED-02	119
2-0802-LED-22	119
2-0802-LED-23	119
2-0803	119
2-08031	355
2-08031-LED	355
2-08032	355
2-08032-02	355
2-08032-22	355
2-08032-23	355

Art. Nr. item no.	Seite Page
2-08032-LED	355
2-08032-LED-02	355
2-08032-LED-22	355
2-08032-LED-23	355
2-08033	355
2-08033-LED	355
2-08036	355
2-08036-LED	355
2-0803-LED	119
2-0806	119
2-08062	43
2-08062	129
2-08062-02	43
2-08062-02	129
2-08062-22	43
2-08062-22	129
2-08062-23	43
2-08062-23	129
2-08062-LED	43
2-08062-LED	129
2-08062-LED-02	43
2-08062-LED-02	129
2-08062-LED-22	43
2-08062-LED-22	129
2-08062-LED-23	43
2-08062-LED-23	129
2-0806-LED	119
2-081001	51
2-081001-LED	51
2-081002	51
2-081002-02	51
2-081002-22	51
2-081002-23	51
2-081002-LED	51
2-081002-LED-22	51
2-081002-LED-23	51
2-081003	51
2-081003-LED	51
2-08101	47
2-08101-LED	47
2-08102	47
2-08102-02	47
2-08102-22	47
2-08102-23	47
2-08102-LED	47
2-08102-LED-02	47
2-08102-LED-22	47
2-08102-LED-23	47
2-08103	47
2-08103-LED	47
2-0811	115
2-08111	47
2-08111-LED	47
2-08112	47
2-08112-02	47
2-08112-22	47
2-08112-23	47
2-08112-LED	47
2-08112-LED-02	47
2-08112-LED-22	47
2-08112-LED-23	47
2-08113	47
2-08113-LED	47
2-0811-4LED	115
2-0811-LED	115
2-0812	115
2-081201	51
2-081201-LED	51
2-081202	51
2-081202-02	51
2-081202-22	51
2-081202-23	51
2-081202-LED	51
2-081202-LED-02	51
2-081202-LED-22	51
2-081202-LED-23	51
2-081203	51
2-081203-LED	51
2-0812-23	115
2-0812-4LED	115
2-0812-4LED-23	115
2-0812-4LED-BE	115
2-0812-4LED-WE	115
2-0812-BE	115
2-0812-LED	115
2-0812-LED-23	115
2-0812-LED-BE	115

Art. Nr. item no.	Seite Page
2-0812-LED-WE	115
2-0812-WE	115
2-0813	115
2-0813-4LED	115
2-0813-LED	115
2-0816	115
2-0816-4LED	115
2-0816-LED	115
2-08201	51
2-08201	137
2-08201-LED	51
2-08201-LED	137
2-08202	51
2-08202	137
2-08202-02	51
2-08202-02	137
2-08202-22	51
2-08202-22	137
2-08202-23	51
2-08202-23	137
2-08202-LED	51
2-08202-LED	137
2-08202-LED-02	51
2-08202-LED-02	137
2-08202-LED-22	51
2-08202-LED-22	137
2-08202-LED-23	51
2-08202-LED-23	137
2-082-02-LED-MT-B	299
2-08203	51
2-08203	137
2-08203-LED	51
2-08203-LED	137
2-0821	43
2-0821	129
2-08211	359
2-08211-LED	359
2-08212	359
2-08212-02	359
2-08212-22	359
2-08212-23	359
2-08212-LED	359
2-08212-LED-02	359
2-08212-LED-22	359
2-08212-LED-23	359
2-08213	359
2-08213-LED	359
2-08216	359
2-08216-LED	43
2-0821-LED	129
2-0821-LED-MT-C 263	299
2-0822	43
2-0822	129
2-0822-02	43
2-0822-02	129
2-0822-22	43
2-0822-22	129
2-0822-23	43
2-0822-23	129
2-082-22-LED-MT-A	299
2-0822-LED	43
2-0822-LED	129
2-0822-LED-02	43
2-0822-LED-02	129
2-0822-LED-22	43
2-0822-LED-22	129
2-0822-LED-23	43
2-0822-LED-23	129
2-0822-LED-MT-D 263	299
2-0823	43
2-0823	129
2-0823-LED	43
2-0823-LED	129
2-08301	51
2-08301	137
2-08301-LED	51
2-08301-LED	137
2-08302	51
2-08302	137
2-08302-02	51
2-08302-02	137
2-08302-22	51
2-08302-22	137
2-08302-23	51
2-08302-23	137
2-08302-LED	51
2-08302-LED	137

Produktübersicht Product Overview

Art. Nr. item no.	Seite Page
2-08302-LED-02	51
2-08302-LED-02	137
2-08302-LED-22	51
2-08302-LED-22	137
2-08302-LED-23	51
2-08302-LED-23	137
2-08303	51
2-08303	137
2-08303-LED	51
2-08303-LED	137
2-0831	43
2-0831	129
2-0831-LED	43
2-0831-LED	129
2-0832	43
2-0832	129
2-0832-02	43
2-0832-02	129
2-0832-22	43
2-0832-22	129
2-0832-23	43
2-0832-23	129
2-0832-LED	43
2-0832-LED	129
2-0832-LED-02	43
2-0832-LED-02	129
2-0832-LED-22	43
2-0832-LED-22	129
2-0832-LED-23	43
2-0832-LED-23	129
2-0833	43
2-0833	129
2-0833-LED	43
2-0833-LED	129
2-08401	51
2-08401	137
2-08401-LED	51
2-08401-LED	137
2-08402	51
2-08402	137
2-08402-02	51
2-08402-02	137
2-08402-22	51
2-08402-22	137
2-08402-23	51
2-08402-23	137
2-08402-LED	51
2-08402-LED	137
2-08402-LED-02	51
2-08402-LED-02	137
2-08402-LED-22	51
2-08402-LED-22	137
2-08402-LED-23	137
2-08402-LED-23	137
2-08402-LED-MT-B	301
2-08403	51
2-08403	137
2-08403-LED	51
2-08403-LED	137
2-0841	47
2-0841	133
2-08411	359
2-08411-LED	359
2-08412	359
2-08412-02	359
2-08412-22	359
2-08412-23	359
2-08412-LED	359
2-08412-LED-02	359
2-08412-LED-22	359
2-08412-LED-23	359
2-08413	359
2-08413-LED	359
2-08416	359
2-08416-LED	359
2-0841-LED	47
2-0841-LED	133
2-0841-LED-MT-C	301
2-0842	47
2-0842	133
2-0842-02	47
2-0842-02	133
2-0842-22	47
2-0842-22	133
2-0842-23	47
2-0842-23	133
2-0842-23-LED-MT-A	301
2-0842-LED	47

Art. Nr. item no.	Seite Page
2-0842-LED	133
2-0842-LED-02	47
2-0842-LED-02	133
2-0842-LED-22	47
2-0842-LED-22	133
2-0842-LED-23	47
2-0842-LED-23	133
2-0842-LED-MT-D	301
2-0843	47
2-0843	133
2-0843-LED	47
2-0843-LED	133
2-0851	47
2-0851	133
2-0851-LED	47
2-0851-LED	133
2-0852	47
2-0852	133
2-0852-02	47
2-0852-02	133
2-0852-22	47
2-0852-22	133
2-0852-23	47
2-0852-23	133
2-0852-LED	47
2-0852-LED	133
2-0852-LED-02	47
2-0852-LED-02	133
2-0852-LED-22	47
2-0852-LED-22	133
2-0852-LED-23	47
2-0852-LED-23	133
2-0853	47
2-0853	133
2-0853-LED	47
2-0853-LED	133
2-08601	51
2-08601-LED	51
2-08602	51
2-08602-02	51
2-08602-22	51
2-08602-23	51
2-08602-LED	51
2-08602-LED-02	51
2-08602-LED-22	51
2-08602-LED-23	51
2-08603	51
2-08603-LED	51
2-0861	43
2-0861	129
2-0861-LED	43
2-0861-LED	129
2-0863	43
2-0863	129
2-0863-LED	43
2-0863-LED	129
2-0871	43
2-0871-LED	43
2-0872	43
2-0872-02	43
2-0872-22	43
2-0872-23	43
2-0872-LED	43
2-0872-LED-02	43
2-0872-LED-22	43
2-0872-LED-23	43
2-0873	43
2-0873-LED	43
2-08801	51
2-08801-LED	51
2-08802	51
2-08802-02	51
2-08802-22	51
2-08802-23	51
2-08802-LED	51
2-08802-LED-02	51
2-08802-LED-22	51
2-08802-LED-23	51
2-08803	51
2-08803-LED	51
2-0881	43
2-0881-LED	43
2-0882	43
2-0882-02	43
2-0882-22	43
2-0882-23	43
2-0882-LED	43
2-0882-LED-02	43

Art. Nr. item no.	Seite Page
2-0882-LED-22	43
2-0882-LED-23	43
2-0883	43
2-0883-LED	43
2-0891	47
2-0891-LED	47
2-0892	47
2-0892-02	47
2-0892-22	47
2-0892-23	47
2-0892-LED	47
2-0892-LED-02	47
2-0892-LED-22	47
2-0892-LED-23	47
2-0893	47
2-0893-LED	47
2-091001	55
2-091001-LED	55
2-091002	55
2-091002-02	55
2-091002-22	55
2-091002-23	55
2-091002-LED	55
2-091002-LED-02	55
2-091002-LED-22	55
2-091002-LED-23	55
2-091003	55
2-091003-LED	55
2-091201	55
2-091201-LED	55
2-091202	55
2-091202-02	55
2-091202-22	55
2-091202-23	55
2-091202-LED	55
2-091202-LED-02	55
2-091202-LED-22	55
2-091202-LED-23	55
2-091203	55
2-091203-LED	55
2-09201	55
2-09201	141
2-09201-LED	55
2-09201-LED	141
2-09202	55
2-09202	141
2-09202-02	55
2-09202-02	141
2-09202-22	55
2-09202-22	141
2-09202-23	55
2-09202-23	141
2-09202-LED	55
2-09202-LED	141
2-09202-LED-02	55
2-09202-LED-02	141
2-09202-LED-22	55
2-09202-LED-22	141
2-09202-LED-23	55
2-09202-LED-23	141
2-09203	55
2-09203	141
2-09203-LED	55
2-09203-LED	141
2-09301	55
2-09301	141
2-09301-LED	55
2-09301-LED	141
2-09302	55
2-09302	141
2-09302-02	55
2-09302-02	141
2-09302-22	55
2-09302-22	141
2-09302-23	55
2-09302-23	141
2-09302-LED	55
2-09302-LED	141
2-09302-LED-02	55
2-09302-LED-02	141
2-09302-LED-22	55
2-09302-LED-22	141
2-09302-LED-23	55
2-09302-LED-23	141
2-09303	55
2-09303	141
2-09303-LED	55
2-09303-LED	141

Art. Nr. item no.	Seite Page
2-09401	55
2-09401	141
2-09401-LED	55
2-09401-LED	141
2-09402	55
2-09402	141
2-09402-02	55
2-09402-02	141
2-09402-22	55
2-09402-22	141
2-09402-23	55
2-09402-23	141
2-09402-LED	55
2-09402-LED	141
2-09402-LED-02	55
2-09402-LED-02	141
2-09402-LED-22	55
2-09402-LED-22	141
2-09402-LED-23	55
2-09402-LED-23	141
2-09403	55
2-09403	141
2-09403-LED	55
2-09403-LED	141
2-09601	55
2-09601-LED	55
2-09602	55
2-09602-02	55
2-09602-22	55
2-09602-23	55
2-09602-LED	55
2-09602-LED-02	55
2-09602-LED-22	55
2-09602-LED-23	55
2-09603	55
2-09603-LED	55
2-09801	55
2-09801-LED	55
2-09802	55
2-09802-02	55
2-09802-22	55
2-09802-23	55
2-09802-LED	55
2-09802-LED-02	55
2-09802-LED-22	55
2-09802-LED-23	55
2-09803	55
2-09803-LED	55
2-101001	155
2-101001-LED	155
2-101002	155
2-101002-02	155
2-101002-22	155
2-101002-23	155
2-101002-LED	155
2-101002-LED-02	155
2-101002-LED-22	155
2-101002-LED-23	155
2-101501	157
2-101501-LED	157
2-101502	157
2-101502-02	157
2-101502-22	157
2-101502-23	157
2-101502-LED	157
2-101502-LED-02	157
2-101502-LED-22	157
2-101502-LED-23	157
2-101503	157
2-101503-LED	157
2-101504	157
2-101504-02	157
2-101504-22	157
2-101504-23	157
2-101504-LED	157
2-101504-LED-02	157
2-101504-LED-22	157
2-101504-LED-23	157
2-101505	157
2-101506	157
2-101506-02	157
2-101506-22	157
2-101506-23	157
2-1201	159
2-18001	23
2-18001-LED	23
2-18002	23
2-18002-02	23

Art. Nr. item no.	Seite Page
2-18002-22	23
2-18002-23	23
2-18002-LED	23
2-18002-LED-02	23
2-18002-LED-22	23
2-18002-LED-23	23
2-18003	23
2-18003-LED	23
2-18006	23
2-18006-LED	23
2-200101	375
2-200102	375
2-200103	375
2-200117	375
2-200130	375
2-200130-IP44	375
2-200132	375
2-200201	375
2-200202	375
2-200203	375
2-200217	375
2-200230	375
2-200230-IP44	375
2-200232	375
2-28001	29
2-28001-LED	29
2-28002	29
2-28002-02	29
2-28002-22	29
2-28002-23	29
2-28002-LED	29
2-28002-LED-02	29
2-28002-LED-22	29
2-28002-LED-23	29
2-28003	29
2-28003-LED	29
2-28006	29
2-28006-LED	29
2-3008001	21
2-3008001-H	21
2-3008002	21
2-3008002-02	21
2-3008002-22	21
2-3008002-23	21
2-3008002-H	21
2-3008002-H-02	21
2-3008002-H-22	21
2-3008002-H-23	21
2-3008003	21
2-3008003-H	21
2-3008006	21
2-3008006-H	21
2-3018001	25
2-3018001-H	25
2-3018002	25
2-3018002-02	25
2-3018002-22	25
2-3018002-23	25
2-3018002-H	25
2-3018002-H-02	25
2-3018002-H-22	25
2-3018002-H-23	25
2-3018003	25
2-3018003-H	25
2-3018006	25
2-3018006-H	25
2-3028001	31
2-3028001-H	31
2-3028002	31
2-3028002-02	31
2-3028002-22	31
2-3028002-23	31
2-3028002-H	31
2-3028002-H-02	31
2-3028002-H-22	31
2-3028002-H-23	31
2-3028003	31
2-3028003-H	31
2-3028006	31
2-3028006-H	31
2-3038001	31
2-3038001-H	31
2-3038002	31
2-3038002-02	31
2-3038002-22	31
2-3038002-23	31
2-3038002-H	31
2-3038002-H-02	31
2-3038002-H-22	31
2-3038002-H-23	31
2-3038003	31
2-3038003-H	31
2-3038006	31
2-3038006-H	31
2-3038001	31
2-3038001-H	31
2-3038002	31
2-3038002-02	31
2-3038002-22	31
2-3038002-23	31
2-3038002-H	31
2-3038002-H-02	31
2-3038002-H-22	31
2-3038002-H-23	31

Art. Nr. item no.	Seite Page
2-3038002-H-22	31
2-3038002-H-23	31
2-3038003	31
2-3038003-H	31
2-3038006	31
2-3038006-H	31
2-3058201	127
2-3058201-LED	127
2-3058202	127
2-3058202-02	127
2-3058202-22	127
2-3058202-23	127
2-3058202-LED	127
2-3058202-LED-02	127
2-3058202-LED-22	127
2-3058202-LED-23	127
2-3058203	127
2-3058203-LED	127
2-3058301	127
2-3058301-LED	127
2-3058302	127
2-3058302-02	127
2-3058302-22	127
2-3058302-23	127
2-3058302-LED	127
2-3058302-LED-02	127
2-3058302-LED-22	127
2-3058302-LED-23	127
2-3058303	127
2-3058303-LED	127
2-30721	59
2-30721	145
2-30721-H	59
2-30721-H	145
2-30722	59
2-30722	145
2-30722-02	59
2-30722-02	145
2-30722-22	59
2-30722-22	145
2-30722-23	59
2-30722-23	145
2-30722-H	59
2-30722-H	145
2-30722-H-02	59
2-30722-H-02	145
2-30722-H-22	59
2-30722-H-22	145
2-30722-H-23	59
2-30722-H-23	145
2-30723	59
2-30723	145
2-30723-H	59
2-30723-H	145
2-30731	59
2-30731	145
2-30731-H	59
2-30731-H	145
2-30732	59
2-30732	145
2-30732-02	59
2-30732-02	145
2-30732-22	59
2-30732-22	145
2-30732-23	59
2-30732-23	145
2-30732-H	59
2-30732-H	145
2-30732-H-02	59
2-30732-H-02	145
2-30732-H-22	59
2-30732-H-22	145
2-30732-H-23	59
2-30732-H-23	145
2-30733	59
2-30733	145
2-30733-H	59
2-30733-H	145
2-30801	121
2-308011	357
2-308012	357
2-308012-02	357
2-308012-22	357
2-308012-23	357
2-308013	357
2-308016	357
2-30801-H	121
2-30802	121

Produktübersicht Product Overview

Art. Nr. item no.	Seite Page
2-30802-02	121
2-30802-22	121
2-30802-23	121
2-30802-H	121
2-30802-H-02	121
2-30802-H-22	121
2-30802-H-23	121
2-30803	121
2-308031	357
2-308031-H	357
2-308032	357
2-308032-02	357
2-308032-22	357
2-308032-23	357
2-308032-H	357
2-308032-H-02	357
2-308032-H-22	357
2-308032-H-23	357
2-308033	357
2-308033-H	357
2-308036	357
2-308036-H	357
2-30803-H	121
2-30806	121
2-30806-H	121
2-308101	49
2-308101-H	49
2-308102	49
2-308102-02	49
2-308102-22	49
2-308102-23	49
2-308102-H	49
2-308102-H-02	49
2-308102-H-22	49
2-308102-H-23	49
2-308103	49
2-308103-H	49
2-30811	117
2-308111	49
2-308111-H	49
2-308112	49
2-308112-02	49
2-308112-22	49
2-308112-23	49
2-308112-H	49
2-308112-H-02	49
2-308112-H-22	49
2-308112-H-23	49
2-308113	49
2-308113-H	49
2-30812	117
2-30812-02	117
2-30812-22	117
2-30812-23	117
2-30813	117
2-30816	117
2-30821	45
2-30821	131
2-308211	361
2-308212	361
2-308212-02	361
2-308212-22	361
2-308212-23	361
2-308213	361
2-308216	361
2-30821-H	45
2-30821-H	131
2-30822	45
2-30822	131
2-30822-02	45
2-30822-02	131
2-30822-22	45
2-30822-22	131
2-30822-23	45
2-30822-23	131
2-30822-H	45
2-30822-H	131
2-30822-H-02	45
2-30822-H-02	131
2-30822-H-22	45
2-30822-H-22	131
2-30822-H-23	45
2-30822-H-23	131
2-30823	45
2-30823	131
2-30823-H	45
2-30823-H	131
2-30831	45

Art. Nr. item no.	Seite Page
2-30831	131
2-30831-H	45
2-30831-H	131
2-30832	45
2-30832	131
2-30832-02	45
2-30832-02	131
2-30832-22	45
2-30832-22	131
2-30832-23	45
2-30832-23	131
2-30832-H	45
2-30832-H	131
2-30832-H-02	45
2-30832-H-02	131
2-30832-H-22	45
2-30832-H-22	131
2-30832-H-23	45
2-30832-H-23	131
2-30833	45
2-30833	131
2-30833-H	45
2-30833-H	131
2-30841	49
2-30841	135
2-308411	361
2-308411-H	361
2-308412	361
2-308412-02	361
2-308412-22	361
2-308412-23	361
2-308412-H	361
2-308412-H-02	361
2-308412-H-22	361
2-308412-H-23	361
2-308413	361
2-308413-H	361
2-308416	361
2-308416-H	361
2-30841-H	49
2-30841-H	135
2-30842	49
2-30842	135
2-30842-02	49
2-30842-02	135
2-30842-22	49
2-30842-22	135
2-30842-23	49
2-30842-23	135
2-30842-H	49
2-30842-H	135
2-30842-H-02	49
2-30842-H-02	135
2-30842-H-22	49
2-30842-H-22	135
2-30842-H-23	49
2-30842-H-23	135
2-30843	49
2-30843	135
2-30843-H	49
2-30843-H	135
2-30851	49
2-30851	135
2-30851-H	49
2-30851-H	135
2-30852	49
2-30852	135
2-30852-02	49
2-30852-02	135
2-30852-22	49
2-30852-22	135
2-30852-23	49
2-30852-23	135
2-30852-H	49
2-30852-H	135
2-30852-H-02	49
2-30852-H-02	135
2-30852-H-22	49
2-30852-H-22	135
2-30852-H-23	49
2-30852-H-23	135
2-30853	49
2-30853	135
2-30853-H	49
2-30853-H	135
2-30861	45
2-30861	131
2-30861-H	45

Art. Nr. item no.	Seite Page
2-30861-H	131
2-30862	45
2-30862	131
2-30862-02	45
2-30862-02	131
2-30862-22	45
2-30862-22	131
2-30862-23	45
2-30862-23	131
2-30862-H	45
2-30862-H	131
2-30862-H-02	45
2-30862-H-02	131
2-30862-H-22	45
2-30862-H-22	131
2-30862-H-23	45
2-30862-H-23	131
2-30863	45
2-30863	131
2-30863-H	45
2-30863-H	131
2-30871	45
2-30871-H	45
2-30872	45
2-30872-02	45
2-30872-22	45
2-30872-23	45
2-30872-H	45
2-30872-H-02	45
2-30872-H-22	45
2-30872-H-23	45
2-30873	45
2-30873-H	45
2-30881	45
2-30881-H	45
2-30882	45
2-30882-02	45
2-30882-22	45
2-30882-23	45
2-30882-H	45
2-30882-H-02	45
2-30882-H-22	45
2-30882-H-23	45
2-30883	45
2-30883-H	45
2-30891	49
2-30891-H	49
2-30892	49
2-30892-02	49
2-30892-22	49
2-30892-23	49
2-30892-H	49
2-30892-H-02	49
2-30892-H-22	49
2-30892-H-23	49
2-30893	49
2-30893-H	49
2-320103	183
2-320117	183
2-320132	183
2-320203	183
2-320217	183
2-320232	183
2-3800-02-LED-MT-B	299
2-38001	29
2-38001-LED	29
2-38001-LED-MT-C	299
2-38002	29
2-38002-02	29
2-38002-22	29
2-38002-23	29
2-3800-22-LED-MT-A	299
2-38002-LED	29
2-38002-LED-02	29
2-38002-LED-22	29
2-38002-LED-23	29
2-38002-LED-MT-D	299
2-38003	29
2-38003-LED	29
2-38006	29
2-38006-LED	29
2-381001	53
2-381001-H	53
2-381002	53
2-381002-02	53
2-381002-22	53
2-381002-23	53
2-381002-H	53

Art. Nr. item no.	Seite Page
2-381002-H-02	53
2-381002-H-22	53
2-381002-H-23	53
2-381003	53
2-381003-H	53
2-381201	53
2-381201-H	53
2-381202	53
2-381202-02	53
2-381202-22	53
2-381202-23	53
2-381202-H	53
2-381202-H-02	53
2-381202-H-22	53
2-381202-H-23	53
2-381203	53
2-381203-H	53
2-38201	53
2-38201	139
2-38201-H	53
2-38201-H	139
2-38202	53
2-38202	139
2-38202-02	53
2-38202-02	139
2-38202-22	53
2-38202-22	139
2-38202-23	53
2-38202-23	139
2-38202-H	53
2-38202-H	139
2-38202-H-02	53
2-38202-H-02	139
2-38202-H-22	53
2-38202-H-22	139
2-38202-H-23	53
2-38202-H-23	139
2-38203	53
2-38203	139
2-38203-H	53
2-38203-H	139
2-38301	53
2-38301	139
2-38301-H	53
2-38301-H	139
2-38302	53
2-38302	139
2-38302-02	53
2-38302-02	139
2-38302-22	53
2-38302-22	139
2-38302-23	53
2-38302-23	139
2-38302-H	53
2-38302-H	139
2-38302-H-02	53
2-38302-H-02	139
2-38302-H-22	53
2-38302-H-22	139
2-38302-H-23	53
2-38302-H-23	139
2-38303	53
2-38303	139
2-38303-H	53
2-38303-H	139
2-38401	53
2-38401-H	53
2-38402	53
2-38402-02	53
2-38402-22	53
2-38402-23	53
2-38402-H	53
2-38402-H-02	53
2-38402-H-22	53
2-38402-H-23	53
2-38403	53
2-38403-H	53
2-38601	53
2-38601-H	53
2-38602	53
2-38602-02	53
2-38602-22	53
2-38602-23	53
2-38602-H	53
2-38602-H-02	53
2-38602-H-22	53
2-38602-H-23	53
2-38603	53

Art. Nr. item no.	Seite Page
2-38603-H	53
2-38801	53
2-38801-H	53
2-38802	53
2-38802-02	53
2-38802-22	53
2-38802-23	53
2-38802-H	53
2-38802-H-02	53
2-38802-H-22	53
2-38802-H-23	53
2-38803	53
2-38803-H	53
2-391001	57
2-391001-H	57
2-391002	57
2-391002-02	57
2-391002-22	57
2-391002-23	57
2-391002-H	57
2-391002-H-02	57
2-391002-H-22	57
2-391002-H-23	57
2-391003	57
2-391003-H	57
2-391201	57
2-391201-H	57
2-391202	57
2-391202-02	57
2-391202-22	57
2-391202-23	57
2-391202-H	57
2-391202-H-02	57
2-391202-H-22	57
2-391202-H-23	57
2-391203	57
2-391203-H	57
2-39201	57
2-39201	143
2-39201-H	57
2-39201-H	143
2-39202	57
2-39202	143
2-39202-02	57
2-39202-02	143
2-39202-22	57
2-39202-22	143
2-39202-23	57
2-39202-23	143
2-39202-H	57
2-39202-H	143
2-39202-H-02	57
2-39202-H-02	143
2-39202-H-22	57
2-39202-H-22	143
2-39202-H-23	57
2-39202-H-23	143
2-39203	57
2-39203	143
2-39203-H	57
2-39203-H	143
2-39301	57
2-39301	143
2-39301-H	57
2-39301-H	143
2-39302	57
2-39302	143
2-39302-02	57
2-39302-02	143
2-39302-22	57
2-39302-22	143
2-39302-23	57
2-39302-23	143
2-39302-H	57
2-39302-H	143
2-39302-H-02	57
2-39302-H-02	143
2-39302-H-22	57
2-39302-H-22	143
2-39302-H-23	57
2-39302-H-23	143
2-39303	57
2-39303	143
2-39303-H	57
2-39303-H	143
2-39401	57
2-39401-H	57
2-39402	57

Art. Nr. item no.	Seite Page
2-39402-02	57
2-39402-22	57
2-39402-23	57
2-39402-H	57
2-39402-H-02	57
2-39402-H-22	57
2-39402-H-23	57
2-39403	57
2-39403-H	57
2-39601	57
2-39601-H	57
2-39602	57
2-39602-02	57
2-39602-22	57
2-39602-23	57
2-39602-H	57
2-39602-H-02	57
2-39602-H-22	57
2-39602-H-23	57
2-39603	57
2-39603-H	57
2-39801	57
2-39801-H	57
2-39802	57
2-39802-02	57
2-39802-22	57
2-39802-23	57
2-39802-H	57
2-39802-H-02	57
2-39802-H-22	57
2-39802-H-23	57
2-39803	57
2-39803-H	57
2-400101	175
2-400102	175
2-400103	175
2-400117	175
2-400130	175
2-400130-IP44	175
2-400132	175
2-400201	175
2-400202	175
2-400203	175
2-400217	175
2-400230	175
2-400230-IP44	175
2-400232	175
2-4018002-30	427
2-4018002-31	427
2-4018002-32	427
2-4018002-33	427
2-4028002-30	433
2-4028002-31	433
2-4028002-32	433
2-4028002-33	433
2-402801	27
2-402801-H	27
2-402802	27
2-402802-02	27
2-402802-22	27
2-402802-23	27
2-402802-H	27
2-402802-H-02	27
2-402802-H-22	27
2-402802-H-23	27
2-402803	27
2-402803-H	27
2-4038002-30	433
2-4038002-31	433
2-4038002-32	433
2-4038002-33	433
2-40801	123
2-40801-H	123
2-40802	123
2-40802-02	123
2-40802-22	123
2-40802-23	123
2-40802-H	123
2-40802-H-02	123
2-40802-H-22	123
2-40802-H-23	123
2-40803	123
2-40803-H	123
2-40812-30	443
2-40812-31	443
2-40812-32	443
2-40812-33	443
24-170201	171

Produktübersicht Product Overview

Art. Nr. item no.	Seite Page
2-48012-30	441
2-48012-31	441
2-48012-32	441
2-48012-33	441
2-48112-30	425
2-48112-31	425
2-48112-32	425
2-48112-33	425
2-48212-30	431
2-48212-31	431
2-48212-32	431
2-48212-33	431
2-50721	61
2-50721	147
2-50721-H	61
2-50721-H	147
2-50722	61
2-50722	147
2-50722-02	61
2-50722-02	147
2-50722-22	61
2-50722-22	147
2-50722-23	61
2-50722-23	147
2-50722-H	61
2-50722-H	147
2-50722-H-02	61
2-50722-H-02	147
2-50722-H-22	61
2-50722-H-22	147
2-50722-H-23	61
2-50722-H-23	147
2-50723	61
2-50723	147
2-50723-H	61
2-50723-H	147
2-50731	61
2-50731	147
2-50731-H	61
2-50731-H	147
2-50732	61
2-50732	147
2-50732-02	61
2-50732-02	147
2-50732-22	61
2-50732-22	147
2-50732-23	61
2-50732-23	147
2-50732-H	61
2-50732-H	147
2-50732-H-02	61
2-50732-H-02	147
2-50732-H-22	61
2-50732-H-22	147
2-50732-H-23	61
2-50732-H-23	147
2-50733	61
2-50733	147
2-50733-H	61
2-50733-H	147
2-50802-30	429
2-50802-31	429
2-50802-32	429
2-50802-33	429
2-50812-30	445
2-50812-31	445
2-50812-32	445
2-50812-33	445
26-1407020	395
26-1407021	395
26-1407022	395
26-1607020	395
26-1607021	395
26-1607022	395
2-625	159
2-626	159
2-626	159
2-627	159
2-628	159
2-629	159
2-630	159
2-633	159
2-634	159
26-706020	395
26-706021	395
26-706022	395
26-907020	395
26-907021	395

Art. Nr. item no.	Seite Page
26-907022	395
27-1407020	397
27-1407021	397
27-1407022	397
27-1607020	397
27-1607021	397
27-1607022	397
27-706020	397
27-706021	397
27-706022	397
27-907020	397
27-907021	397
27-907022	397
28-1407020	393
28-1407021	393
28-1407022	393
28-1607020	393
28-1607021	393
28-1607022	393
28-806020	393
28-806021	393
28-806022	393
28-907020	393
28-907021	393
28-907022	393
2-9126	235
2-9126-S	235
29-140701	391
29-160701	391
29-80601	391
29-90701	391
3-2020101	373
3-2020102	373
3-2020103	373
3-2020105	373
3-2020114	363
3-2020114-LED	363
3-2020117	373
3-2020201	373
3-2020202	373
3-2020203	373
3-2020205	373
3-2020214	363
3-2020214-LED	363
3-2020217	373
3-2030101	373
3-2030102	373
3-2030103	373
3-2030105	373
3-2030114	363
3-2030114-LED	363
3-2030117	373
3-2030201	373
3-2030202	373
3-2030203	373
3-2030205	373
3-2030214	363
3-2030214-LED	363
3-2030217	373
3-2040101	373
3-2040102	373
3-2040103	373
3-2040105	373
3-2040117	373
3-2040201	373
3-2040202	373
3-2040203	373
3-2040205	373
3-2040217	373
3206121-LED	221
3206122-LED	221
3206123-LED	221
33-102-b	296
33-102-cr	296
33-102-s	296
33-102-w	296
33-103-b	296
33-103-cr	296
33-103-s	296
33-103-w	296
33-104-b	296
33-104-s	296
33-104-w	296
33-105-b	296
33-105-s	296
33-105-w	296
33-106-b	296
33-106-cr	296

Art. Nr. item no.	Seite Page
33-106-s	296
33-106-w	296
33-107-b	296
33-107-cr	296
33-107-s	296
33-107-w	296
33-108-b	296
33-108-cr	296
33-108-s	296
33-108-w	296
33-109-cr	296
33-110-cr	296
33-111-cr	296
33-112-b	296
33-112-cr	296
33-112-s	296
33-112-w	296
33-113-b	296
33-113-cr	296
33-113-s	296
33-113-w	296
33-114-b	296
33-114-cr	296
33-114-s	296
33-114-w	296
33-115-b	297
33-115-cr	297
33-115-s	297
33-115-w	297
33-116-b	297
33-116-cr	297
33-116-s	297
33-116-w	297
33-117-b	297
33-117-cr	297
33-117-s	297
33-117-w	297
33-118-b	297
33-118-cr	297
33-118-s	297
33-118-w	297
33-119-b	297
33-119-cr	297
33-119-s	297
33-119-w	297
33-120-b	297
33-120-cr	297
33-120-s	297
33-120-w	297
33-121-b	297
33-121-cr	297
33-121-s	297
33-121-w	297
33-122-b	297
33-122-cr	297
33-122-s	297
33-122-w	297
33-123-b	297
33-123-cr	297
33-123-s	297
33-123-w	297
3-32201-01	181
3-32201-02	181
3-32201-03	181
3-32201-05	181
3-3220114	179
3-3220114-LED	179
3-32201-17	181
3-32202-01	181
3-32202-02	181
3-32202-03	181
3-32202-05	181
3-3220214	179
3-3220214-LED	179
3-32202-17	181
3-32301-01	181
3-32301-02	181
3-32301-03	181
3-32301-05	181
3-3230114	179
3-3230114-LED	179
3-32301-17	181
3-32302-01	181
3-32302-02	181
3-32302-03	181
3-32302-05	181
3-3230214	179
3-3230214-LED	179

Art. Nr. item no.	Seite Page
3-32302-17	181
3-32401-01	181
3-32401-02	181
3-32401-03	181
3-32401-05	181
3-3240114	179
3-3240114-LED	179
3-32401-17	181
3-32402-01	181
3-32402-02	181
3-32402-03	181
3-32402-05	181
3-3240214	179
3-3240214-LED	179
3-32402-17	181
3-4020101	173
3-4020102	173
3-4020103	173
3-4020105	173
3-4020114	149
3-4020114-LED	149
3-4020117	173
3-4020201	173
3-4020202	173
3-4020203	173
3-4020205	173
3-4020214	149
3-4020214-LED	149
3-4020217	173
3-4030101	173
3-4030102	173
3-4030103	173
3-4030105	173
3-4030114	149
3-4030114-LED	149
3-4030117	173
3-4030201	173
3-4030202	173
3-4030203	173
3-4030205	173
3-4030214	149
3-4030214-LED	149
3-4030217	173
3-4040101	173
3-4040102	173
3-4040103	173
3-4040105	173
3-4040117	173
3-4040201	173
3-4040202	173
3-4040203	173
3-4040205	173
3-4040217	173
3-4120101	173
3-4120102	173
3-4120103	173
3-4120105	173
3-4120114	149
3-4120114-LED	149
3-4120117	173
3-4120201	173
3-4120202	173
3-4120203	173
3-4120205	173
3-4120214	149
3-4120214-LED	149
3-4120217	173
3-4130101	173
3-4130102	173
3-4130103	173
3-4130105	173
3-4130114	149
3-4130114-LED	149
3-4130117	173
3-4130201	173
3-4130202	173
3-4130203	173
3-4130205	173
3-4130214	149
3-4130214-LED	149
3-4130217	173
3-4140101	173
3-4140102	173
3-4140103	173
3-4140105	173
3-4140117	173
3-4140201	173
3-4140202	173

Art. Nr. item no.	Seite Page
3-4140203	173
3-4140205	173
3-4140217	173
3-7020101	289
3-7020102	289
3-7020103	289
3-7020105	289
3-7020114	283
3-7020114-LED	283
3-7020117	289
3-7020201	289
3-7020202	289
3-7020203	289
3-7020205	289
3-7020214	283
3-7020214-LED	283
3-7020217	289
3-7030101	289
3-7030102	289
3-7030103	289
3-7030105	289
3-7030114	283
3-7030114-LED	283
3-7030117	289
3-7030201	289
3-7030202	289
3-7030203	289
3-7030205	289
3-7030214	283
3-7030214-LED	283
3-7030217	289
3-7040101	289
3-7040102	289
3-7040103	289
3-7040105	289
3-7040117	289
3-7040201	289
3-7040202	289
3-7040203	289
3-7040205	289
3-7040217	289
4-04621	107
4-04621-LED	107
4-04622	107
4-04622-LED	107
4-04651	103
4-04651-LED	103
4-04652	103
4-04652-LED	103
4-05621	107
4-05621-LED	107
4-05622	107
4-05622-LED	107
4-05628	107
4-05629	107
4-05651	103
4-05651-LED	103
4-05652	103
4-05652-LED	103
4-05658	103
4-05659	103
4-06620	105
4-06650	101
4-07621	105
4-07651	101
5-0600-02-MT-B	302
5-06001	193
5-06001-H	193
5-06001-MT-C	302
5-06002	193
5-06002-02	193
5-06002-22	193
5-06002-23	193
5-0600-22-MT-A	302
5-06002-H	193
5-06002-H-22	193
5-06002-H-23	193
5-06002-MT-D	302
5-06003	193
5-060031	193
5-060031-H	193
5-060032	193
5-060032-02	193
5-060032-22	193
5-060032-23	193
5-060032-H	193
5-060032-H-02	193

Art. Nr. item no.	Seite Page
5-060032-H-22	193
5-060032-H-23	193
5-060033	193
5-060033-H	193
5-06003-H	193
5-071201-6	199
5-071201-6-LED	199
5-071202-6	199
5-071202-6-02	199
5-071202-6-22	199
5-071202-6-23	199
5-071202-6-LED	199
5-071202-6-LED-02	199
5-071202-6-LED-22	199
5-071202-6-LED-23	199
5-071203-6	199
5-071203-6-LED	199
5-07651	231
5-07651-MT-D	303
5-07652	231
5-07801-4	199
5-07801-4-LED	199
5-07802-4	199
5-07802-4-02	199
5-07802-4-22	199
5-07802-4-23	199
5-07802-4-LED	199
5-07802-4-LED-02	199
5-07802-4-LED-22	199
5-07802-4-LED-23	199
5-07803-4	199
5-07803-4-LED	199
5-07951	231
5-0800-02-1-LED-MT-B	301
5-08001-1	187
5-08001-1-LED	187
5-08001-1-LED-MT-C	301
5-08001-2	187
5-08001-2-LED	187
5-08002-1	187
5-08002-1-02	187
5-08002-1-22	187
5-08002-1-23	187
5-08002-1-LED	187
5-08002-1-LED-02	187
5-08002-1-LED-22	187
5-08002-1-LED-23	187
5-08002-1-LED-MT-D	301
5-08002-2	187
5-08002-2-02	187
5-0800-22-1-LED-MT-A	301
5-08002-2-22	187
5-08002-2-23	187
5-08002-2-LED	187
5-08002-2-LED-02	187
5-08002-2-LED-22	187
5-08002-2-LED-23	187
5-08003-1	187
5-08003-1-LED	187
5-08003-2	187
5-08003-2-LED	187
5-08006-1	187
5-08006-1-LED	187
5-08006-2	187
5-08006-2-LED	187
5-0811001-2	63
5-0811001-2-LED	63
5-0811002-2	63
5-0811002-2-02	63
5-0811002-2-22	63
5-0811002-2-23	63
5-0811002-2-LED	63
5-0811002-2-LED-02	63
5-0811002-2-LED-22	63
5-0811002-2-LED-23	63
5-0811003-2	63
5-0811003-2-LED	63
5-0811201-2	63
5-0811201-2-LED	63
5-0811202-2	63
5-0811202-2-02	63
5-0811202-2-22	63
5-0811202-2-23	63
5-0811202-2-LED	63
5-0811202-2-LED-02	63
5-0811202-2-LED-22	63
5-0811202-2-LED-23	63
5-0811203-2	63

Produktübersicht Product Overview

Art. Nr. item no.	Seite Page
5-0811203-2-LED	63
5-081201-2	63
5-081201-2-LED	63
5-081202-2	63
5-081202-2-02	63
5-081202-2-22	63
5-081202-2-23	63
5-081202-2-LED	63
5-081202-2-LED-02	63
5-081202-2-LED-22	63
5-081202-2-LED-23	63
5-081203-2	63
5-081203-2-LED	63
5-081401-2	63
5-081401-2-LED	63
5-081402-2	63
5-081402-2-02	63
5-081402-2-22	63
5-081402-2-23	63
5-081402-2-LED	63
5-081402-2-LED-02	63
5-081402-2-LED-22	63
5-081402-2-LED-23	63
5-081403-2	63
5-081403-2-LED	63
5-081601-2	63
5-081601-2-LED	63
5-081602-2	63
5-081602-2-02	63
5-081602-2-22	63
5-081602-2-23	63
5-081602-2-LED	63
5-081602-2-LED-02	63
5-081602-2-LED-22	63
5-081602-2-LED-23	63
5-081603-2	63
5-081603-2-LED	63
5-081801-2	63
5-081801-2-LED	63
5-081802-2	63
5-081802-2-02	63
5-081802-2-22	63
5-081802-2-23	63
5-081802-2-LED	63
5-081802-2-LED-02	63
5-081802-2-LED-22	63
5-081802-2-LED-23	63
5-081803-2	63
5-081803-2-LED	63
5-08651	231
5-08651-MT-D	303
5-08652	231
5-3600-02-MT-B	302
5-36001	195
5-36001-H	195
5-36001-MT-C	302
5-36002	195
5-36002-02	195
5-36002-22	195
5-36002-23	195
5-3600-22-MT-A	302
5-36002-H	195
5-36002-H-02	195
5-36002-H-22	195
5-36002-H-23	195
5-36002-MT-D	302
5-36003	195
5-360031	195
5-360031-H	195
5-360032	195
5-360032-02	195
5-360032-22	195
5-360032-23	195
5-360032-H	195
5-360032-H-02	195
5-360032-H-22	195
5-360032-H-23	195
5-360033	195
5-360033-H	195
5-36003-H	195
5-371201-6	201
5-371201-6-H	201
5-371202-6	201
5-371202-6-02	201
5-371202-6-22	201
5-371202-6-23	201
5-371202-6-H	201
5-371202-6-H-02	201

Art. Nr. item no.	Seite Page
5-371202-6-H-22	201
5-371202-6-H-23	201
5-371203-6	201
5-371203-6-H	201
5-37801-4	201
5-37801-4-H	201
5-37802-4	201
5-37802-4-02	201
5-37802-4-22	201
5-37802-4-23	201
5-37802-4-H	201
5-37802-4-H-02	201
5-37802-4-H-22	201
5-37802-4-H-23	201
5-37803-4	201
5-37803-4-H	201
5-3800-02-MT-B	301
5-38001	189
5-38001-H	189
5-38001-MT-C	301
5-38002	189
5-38002-02	189
5-38002-22	189
5-38002-23	189
5-3800-22-MT-A	301
5-38002-H	189
5-38002-H-02	189
5-38002-H-22	189
5-38002-H-23	189
5-38002-MT-D	301
5-38003	189
5-38003-H	189
5-38006	189
5-38006-H	189
5-38021	189
5-38021-H	189
5-38022	189
5-38022-02	189
5-38022-22	189
5-38022-23	189
5-38022-H	189
5-38022-H-02	189
5-38022-H-22	189
5-38022-H-23	189
5-38023	189
5-38023-H	189
5-38026	189
5-38026-H	189
5-3811001-2	65
5-3811001-2-H	65
5-3811002-2	65
5-3811002-2-02	65
5-3811002-2-22	65
5-3811002-2-23	65
5-3811002-2-H	65
5-3811002-2-H-02	65
5-3811002-2-H-22	65
5-3811002-2-H-23	65
5-3811003-2	65
5-3811003-2-H	65
5-3811201-2	65
5-3811201-2-H	65
5-3811202-2	65
5-3811202-2-02	65
5-3811202-2-22	65
5-3811202-2-23	65
5-3811202-2-H	65
5-3811202-2-H-02	65
5-3811202-2-H-22	65
5-3811202-2-H-23	65
5-381203-2	65
5-381203-2-H	65
5-381401-2	65
5-381401-2-H	65
5-381402-2	65
5-381402-2-02	65

Art. Nr. item no.	Seite Page
5-381402-2-22	65
5-381402-2-23	65
5-381402-2-H	65
5-381402-2-H-02	65
5-381402-2-H-22	65
5-381402-2-H-23	65
5-381403-2	65
5-381403-2-H	65
5-381601-2	65
5-381601-2-H	65
5-381602-2	65
5-381602-2-02	65
5-381602-2-22	65
5-381602-2-23	65
5-381602-2-H	65
5-381602-2-H-02	65
5-381602-2-H-22	65
5-381602-2-H-23	65
5-381603-2	65
5-381603-2-H	65
5-381801-2	65
5-381801-2-H	65
5-381802-2	65
5-381802-2-02	65
5-381802-2-22	65
5-381802-2-23	65
5-381802-2-H	65
5-381802-2-H-02	65
5-381802-2-H-22	65
5-381802-2-H-23	65
5-381803-2	65
5-381803-2-H	65
5-50001	191
5-50001-H	191
5-50002	191
5-50002-02	191
5-50002-22	191
5-50002-23	191
5-50002-H	191
5-50002-H-02	191
5-50002-H-22	191
5-50002-H-23	191
5-50003	191
5-50003-H	191
5-56001	197
5-56001-H	197
5-56002	197
5-56002-02	197
5-56002-22	197
5-56002-23	197
5-56002-H	197
5-56002-H-02	197
5-56002-H-22	197
5-56002-H-23	197
5-56003	197
5-560031	197
5-560031-H	197
5-560032	197
5-560032-02	197
5-560032-22	197
5-560032-23	197
5-560032-H	197
5-560032-H-02	197
5-560032-H-22	197
5-560032-H-23	197
5-560033	197
5-560033-H	197
5-56003-H	197
5-911-02-MT-B	303
5-911-1	235
5-911-1-IP	235
5-911-1-MT-C	303
5-911-2	235
5-911-2-02	235
5-911-2-22	235
5-911-2-23	235
5-911-22-MT-A	303
5-911-2-IP	235
5-911-2-IP-02	235
5-911-2-IP-22	235
5-911-2-IP-23	235
5-911-2-MT-D	303
5-9113-1	235
5-9113-1-IP	235
5-9113-2	235
5-9113-2-02	235
5-9113-2-22	235
5-9113-2-23	235

Art. Nr. item no.	Seite Page
5-9113-2-IP	235
5-9113-2-IP-02	235
5-9113-2-IP-22	235
5-9113-2-IP-23	235
6-081201-1-G9	247
6-081201-1-NV-LED	247
6-081201-2-G9	247
6-081201-2-NV-LED	247
6-081202-1-02-G9	247
6-081202-1-22-G9	247
6-081202-1-23-G9	247
6-081202-1-G9	247
6-081202-1-NV-LED	247
6-081202-1-NV-LED-02	247
6-081202-1-NV-LED-22	247
6-081202-1-NV-LED-23	247
6-081202-2-02-G9	247
6-081202-2-22-G9	247
6-081202-2-23-G9	247
6-081202-2-G9	247
6-081202-2-NV-LED	247
6-081202-2-NV-LED-02	247
6-081202-2-NV-LED-22	247
6-081202-2-NV-LED-23	247
6-081203-1-G9	247
6-081203-1-NV-LED	247
6-081203-2-G9	247
6-081203-2-NV-LED	247
6-0813201-G9	241
6-0813201-NV-LED	241
6-0813202-02-G9	241
6-0813202-22-G9	241
6-0813202-23-G9	241
6-0813202-G9	241
6-0813202-NV-LED	241
6-0813202-NV-LED-02	241
6-0813202-NV-LED-22	241
6-0813202-NV-LED-23	241
6-0813203-G9	241
6-0813203-NV-LED	241
6-081801-1-G9	255
6-081801-1-NV-LED	255
6-081801-2-G9	255
6-081801-2-NV-LED	255
6-081802-1-02-G9	255
6-081802-1-22-G9	255
6-081802-1-23-G9	255
6-081802-1-G9	255
6-081802-1-NV-LED	255
6-081802-1-NV-LED-02	255
6-081802-1-NV-LED-22	255
6-081802-1-NV-LED-23	255
6-081802-2-02-G9	255
6-081802-2-22-G9	255
6-081802-2-23-G9	255
6-081802-2-G9	255
6-081802-2-NV-LED	255
6-081802-2-NV-LED-02	255
6-081802-2-NV-LED-22	255
6-081803-1-G9	255
6-081803-1-NV-LED	255
6-081803-2-G9	255
6-081803-2-NV-LED	255
6-081807-2-NV-LED-23	255
6-0821201-G9	251
6-0821201-NV-LED	251
6-0821202-02-G9	251
6-0821202-22-G9	251
6-0821202-23-G9	251
6-0821202-G9	251
6-0821202-NV-LED	251
6-0821202-NV-LED-02	251
6-0821202-NV-LED-22	251
6-0821202-NV-LED-23	251
6-0821203-G9	251
6-0821203-NV-LED	251
6-082180120-1-G9	259
6-082180120-1-NV-LED	259
6-082180120-2-02-G9	259
6-082180120-2-22-G9	259
6-082180120-2-23-G9	259
6-082180120-2-G9	259
6-082180120-2-NV-LED	259
6-082180120-2-NV-LED-02	259
6-082180120-2-NV-LED-22	259
6-082180120-2-NV-LED-23	259
6-082180120-3-G9	259
6-082180120-3-NV-LED	259

Art. Nr. item no.	Seite Page
6-083701-G9	273
6-083701-NV-LED	273
6-083702-02-G9	273
6-083702-22-G9	273
6-083702-23-G9	273
6-083702-G9	273
6-083702-NV-LED	273
6-083702-NV-LED-02	273
6-083702-NV-LED-22	273
6-083702-NV-LED-23	273
6-083703-G9	273
6-083703-NV-LED	273
6-084701-G9	273
6-084701-NV-LED	273
6-084702-02-G9	273
6-084702-22-G9	273
6-084702-23-G9	273
6-084702-G9	273
6-084702-NV-LED	273
6-084702-NV-LED-02	273
6-084702-NV-LED-22	273
6-084702-NV-LED-23	273
6-084703-G9	273
6-084703-NV-LED	273
6-08601-1-G9	279
6-08601-1-NV-LED	279
6-08601-2-G9	279
6-08601-2-NV-LED	279
6-08602-1-02-G9	279
6-08602-1-22-G9	279
6-08602-1-23-G9	279
6-08602-1-G9	279
6-08602-1-NV-LED	279
6-08602-1-NV-LED-02	279
6-08602-1-NV-LED-22	279
6-08602-1-NV-LED-23	279
6-08602-2-02-G9	279
6-08602-2-22-G9	279
6-08602-2-23-G9	279
6-08602-2-G9	279
6-08602-2-NV-LED	279
6-08602-2-NV-LED-02	279
6-08602-2-NV-LED-22	279
6-08602-2-NV-LED-23	279
6-08603-1-G9	279
6-08603-1-NV-LED	279
6-08603-2-G9	279
6-08603-2-NV-LED	279
6-08801-1-G9	279
6-08801-1-NV-LED	279
6-08801-2-G9	279
6-08801-2-NV-LED	279
6-08802-1-02-G9	279
6-08802-1-22-G9	279
6-08802-1-23-G9	279
6-08802-1-G9	279
6-08802-1-NV-LED	279
6-08802-1-NV-LED-02	279
6-08802-1-NV-LED-22	279
6-08802-1-NV-LED-23	279
6-08802-2-02-G9	279
6-08802-2-22-G9	279
6-08802-2-23-G9	279
6-08802-2-G9	279
6-08802-2-NV-LED	279
6-08802-2-NV-LED-02	279
6-08802-2-NV-LED-22	279
6-08802-2-NV-LED-23	279
6-08803-1-G9	279
6-08803-1-NV-LED	279
6-08803-2-G9	279
6-08803-2-NV-LED	279
6-24060343	287
6-24060344	287
6-24060347	287
6-24070303	287
6-24070304	287
6-24070305	287
6-381201-G9	249
6-381201-NV-LED	249
6-381202-02-G9	249
6-381202-22-G9	249
6-381202-23-G9	249
6-381202-G9	249
6-381202-NV-LED	249
6-381202-NV-LED-02	249
6-381202-NV-LED-22	249
6-381202-NV-LED-23	249
6-381202-3-G9	249
6-381202-NV-LED-23	249

Art. Nr. item no.	Seite Page
6-381203-G9	249
6-381203-NV-LED	249
6-3813201-G9	243
6-3813201-NV-LED	243
6-3813202-02-G9	243
6-3813202-22-G9	243
6-3813202-23-G9	243
6-3813202-G9	243
6-3813202-NV-LED	243
6-3813202-NV-LED-02	243
6-3813202-NV-LED-22	243
6-3813202-NV-LED-23	243
6-3813203-G9	243
6-3813203-NV-LED	243
6-381801-G9	257
6-381801-NV-LED	257
6-381802-02-G9	257
6-3818021-G9	257
6-3818021-NV-LED	257
6-3818022-02-G9	257
6-3818022-22-G9	257
6-3818022-23-G9	257
6-381802-22-G9	257
6-381802-23-G9	257
6-3818022-G9	257
6-3818022-NV-LED	257
6-3818022-NV-LED-02	257
6-3818022-NV-LED-22	257
6-3818022-NV-LED-23	257
6-3818023-G9	257
6-3818023-NV-LED	257
6-381802-G9	257
6-381802-NV-LED	257
6-381802-NV-LED-02	257
6-381802-NV-LED-22	257
6-3818022-NV-LED-23	257
6-3818023-G9	257
6-3818023-NV-LED	257
6-381802-G9	257
6-381802-NV-LED	257
6-381802-NV-LED-02	257
6-381802-NV-LED-22	257
6-381802-NV-LED-23	257
6-381802-G9	257
6-381802-NV-LED	257
6-381802-NV-LED-02	257
6-381802-NV-LED-22	257
6-381802-NV-LED-23	257
6-381803-NV-LED	257
6-3821201-G9	253
6-3821201-NV-LED	253
6-3821202-02-G9	253
6-3821202-22-G9	253
6-3821202-23-G9	253
6-3821202-G9	253
6-3821202-NV-LED	253
6-3821202-NV-LED-02	253
6-3821202-NV-LED-22	253
6-3821202-NV-LED-23	253
6-3821203-G9	253
6-3821203-NV-LED	253
6-3821801201-G9	261
6-3821801201-NV-LED	261
6-3821801202-02-G9	261
6-3821801202-22-G9	261
6-3821801202-23-G9	261
6-3821801202-G9	261
6-3821801202-NV-LED	261
6-3821801202-NV-LED-02	261
6-3821801202-NV-LED-22	261
6-3821801202-NV-LED-23	261
6-3821801203-G9	261
6-3821801203-NV-LED	261
6-383701-G9	275
6-383701-NV-LED	275
6-383702-02-G9	275
6-383702-22-G9	275
6-383702-23-G9	275
6-383702-G9	275
6-383702-NV-LED	275
6-383702-NV-LED-02	275
6-383702-NV-LED-22	275
6-383702-NV-LED-23	275
6-383703-G9	275
6-383703-NV-LED	275
6-384701-G9	275
6-384701-NV-LED	275
6-384702-02-G9	275
6-384702-22-G9	275
6-384702-23-G9	275
6-384702-G9	275
6-384702-NV-LED	275
6-384702-NV-LED-02	275
6-384702-NV-LED-22	275
6-384702-NV-LED-23	275
6-384703-G9	275
6-384703-NV-LED	275
6-38601-G9	281
6-38601-NV-LED	281

Produktübersicht Product Overview

Art. Nr. item no.	Seite Page
6-38602-02-G9	281
6-38602-22-G9	281
6-38602-23-G9	281
6-38602-G9	281
6-38602-NV-LED	281
6-38602-NV-LED-02	281
6-38602-NV-LED-22	281
6-38602-NV-LED-23	281
6-38603-G9	281
6-38603-NV-LED	281
6-38801-G9	281
6-38801-NV-LED	281
6-38802-02-G9	281
6-38802-22-G9	281
6-38802-23-G9	281
6-38802-G9	281
6-38802-NV-LED	281
6-38802-NV-LED-02	281
6-38802-NV-LED-22	281
6-38802-NV-LED-23	281
6-38803-G9	281
6-38803-NV-LED	281
6-4013201-G9	245
6-4013201-NV-LED	245
6-4013202-02-G9	245
6-4013202-22-G9	245
6-4013202-23-G9	245
6-4013202-G9	245
6-4013202-NV-LED	245
6-4013202-NV-LED	245
6-4013202-NV-LED-02	245
6-4013202-NV-LED-22	245
6-4013203-G9	245
6-4013203-NV-LED	245
6-403701-G9	277
6-403701-NV-LED	277
6-403702-02-G9	277
6-403702-22-G9	277
6-403702-23-G9	277
6-403702-G9	277
6-403702-NV-LED	277
6-403702-NV-LED-02	277
6-403702-NV-LED-22	277
6-403702-NV-LED-23	277
6-403703-G9	277
6-403703-NV-LED	277
6-404701-G9	277
6-404701-NV-LED	277
6-404702-02-G9	277
6-404702-22-G9	277
6-404702-23-G9	277
6-404702-G9	277
6-404702-NV-LED	277
6-404702-NV-LED-02	277
6-404702-NV-LED-22	277
6-404702-NV-LED-23	277
6-404703-G9	277
6-404703-NV-LED	277
6-901401	269
6-901401-H	269
6-901402	269
6-901402-02	269
6-901402-22	269
6-901402-23	269
6-901402-H	269
6-901402-H-02	269
6-901402-H-22	269
6-901402-H-23	269
6-901403	269
6-901403-H	269
6-981401	271
6-981401-H	271
6-981402	271
6-981402-02	271
6-981402-22	271
6-981402-23	271
6-981402-H	271
6-981402-H-02	271
6-981402-H-22	271
6-981402-H-23	271
6-981403	271
6-981403-H	271
7-06629	105
7-06659	101
7-2201211	85
7-2201211	161
7-2201212	85
7-2201212	161

Art. Nr. item no.	Seite Page
7-2201212-02	85
7-2201212-02	161
7-2201212-22	85
7-2201212-22	161
7-2201212-23	85
7-2201212-23	161
7-2201213	85
7-2201213	161
7-2201611	85
7-2201611	161
7-2201612	85
7-2201612	161
7-2201612-02	85
7-2201612-02	161
7-2201612-22	85
7-2201612-22	161
7-2201612-23	85
7-2201612-23	161
7-2201613	85
7-2201613	161
7-2202411	85
7-2202411	161
7-2202412	85
7-2202412	161
7-2202412-02	85
7-2202412-02	161
7-2202412-22	85
7-2202412-22	161
7-2202412-23	85
7-2202412-23	161
7-2202413	85
7-2202413	161
7-2221211	87
7-2221212	87
7-2221212-02	87
7-2221212-22	87
7-2221212-23	87
7-2221213	87
7-2221611	87
7-2221612	87
7-2221612-02	87
7-2221612-22	87
7-2221612-23	87
7-2221613	87
7-2222411	87
7-2222412	87
7-2222412-02	87
7-2222412-22	87
7-2222412-23	87
7-2222413	87
7-2231211	347
7-2231212	347
7-2231212-02	347
7-2231212-22	347
7-2231212-23	347
7-2231213	347
7-2231611	347
7-2231612	347
7-2231612-02	347
7-2231612-22	347
7-2231612-23	347
7-2231613	347
7-2232411	347
7-2232412	347
7-2232412-02	347
7-2232412-22	347
7-2232412-23	347
7-2232413	347
7-2241211	347
7-2241212	347
7-2241212-02	347
7-2241212-22	347
7-2241212-23	347
7-2241213	347
7-2241611	347
7-2241612	347
7-2241612-02	347
7-2241612-22	347
7-2241612-23	347
7-2241613	347
7-2242411	347
7-2242412	347
7-2242412-02	347
7-2242412-22	347
7-2242412-23	347
7-2242413	347
7-2421212	435
7-2421612	435

Art. Nr. item no.	Seite Page
7-2422412	435
7-32513011	93
7-32513012	93
7-32513012-02	93
7-32513012-22	93
7-32513012-23	93
7-32513013	93
7-32521011	93
7-32521012	93
7-32521012-02	93
7-32521012-22	93
7-32521012-23	93
7-32521013	93
7-3259011	93
7-3259012	93
7-3259012-02	93
7-3259012-22	93
7-3259012-23	93
7-3259013	93
7-3261301-02-MT-B	304
7-32613011	93
7-32613011-MT-C	304
7-32613012	93
7-32613012-02	93
7-32613012-22	93
7-32613012-23	93
7-3261301-22-MT-A	304
7-32613012-MT-D	304
7-32613013	93
7-32621011	93
7-32621012	93
7-32621012-02	93
7-32621012-22	93
7-32621012-23	93
7-32621013	93
7-326901-02-MT-B	304
7-3269011	93
7-3269011-MT-C	304
7-3269012	93
7-3269012-02	93
7-3269012-22	93
7-3269012-23	93
7-326901-22-MT-A	304
7-3269012-MT-D	304
7-3269013	93
7-32713011	225
7-32713012	225
7-32713012-02	225
7-32713012-22	225
7-32713012-23	225
7-32713013	225
7-32721011	225
7-32721012	225
7-32721012-02	225
7-32721012-22	225
7-32721012-23	225
7-32721013	225
7-3279011	225
7-3279012	225
7-3279012-02	225
7-3279012-22	225
7-3279012-23	225
7-3279013	225
7-3281301-02-MT-B	305
7-32813011	225
7-32813011-MT-C	305
7-32813012	225
7-32813012-02	225
7-32813012-22	225
7-32813012-23	225
7-3281301-22-MT-A	305
7-32813012-MT-D	305
7-32813013	225
7-32821011	225
7-32821012	225
7-32821012-02	225
7-32821012-22	225
7-32821012-23	225
7-32821013	225
7-328901-02-MT-B	304
7-3289011	225
7-3289011-MT-C	304
7-3289012	225
7-3289012-02	225
7-3289012-22	225
7-3289012-23	225
7-328901-22-MT-A	304
7-3289012-MT-D	304

Art. Nr. item no.	Seite Page
7-3289013	225
7-32913011	285
7-32913012	285
7-32913012-02	285
7-32913012-22	285
7-32913012-23	285
7-32913013	285
7-3299011	285
7-3299012	285
7-3299012-02	285
7-3299012-22	285
7-3299012-23	285
7-3299013	285
7-33013011	285
7-33013012	285
7-33013012-02	285
7-33013012-22	285
7-33013012-23	285
7-33013013	285
7-33021011	285
7-33021012	285
7-33021012-02	285
7-33021012-22	285
7-33021012-23	285
7-33021013	285
7-3309011	285
7-3309012	285
7-3309012-02	285
7-3309012-22	285
7-3309012-23	285
7-3309013	285
7-33121011	285
7-33121012	285
7-33121012-02	285
7-33121012-22	285
7-33121012-23	285
7-33121013	285
7-33213011	263
7-33213012	263
7-33213012-02	263
7-33213012-22	263
7-33213012-23	263
7-33213013	263
7-33221011	263
7-33221012	263
7-33221012-02	263
7-33221012-22	263
7-33221012-23	263
7-33221013	263
7-3329011	263
7-3329012	263
7-3329012-02	263
7-3329012-22	263
7-3329012-23	263
7-3329013	263
7-33313011	263
7-33313012	263
7-33313012-02	263
7-33313012-22	263
7-33313012-23	263
7-33313013	263
7-33321011	263
7-33321012	263
7-33321012-02	263
7-33321012-22	263
7-33321012-23	263
7-33321013	263
7-3339011	263
7-3339012	263
7-3339012-02	263
7-3339012-22	263
7-3339012-23	263
7-3339013	263
7-33421011	265
7-33421012	265
7-33421012-02	265
7-33421012-22	265
7-33421012-23	265
7-33421013	265
7-33521011	265
7-33521012	265
7-33521012-02	265
7-33521012-22	265
7-33521012-23	265
7-33521013	265
7-46120010	91
7-46130010	91
7-46140010	91

Art. Nr. item no.	Seite Page
7-46150010	91
7-46220010	91
7-46230010	91
7-46240010	91
7-46250010	91
7-46320010	89
7-46330010	89
7-46340010	89
7-46350010	89
7-46420010	89
7-46430010	89
7-46440010	89
7-46450010	89
7-46620010	229
7-46630010	229
7-46640010	229
7-46650010	229
7-47120010	437
7-47130010	437
7-47150010	437
7-47220010	437
7-47230010	437
7-47240010	437
7-47250010	437
7-47320010	439
7-47330010	439
7-47340010	439
7-47350010	439
7-47420010	439
7-47430010	439
7-47440010	439
7-47450010	439
7-69001	33
7-69001-H	33
7-69002	33
7-69002-02	33
7-69002-22	33
7-69002-23	33
7-69002-H	33
7-69002-H-02	33
7-69002-H-22	33
7-69002-H-23	33
7-69003	33
7-69003-H	33
7-69301	35
7-69301-H	35
7-69302	35
7-69302-02	35
7-69302-22	35
7-69302-23	35
7-69302-H	35
7-69302-H-02	35
7-69302-H-22	35
7-69302-H-23	35
7-69303	35
7-69303-H	35
7-71001	109
7-71001-H	109
7-71002	109
7-71002-02	109
7-71002-22	109
7-71002-23	109
7-71002-H	109
7-71002-H-02	109
7-71002-H-22	109
7-71002-H-23	109
7-71003	109
7-71003-H	109
7-71301	111
7-71301-H	111
7-71302	111
7-71302-02	111
7-71302-22	111
7-71302-23	111
7-71302-H	111
7-71302-H-02	111
7-71302-H-22	111
7-71302-H-23	111
7-71303	111
7-71303-H	111
7-72001	109
7-72001-H	109
7-72002	109
7-72002-02	109
7-72002-22	109
7-72002-23	109
7-72002-H	109
7-72002-H-02	109

Art. Nr. item no.	Seite Page
7-72002-H-22	109
7-72002-H-23	109
7-72003	109
7-72003-H	109
7-72301	111
7-72301-H	111
7-72302	111
7-72302-02	111
7-72302-22	111
7-72302-23	111
7-72302-H	111
7-72302-H-02	111
7-72302-H-22	111
7-72302-H-23	111
7-72303	111
7-72303-H	111
7-73001	109
7-73001-H	109
7-73002	109
7-73002-02	109
7-73002-22	109
7-73002-23	109
7-73002-H	109
7-73002-H-02	109
7-73002-H-22	109
7-73002-H-23	109
7-73003	109
7-73003-H	109
7-73301	111
7-73301-H	111
7-73302	111
7-73302-02	111
7-73302-22	111
7-73302-23	111
7-73302-H	111
7-73302-H-02	111
7-73302-H-22	111
7-73302-H-23	111
7-73303	111
7-73303-H	111
7-7500-02-MT-B	299
7-75001	37
7-75001-H	37
7-75001-MT-C	299
7-75002	37
7-75002-02	37
7-75002-22	37
7-75002-23	37
7-7500-22-MT-A	299
7-75002-H	37
7-75002-H-02	37
7-75002-H-22	37
7-75002-H-23	37
7-75002-MT-D	299
7-75003	37
7-75003-H	37
7-753001	39
7-753001-H	39
7-753002	39
7-753002-02	39
7-753002-22	39
7-753002-23	39
7-753002-H	39
7-753002-H-02	39
7-753002-H-22	39
7-753002-H-23	39
7-753003	39
7-753003-H	39
7-755001	41
7-755001-H	41
7-755002	41
7-755002-02	41
7-755002-22	41
7-755002-23	41
7-755002-H	41
7-755002-H-02	41
7-755002-H-22	41
7-755002-H-23	41
7-755003	41
7-755003-H	41
7-90100-BE	83
7-90100-WE	83
7-90101	83
7-90102	83
7-90102-02	83
7-90102-22	83
7-90102-23	83
7-90103	83

Produktübersicht Product Overview

Art. Nr. item n o.	Seite Page
7-971	7
7-972	7
7-973	7
7-974	7
7-978	7
7-979	7
8-020461-H	219
8-020461-LED	219
8-020462-H	219
8-020462-LED	219
8-020463-H	219
8-020463-LED	219
8-0206121-H	221
8-0206121-LED	221
8-0206122-H	221
8-0206122-LED	221
8-0206123-H	221
8-0206123-LED	221
8-0208241-H	223
8-0208241-LED	223
8-0208242-H	223
8-0208242-LED	223
8-0208243-H	223
8-0208243-LED	223
8-050341-H	211
8-050341-LED	211
8-050342-H	211
8-050342-LED	211
8-050343-H	211
8-050343-LED	211
8-050471-H	213
8-050471-LED	213
8-050472-H	213
8-050472-LED	213
8-050473-H	213
8-050473-LED	213
8-0506111-H	215
8-0506111-LED	215
8-0506112-H	215
8-0506112-LED	215
8-0506113-H	215
8-0506113-LED	215
8-0513111-H	217
8-0513111-LED	217
8-0513112-H	217
8-0513112-LED	217
8-0513113-H	217
8-0513113-LED	217
8-0601201	314
8-0601202	314
8-0601203	314
8-060301	314
8-060302	314
8-060303	314
8-060501	314
8-060502	314
8-060503	314
8-0611	314
8-0612	314
8-0613	314
8-0621	315
8-0622	315
8-0623	315
8-06411	315
8-06412	315
8-06413	315
8-06421	315
8-06422	315
8-06423	315
8-06431	315
8-06432	315
8-06433	315
8-06531	335
8-06532	335
8-06533	335
8-0661	315
8-066120	315
8-066150	315
8-0662	315
8-066220	315
8-066250	315
8-0663	315
8-066320	315
8-066350	315
8-0671	315
8-0672	315
8-0673	315
8-0681	315

Art. Nr. item no.	Seite Page
8-0682	315
8-0683	315
8-0691	315
8-0692	315
8-0693	315
8-0701201	314
8-0701201	326
8-0701202	314
8-0701202	326
8-0701203	314
8-0701203	326
8-070601	314
8-070601	326
8-070602	314
8-070602	326
8-070603	314
8-070603	326
8-0721	326
8-0722	326
8-0723	326
8-0731	314
8-0731	326
8-0732	314
8-0732	326
8-0733	314
8-0733	326
8-07501	327
8-07502	327
8-07503	327
8-0753	327
8-0761	327
8-0762	327
8-0763	327
8-0771	327
8-0772	327
8-0773	327
8-078	326
8-080301	314
8-080302	314
8-080303	314
8-0811	314
8-0811	326
8-0812	314
8-0812	326
8-0813	314
8-0813	326
8-0841	315
8-0841	326
8-0842	315
8-0842	326
8-0843	315
8-0843	326
8-0851	314
8-0852	314
8-0853	314
8-0861	314
8-0862	314
8-0863	314
8-0991	335
8-0992	335
8-0993	335
8-0994	335
8-160811-H	316
8-160811-H	329
8-160811-LED	316
8-160811-LED	329
8-160812-H	316
8-160812-H	329
8-160812-LED	316
8-160812-LED	329
8-160813-H	316
8-160813-H	329
8-160813-LED	316
8-160813-LED	329
8-160831-H	318
8-160831-LED	318
8-160832-H	318
8-160832-LED	318
8-160833-H	318
8-160833-LED	318
8-1608511-H	318
8-1608511-LED	318
8-1608512-H	318
8-1608512-LED	318
8-1608513-H	318
8-1608513-LED	318
8-1609201-H	316
8-1609201-LED	316

Art. Nr. item no.	Seite Page
8-1609202-H	316
8-1609202-LED	316
8-1609203-H	316
8-1609203-LED	316
8-1628001-H	317
8-1628001-LED	317
8-1628002-H	317
8-1628002-LED	317
8-1628003-H	317
8-1628003-LED	317
8-1638001-H	317
8-1638001-LED	317
8-1638002-H	317
8-1638002-LED	317
8-1638003-H	317
8-1638003-LED	317
8-1708401-H	329
8-1708401-LED	329
8-1708402-H	329
8-1708402-LED	329
8-1708403-H	329
8-1708403-LED	329
8-1708411-LED	329
8-1708412-LED	329
8-1708413-LED	329
8-1708601-H	329
8-1708601-LED	329
8-1708602-H	329
8-1708602-LED	329
8-1708603-H	329
8-1708603-LED	329
8-1708611-LED	329
8-1708612-LED	329
8-1708613-LED	329
8-2008001-1-H	319
8-2008001-1-LED	319
8-2008001-2-H	319
8-2008001-2-LED	319
8-2008002-1-H	319
8-2008002-1-LED	319
8-2008002-2-H	319
8-2008002-2-LED	319
8-2008003-1-H	319
8-2008003-1-LED	319
8-2008003-2-H	319
8-2008003-2-LED	319
8-205	473
8-211	473
8-309	473
8-320461-H	219
8-320461-LED	219
8-320462-H	219
8-320462-LED	219
8-320463-H	219
8-320463-LED	219
8-3206121-H	221
8-3206122-H	221
8-3206123-H	221
8-3208241-H	223
8-3208241-LED	223
8-3208242-H	223
8-3208242-LED	223
8-3208243-H	223
8-3208243-LED	223
8-331	473
8-350341-H	211
8-350341-LED	211
8-350342-H	211
8-350342-LED	211
8-350343-H	211
8-350343-LED	211
8-350471-H	213
8-350471-LED	213
8-350472-H	213
8-350472-LED	213
8-350473-H	213
8-350473-LED	213
8-3506111-H	215
8-3506111-LED	215
8-3506112-H	215
8-3506112-LED	215
8-3506113-H	215
8-3506113-LED	215
8-3513111-H	217
8-3513111-LED	217
8-3513112-H	217
8-3513112-LED	217
8-3513113-H	217

Art. Nr. item n o.	Seite Page
8-3513113-LED	217
8-360811-H	316
8-360811-H	329
8-360811-LED	316
8-360811-LED	329
8-360812-H	316
8-360812-H	329
8-360812-LED	316
8-360812-LED	329
8-360813-H	316
8-360813-H	329
8-360813-LED	316
8-360813-LED	329
8-360831-H	318
8-360831-LED	318
8-360832-H	318
8-360832-LED	318
8-360833-H	318
8-360833-LED	318
8-3608511-H	318
8-3608511-LED	318
8-3608512-H	318
8-3608512-LED	318
8-3608513-H	318
8-3608513-LED	318
8-3609201-H	316
8-3609201-LED	316
8-3609202-H	316
8-3609202-LED	316
8-3609203-H	316
8-3609203-LED	316
8-3628001-H	317
8-3628001-LED	317
8-3628002-H	317
8-3628002-LED	317
8-3628003-H	317
8-3628003-LED	317
8-3638001-H	317
8-3638001-LED	317
8-3638002-H	317
8-3638002-LED	317
8-3638003-H	317
8-3638003-LED	317
8-4008001-1-H	319
8-4008001-1-LED	319
8-4008001-2-H	319
8-4008001-2-LED	319
8-4008002-1-H	319
8-4008002-1-LED	319
8-4008002-2-H	319
8-4008002-2-LED	319
8-4008003-1-H	319
8-4008003-1-LED	319
8-4008003-2-H	319
8-4008003-2-LED	319
8-491-LED	473
8-493-LED	473
8-5007651-H	322
8-5007652-H	322
8-5008651-H	322
8-5008652-H	322
8-5032813011-LED	321
8-5032813012-LED	321
8-5032813013-LED	321
8-5032821011-LED	321
8-5032821012-LED	321
8-5032821013-LED	321
8-503289011-LED	321
8-503289012-LED	321
8-503289013-LED	321
8-50911-1-LED	323
8-50911-2-LED	323
8-50911-2-LED-02	323
8-50911-2-LED-22	323
8-524	473
8-6010041	151
8-6010041/+	153
8-6010041-H	151
8-6010041-H/+	153
8-6010042	151
8-6010042/+	153
8-6010042/+02	153
8-6010042/+22	153
8-6010042/+23	153
8-6010042-02	151
8-6010042-22	151
8-6010042-23	151
8-6010042-H	151

Art. Nr. item no.	Seite Page
8-6010042-H/+	153
8-6010042-H/+02	153
8-6010042-H/+22	153
8-6010042-H/+23	153
8-6010042-H-02	151
8-6010042-H-22	151
8-6010042-H-23	151
8-6010043	151
8-6010043/+	153
8-6010043-H	151
8-6010043-H/+	153
8-6011251	99
8-6011251	163
8-6011252	99
8-6011252	163
8-6011253	99
8-6011253	163
8-601201	365
8-601202	365
8-601203	365
8-6012041	151
8-6012041/+	153
8-6012041-H	151
8-6012041-H/+	153
8-6012042	151
8-6012042/+	153
8-6012042/+02	153
8-6012042/+22	153
8-6012042/+23	153
8-6012042-02	151
8-6012042-22	151
8-6012042-23	151
8-6012042-H	151
8-6012042-H/+	153
8-6012042-H/+02	153
8-6012042-H/+22	153
8-6012042-H/+23	153
8-6012042-H-02	151
8-6012042-H-22	151
8-6012042-H-23	151
8-6012043/+	153
8-6012043-H	151
8-6012043-H/+	153
8-601351	99
8-601351	163
8-601352	99
8-601352	163
8-601353	99
8-601353	163
8-601651	99
8-601651	163
8-601652	99
8-601652	163
8-601653	99
8-601653	163
8-601951	99
8-601951	163
8-601952	99
8-601952	163
8-601953	99
8-601953	163
8-6021251	165
8-6021252	165
8-6021253	165
8-602351	165
8-602352	165
8-602353	165
8-602651	165
8-602652	165
8-602653	165
8-602951	165
8-602952	165
8-602953	165
8-60301	365
8-60302	365
8-60303	365
8-604021	151
8-604021/+	153
8-604021-H	151
8-604021-H/+	153
8-604022	151
8-604022/+	153
8-604022/+02	153
8-604022/+22	153
8-604022/+23	153
8-604022-02	151
8-604022-22	151
8-604022-23	151

Art. Nr. item no.	Seite Page
8-604022-23	151
8-604022-H	151
8-604022-H/+	153
8-604022-H/+02	153
8-604022-H/+22	153
8-604022-H/+23	153
8-604022-H-02	151
8-604022-H-22	151
8-604022-H-23	151
8-604023	151
8-604023/+	153
8-604023-H	151
8-604023-H/+	153
8-60510041	203
8-60510041-H	203
8-60510042	203
8-60510042-02	203
8-60510042-22	203
8-60510042-23	203
8-60510042-H	203
8-60510042-H-02	203
8-60510042-H-22	203
8-60510042-H-23	203
8-60510043	203
8-60510043-H	203
8-60512041	203
8-60512041-H	203
8-60512042	203
8-60512042-02	203
8-60512042-22	203
8-60512042-23	203
8-60512042-H	203
8-60512042-H-02	203
8-60512042-H-22	203
8-60512042-H-23	203
8-60512043	203
8-60512043-H	203
8-6054021	203
8-6054021-H	203
8-6054022	203
8-6054022-02	203
8-6054022-22	203
8-6054022-23	203
8-6054022-H	203
8-6054022-H-02	203
8-6054022-H-22	203
8-6054022-H-23	203
8-6054023	203
8-6054023-H	203
8-6058031	203
8-6058031-H	203
8-6058032	203
8-6058032-02	203
8-6058032-22	203
8-6058032-23	203
8-6058032-H	203
8-6058032-H-02	203
8-6058032-H-22	203
8-6058032-H-23	203
8-6058033	203
8-6058033-H	203
8-60601	365
8-60602	365
8-60603	365
8-60710041	207
8-60710041-H	207
8-60710042	207
8-60710042-02	207
8-60710042-22	207
8-60710042-23	207
8-60710042-H	207
8-60710042-H-02	207
8-60710042-H-22	207
8-60710042-H-23	207
8-60710043	207
8-60710043-H	207
8-60712041	207
8-60712041-H	207
8-60712042	207
8-60712042-02	207
8-60712042-22	207
8-60712042-23	207
8-60712042-H	207
8-60712042-H-02	207
8-60712042-H-22	207
8-60712042-H-23	207
8-60712043	207
8-60712043-H	207

Produktübersicht Product Overview

Art. Nr. item no.	Seite Page
8-6074021	207
8-6074021-H	207
8-6074022	207
8-6074022-02	207
8-6074022-22	207
8-6074022-23	207
8-6074022-H	207
8-6074022-H-02	207
8-6074022-H-22	207
8-6074022-H-23	207
8-6074023	207
8-6074023-H	207
8-6078031	207
8-6078031-H	207
8-6078032	207
8-6078032-02	207
8-6078032-22	207
8-6078032-23	207
8-6078032-H	207
8-6078032-H-02	207
8-6078032-H-22	207
8-6078032-H-23	207
8-6078033	207
8-6078033-H	207
8-608041	151
8-608041/+	153
8-608041-H	151
8-608041-H/+	153
8-608042	151
8-608042/+	153
8-608042/+-02	153
8-608042/+-22	153
8-608042/+-23	153
8-608042-02	151
8-608042-22	151
8-608042-23	151
8-608042-H	151
8-608042-H/+	153
8-608042-H/+02	153
8-608042-H/+22	153
8-608042-H/+23	153
8-608042-H-02	151
8-608042-H-22	151
8-608042-H-23	151
8-608043	151
8-608043/+	153
8-608043-H	151
8-608043-H/+	153
8-60901	365
8-60902	365
8-60903	365
8-611201	367
8-611202	367
8-611203	367
8-61301	367
8-61302	367
8-61303	367
8-61601	367
8-61602	367
8-61603	367
8-61710041	75
8-61710041-H	75
8-61710042	75
8-61710042-02	75
8-61710042-22	75
8-61710042-23	75
8-61710042-H	75
8-61710042-H-02	75
8-61710042-H-22	75
8-61710042-H-23	75
8-61710043	75
8-61710043-H	75
8-61712041	75
8-61712041-H	75
8-61712042	75
8-61712042-02	75
8-61712042-22	75
8-61712042-23	75
8-61712042-H	75
8-61712042-H-02	75
8-61712042-H-22	75
8-61712042-H-23	75
8-61712043	75
8-61712043-H	75
8-6174021	75
8-6174021-H	75
8-6174022	75
8-6174022-02	75

Art. Nr. item no.	Seite Page
8-6174022-22	75
8-6174022-23	75
8-6174022-H	75
8-6174022-H-02	75
8-6174022-H-22	75
8-6174022-H-23	75
8-6174023	75
8-6174023-H	75
8-6178031	75
8-6178031-H	75
8-6178032	75
8-6178032-02	75
8-6178032-22	75
8-6178032-23	75
8-6178032-H	75
8-6178032-H-02	75
8-6178032-H-22	75
8-6178032-H-23	75
8-6178033	75
8-6178033-H	75
8-61901	367
8-61902	367
8-61903	367
8-622810041	71
8-622810041-H	71
8-622810042	71
8-622810042-02	71
8-622810042-22	71
8-622810042-23	71
8-622810042-H	71
8-622810042-H-02	71
8-622810042-H-22	71
8-622810042-H-23	71
8-622810043	71
8-622810043-H	71
8-622812041	71
8-622812041-H	71
8-622812042	71
8-622812042-02	71
8-622812042-22	71
8-622812042-23	71
8-622812042-H	71
8-622812042-H-02	71
8-622812042-H-22	71
8-622812042-H-23	71
8-622812043	71
8-622812043-H	71
8-62284021	71
8-62284021-H	71
8-62284022	71
8-62284022-02	71
8-62284022-22	71
8-62284022-23	71
8-62284022-H	71
8-62284022-H-02	71
8-62284022-H-22	71
8-62284022-H-23	71
8-62284023	71
8-62284023-H	71
8-62288031	71
8-62288031-H	71
8-62288032	71
8-62288032-02	71
8-62288032-22	71
8-62288032-23	71
8-62288032-H	71
8-62288032-H-02	71
8-62288032-H-22	71
8-62288032-H-23	71
8-62288033	71
8-62288033-H	71
8-62810041	79
8-62810041-H	79
8-62810042	79
8-62810042-02	79
8-62810042-22	79
8-62810042-23	79
8-62810042-H	79
8-62810042-H-02	79
8-62810042-H-22	79
8-62810042-H-23	79
8-62810043	79
8-62810043-H	79
8-62812041	79
8-62812041-H	79
8-62812042	79
8-62812042-02	79
8-62812042-22	79

Art. Nr. item no.	Seite Page
8-62812042-23	79
8-62812042-H	79
8-62812042-H-02	79
8-62812042-H-22	79
8-62812042-H-23	79
8-62812043	79
8-62812043-H	79
8-6284021	79
8-6284021-H	79
8-6284022	79
8-6284022-02	79
8-6284022-22	79
8-6284022-23	79
8-6284022-H	79
8-6284022-H-02	79
8-6284022-H-22	79
8-6284022-H-23	79
8-6284023	79
8-6284023-H	79
8-6288031	79
8-6288031-H	79
8-6288032	79
8-6288032-02	79
8-6288032-22	79
8-6288032-23	79
8-6288032-H	79
8-6288032-H-02	79
8-6288032-H-22	79
8-6288032-H-23	79
8-6288033	79
8-6288033-H	79
8-65810041	81
8-65810041-H	81
8-65810042	81
8-65810042-02	81
8-65810042-22	81
8-65810042-23	81
8-65810042-H	81
8-65810042-H-02	81
8-65810042-H-22	81
8-65810042-H-23	81
8-65810043	81
8-65810043-H	81
8-65812041	81
8-65812041-H	81
8-65812042	81
8-65812042-02	81
8-65812042-22	81
8-65812042-23	81
8-65812042-H	81
8-65812042-H-02	81
8-65812042-H-22	81
8-65812042-H-23	81
8-65812043	81
8-65812043-H	81
8-6584021	81
8-6584021-H	81
8-6584022	81
8-6584022-02	81
8-6584022-22	81
8-6584022-23	81
8-6584022-H	81
8-6584022-H-02	81
8-6584022-H-22	81
8-6584022-H-23	81
8-6584023	81
8-6584023-H	81
8-6588031	81
8-6588031-H	81
8-6588032	81
8-6588032-02	81
8-6588032-22	81
8-6588032-23	81
8-6588032-H	81
8-6588032-H-02	81
8-6588032-H-22	81
8-6588032-H-23	81
8-6588033	81
8-6588033-H	81
8-662810041	73
8-662810041-H	73
8-662810042	73
8-662810042-02	73
8-662810042-22	73
8-662810042-23	73
8-662810042-H	73
8-662810042-H-02	73
8-662810042-H-22	73

Art. Nr. item no.	Seite Page
8-662810042-H-23	73
8-662810043	73
8-662810043-H	73
8-662812041	73
8-662812041-H	73
8-662812042	73
8-662812042-02	73
8-662812042-22	73
8-662812042-23	73
8-662812042-H	73
8-662812042-H-02	73
8-662812042-H-22	73
8-662812042-H-23	73
8-662812043	73
8-662812043-H	73
8-66284021	73
8-66284021-H	73
8-66284022	73
8-66284022-02	73
8-66284022-22	73
8-66284022-23	73
8-66284022-H	73
8-66284022-H-02	73
8-66284022-H-22	73
8-66284022-H-23	73
8-66284023	73
8-66284023-H	73
8-66288031	73
8-66288031-H	73
8-66288032	73
8-66288032-02	73
8-66288032-22	73
8-66288032-23	73
8-66288032-H	73
8-66288032-H-02	73
8-66288032-H-22	73
8-66288032-H-23	73
8-66288033	73
8-66288033-H	73
8-68510041	205
8-68510041-H	205
8-68510042	205
8-68510042-02	205
8-68510042-22	205
8-68510042-23	205
8-68510042-H	205
8-68510042-H-02	205
8-68510042-H-22	205
8-68510042-H-23	205
8-68510043	205
8-68510043-H	205
8-68512041	205
8-68512041-H	205
8-68512042	205
8-68512042-02	205
8-68512042-22	205
8-68512042-23	205
8-68512042-H	205
8-68512042-H-02	205
8-68512042-H-22	205
8-68512042-H-23	205
8-68512043	205
8-68512043-H	205
8-6854021	205
8-6854021-H	205
8-6854022	205
8-6854022-02	205
8-6854022-22	205
8-6854022-23	205
8-6854022-H	205
8-6854022-H-02	205
8-6854022-H-22	205
8-6854022-H-23	205
8-6854023	205
8-6854023-H	205
8-6858031	205
8-6858031-H	205
8-6858032	205
8-6858032-02	205
8-6858032-22	205
8-6858032-23	205
8-6858032-H	205
8-6858032-H-02	205
8-6858032-H-22	205
8-6858032-H-23	205
8-6858033	205
8-6858033-H	205
8-68710041	209

Art. Nr. item no.	Seite Page
8-68710041-H	209
8-68710042	209
8-68710042-02	209
8-68710042-22	209
8-68710042-23	209
8-68710042-H	209
8-68710042-H-02	209
8-68710042-H-22	209
8-68710042-H-23	209
8-68710043	209
8-68710043-H	209
8-68712041	209
8-68712041-H	209
8-68712042	209
8-68712042-02	209
8-68712042-22	209
8-68712042-23	209
8-68712042-H	209
8-68712042-H-02	209
8-68712042-H-22	209
8-68712042-H-23	209
8-68712043	209
8-68712043-H	209
8-6874021	209
8-6874021-H	209
8-6874022	209
8-6874022-02	209
8-6874022-22	209
8-6874022-23	209
8-6874022-H	209
8-6874022-H-02	209
8-6874022-H-22	209
8-6874022-H-23	209
8-6874023	209
8-6874023-H	209
8-6878031	209
8-6878031-H	209
8-6878032	209
8-6878032-02	209
8-6878032-22	209
8-6878032-23	209
8-6878032-H	209
8-6878032-H-02	209
8-6878032-H-22	209
8-6878032-H-23	209
8-6878033	209
8-6878033-H	209
8-69710041	77
8-69710041-H	77
8-69710042	77
8-69710042-02	77
8-69710042-22	77
8-69710042-23	77
8-69710042-H	77
8-69710042-H-02	77
8-69710042-H-22	77
8-69710042-H-23	77
8-69710043	77
8-69710043-H	77
8-69712041	77
8-69712041-H	77
8-69712042	77
8-69712042-02	77
8-69712042-22	77
8-69712042-23	77
8-69712042-H	77
8-69712042-H-02	77
8-69712042-H-22	77
8-69712042-H-23	77
8-69712043	77
8-69712043-H	77
8-6974021	77
8-6974021-H	77
8-6974022	77
8-6974022-02	77
8-6974022-22	77
8-6974022-23	77
8-6974022-H	77
8-6974022-H-02	77
8-6974022-H-22	77
8-6974022-H-23	77
8-6974023	77
8-6974023-H	77
8-6978031	77
8-6978031-H	77
8-6978032	77
8-6978032-02	77
8-6978032-22	77

Art. Nr. item no.	Seite Page
8-6978032-23	77
8-6978032-H	77
8-6978032-H-02	77
8-6978032-H-22	77
8-6978032-H-23	77
8-6978033	77
8-6978033-H	77
8-7113010041	227
8-7113010042	227
8-7113010042-02	227
8-7113010042-22	227
8-7113010042-23	227
8-7113010043	227
8-7113012041	227
8-7113012042	227
8-7113012042-02	227
8-7113012042-22	227
8-7113012042-23	227
8-7113012043	227
8-711304021	227
8-711304022	227
8-711304022-02	227
8-711304022-22	227
8-711304022-23	227
8-711304023	227
8-711306031	227
8-711306032	227
8-711306032-02	227
8-711306032-22	227
8-711306032-23	227
8-711306033	227
8-7121010041	227
8-7121010042	227
8-7121010042-02	227
8-7121010042-22	227
8-7121010042-23	227
8-7121010043	227
8-7121012041	227
8-7121012042	227
8-7121012042-02	227
8-7121012042-22	227
8-7121012042-23	227
8-7121012043	227
8-712108031	227
8-712108032	227
8-712108032-02	227
8-712108032-22	227
8-712108032-23	227
8-712108033	227
8-719010041	227
8-719010042	227
8-719010042-02	227
8-719010042-22	227
8-719010042-23	227
8-719010043	227
8-719012041	227
8-719012042	227
8-719012042-02	227
8-719012042-22	227
8-719012042-23	227
8-719012043	227
8-71904021	227
8-71904022	227
8-71904022-02	227
8-71904022-22	227
8-71904022-23	227
8-71904023	227
8-71908031	227
8-71908032	227
8-71908032-02	227
8-71908032-22	227
8-71908032-23	227
8-71908033	227
8-7213010041	95
8-7213010042	95
8-7213010042-02	95
8-7213010042-22	95
8-7213010042-23	95
8-7213010043	95
8-7213012041	95
8-7213012042	95
8-7213012042-02	95
8-7213012042-22	95
8-7213012042-23	95
8-7213012043	95
8-721304021	95
8-721304022	95
8-721304022-02	95

Produktübersicht Product Overview

Art. Nr. item no.	Seite Page
8-721304022-22	95
8-721304022-23	95
8-721304023	95
8-721306031	95
8-721306032	95
8-721306032-02	95
8-721306032-22	95
8-721306032-23	95
8-721306033	95
8-7221010041	95
8-7221010042	95
8-7221010042-02	95
8-7221010042-22	95
8-7221010042-23	95
8-7221010043	95
8-7221012041	95
8-7221012042	95
8-7221012042-02	95
8-7221012042-22	95
8-7221012042-23	95
8-7221012043	95
8-722108031	95
8-722108032	95
8-722108032-02	95
8-722108032-22	95
8-722108032-23	95
8-722108033	95
8-729010041	95
8-729010042	95
8-729010042-02	95
8-729010042-22	95
8-729010042-23	95
8-729010043	95
8-729012041	95
8-729012042	95
8-729012042-02	95
8-729012042-22	95
8-729012042-23	95
8-729012043	95
8-72904021	95
8-72904022	95
8-72904022-02	95
8-72904022-22	95
8-72904022-23	95
8-72904023	95
8-72906031	95
8-72906032	95
8-72906032-02	95
8-72906032-22	95
8-72906032-23	95
8-72906033	95
8-7313010041	97
8-7313010042	97
8-7313010042-02	97
8-7313010042-22	97
8-7313010042-23	97
8-7313010043	97
8-7313012041	97
8-7313012042	97
8-7313012042-02	97
8-7313012042-22	97
8-7313012042-23	97
8-7313012043	97
8-731304021	97
8-731304022	97
8-731304022-02	97
8-731304022-22	97
8-731304022-23	97
8-731304023	97
8-731306031	97
8-731306032	97
8-731306032-02	97
8-731306032-22	97
8-731306032-23	97
8-731306033	97
8-7321010041	97
8-7321010042	97
8-7321010042-02	97
8-7321010042-22	97
8-7321010042-23	97
8-7321010043	97
8-7321012041	97
8-7321012042	97
8-7321012042-02	97
8-7321012042-22	97
8-7321012042-23	97
8-7321012043	97
8-7321012043	97
8-732108031	97

Art. Nr. item no.	Seite Page
8-732108032	97
8-732108032-02	97
8-732108032-22	97
8-732108032-23	97
8-732108033	97
8-739010041	97
8-739010042	97
8-739010042-02	97
8-739010042-22	97
8-739010042-23	97
8-739010043	97
8-739012041	97
8-739012042	97
8-739012042-02	97
8-739012042-22	97
8-739012042-23	97
8-739012043	97
8-73904021	97
8-73904022	97
8-73904022-02	97
8-73904022-22	97
8-73904022-23	97
8-73904023	97
8-73906031	97
8-73906032	97
8-73906032-02	97
8-73906032-22	97
8-73906032-23	97
8-73906033	97
8-7610041	233
8-7610042	233
8-7612041	233
8-7612042	233
8-764021	233
8-764022	233
8-768031	233
8-768032	233
8-7691001	67
8-7691001-H	67
8-7691002	67
8-7691002-02	67
8-7691002-22	67
8-7691002-23	67
8-7691002-H	67
8-7691002-H-02	67
8-7691002-H-22	67
8-7691002-H-23	67
8-7691003	67
8-7691003-H	67
8-7691201	67
8-7691201-H	67
8-7691202	67
8-7691202-02	67
8-7691202-22	67
8-7691202-23	67
8-7691202-H	67
8-7691202-H-02	67
8-7691202-H-22	67
8-7691203	67
8-7691203-H	67
8-769401	67
8-769401-H	67
8-769402	67
8-769402-02	67
8-769402-22	67
8-769402-23	67
8-769402-H	67
8-769402-H-02	67
8-769402-H-22	67
8-769402-H-23	67
8-769403	67
8-769403-H	67
8-769801	67
8-769801-H	67
8-769802	67
8-769802-02	67
8-769802-22	67
8-769802-23	67
8-769802-H	67
8-769802-H-02	67
8-769802-H-22	67
8-769802-H-23	67
8-769803	67
8-769803-H	67
8-7710041	233
8-7710042	233
8-7712041	233

Art. Nr. item no.	Seite Page
8-774021	233
8-774022	233
8-778031	233
8-778032	233
8-7891001	69
8-7891001-H	69
8-7891002	69
8-7891002-02	69
8-7891002-22	69
8-7891002-23	69
8-7891002-H	69
8-7891002-H-02	69
8-7891002-H-22	69
8-7891002-H-23	69
8-7891003	69
8-7891003-H	69
8-7891201	69
8-7891201-H	69
8-7891202	69
8-7891202-02	69
8-7891202-22	69
8-7891202-23	69
8-7891202-H	69
8-7891202-H-02	69
8-7891202-H-22	69
8-7891202-H-23	69
8-7891203	69
8-7891203-H	69
8-789401	69
8-789401-H	69
8-789402	69
8-789402-02	69
8-789402-22	69
8-789402-23	69
8-789402-H	69
8-789402-H-02	69
8-789402-H-22	69
8-789402-H-23	69
8-789403	69
8-789403-H	69
8-789801	69
8-789801-H	69
8-789802	69
8-789802-02	69
8-789802-22	69
8-789802-23	69
8-789802-H	69
8-789802-H-02	69
8-789802-H-22	69
8-789802-H-23	69
8-789803	69
8-789803-H	69
8-7910041	237
8-7910042	237
8-7910042-02	237
8-7910042-22	237
8-7912041	237
8-7912042	237
8-7912042-02	237
8-7912042-22	237
8-794021	237
8-794022	237
8-794022-02	237
8-794022-22	237
8-798031	237
8-798032	237
8-798032-02	237
8-798032-22	237
9-110	473
9-111	473
9-12002	101
9-12004	101
9-12005	101
9-12009	101
9-200	101
9-201	101
9-204	173

Kataloge Catalogs



Art.-Nr. 10-100 DIN-A4 494 Seiten



Art.-Nr. 10-168 DIN-A4 52 Seiten

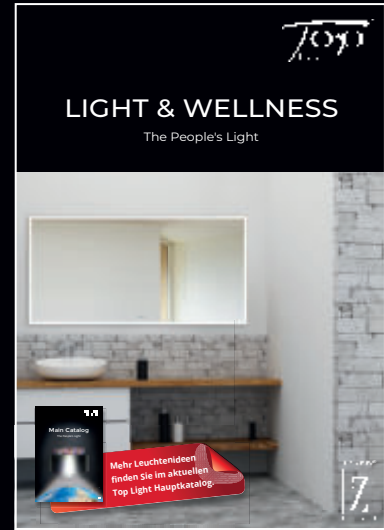

Art.-Nr. 10-169 DIN-A4 112 Seiten



Art.-Nr. 10-229 DIN-A4 52 Seiten



Art.-Nr. 10-700 DIN-A4 24 Seiten

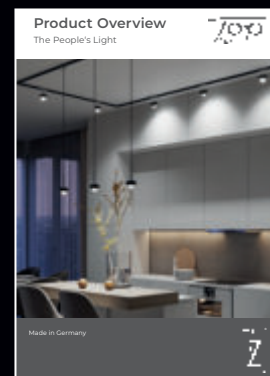

Art.-Nr. 10-102 DIN-A5 100 Seiten



Art.-Nr. OO-10-100 DIN-A4 116 Seiten

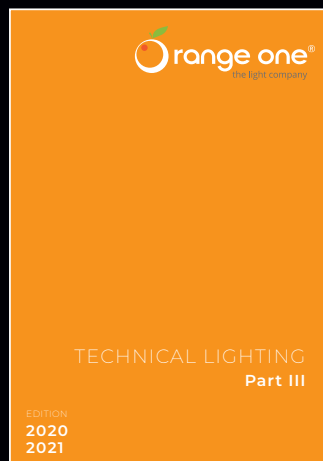

Art.-Nr. OO-10-103 88 Seiten

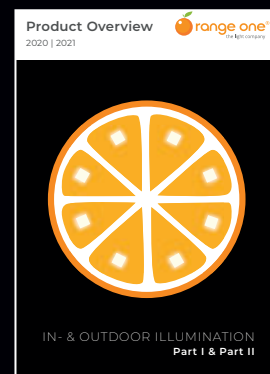

Art.-Nr. OO-10-110 DIN-A4 40 Seiten

Equipment

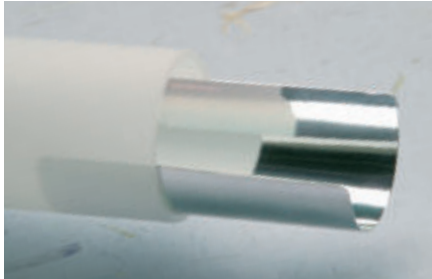

Reflektor "Option": Aluminium-Hochleistungsreflektor, einfache Montage durch Einschub in den Glastubus.

Baffle "option": High performance aluminium baffle, easy installation: slides into the glass tube.

Art.-Nr. 9-204



Touchme: transparenter Schnurdimmer mit Memofunktion (optional)

Touchme: transparent cable dimmer with memory function (optional)

Art.-Nr.-D

Schirmfarben für Silk (Chinz) Shade colors for Silk (Chinz)

- SI-100DB 
- SI-100RO 
- SI-100HB 
- SI-100GB 
- SI-100TK 
- SI-100GR 
- SI-100O 
- SI-100V 
- SI-100S 
- SI-100W 
- SI-100R 

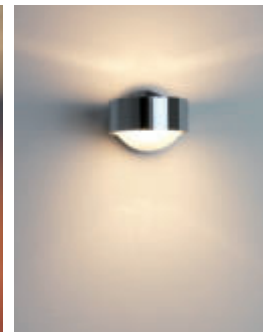
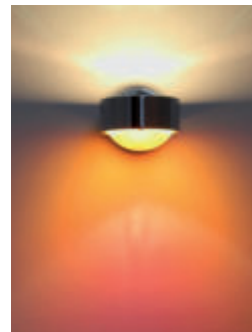

mattierte Linse mit und ohne Farbfilter
frosted lens with and without color filter

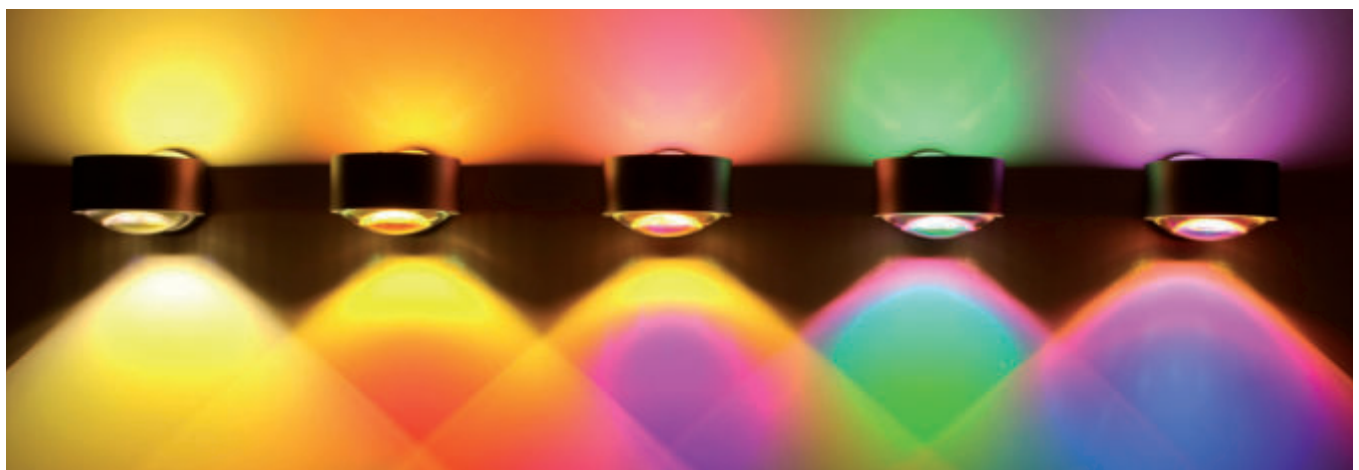

gelb yellow

rot red

magenta magenta

grün green

blau blue

Puk Equipment

Puk Mini 80 Zubehör

Art. Nr. item no.	Einsatz insert	Beschreibung description
2-2025	Alurefektor, aluminium baffle	Lichtstopp, empfohlen unter Glas lightstop, recommended under glass
2-2026	Linse, lens	klar, clear
2-2026-s	Linse, lens	einseitig mattiert, frosted on one side
2-2027	Glas, glass	beidseitig mattiert, passt nicht unter Linse frosted on both sides, doesn't fit under lens
2-2045	Soft-Glas, soft glass	für weiche Lichtverteilung unter der Linse for a soft light distribution under the lens
2-2028	Farbfilter nur unter Glas oder Linse color filter only under glass or lens	rot, red
2-2029		magenta, magenta
2-2030		gelb, yellow
2-2033		blau, blue
2-2034		grün, green

Puk Maxx 120 Zubehör

Art. Nr. item no.	Einsatz insert	Beschreibung description
2-3035	Alurefektor, aluminium baffle	Lichtstopp, empfohlen unter Glas lightstop, recommended under glass
2-3036	Linse, lens	klar, clear
2-3036-s	Linse, lens	einseitig mattiert, frosted on one side
2-3037	Glas, glass	beidseitig mattiert, passt nicht unter Linse frosted on both sides, doesn't fit under lens
2-3045	Soft-Glas, soft glass	für weiche Lichtverteilung unter der Linse for a soft light distribution under the lens
Indoor:		
2-3038	Farbfilter nur unter Glas oder Linse color filter only under glass or lens	rot, red
2-3039		magenta, magenta
2-3040		gelb, yellow
2-3043		blau, blue
2-3044		grün, green

Indoor:

2-4038	Farbfilter nur unter Glas oder Linse color filter only under glass or lens	rot, red
2-4039		magenta, magenta
2-4040		gelb, yellow
2-4043		blau, blue
2-4044		grün, green

Outdoor:

2-4038	Farbfilter nur unter Glas oder Linse color filter only under glass or lens	rot, red
2-4039		magenta, magenta
2-4040		gelb, yellow
2-4043		blau, blue
2-4044		grün, green

Puk Meg Maxx 160 Zubehör

Art. Nr. item no.	Einsatz insert	Beschreibung description
2-5035	Alurefektor, aluminium baffle	Lichtstopp, empfohlen unter Glas lightstop, recommended under glass
2-5036	Linse, lens	klar, clear
2-5036-s	Linse, lens	einseitig mattiert, frosted on one side
2-5037	Glas, glass	beidseitig mattiert, passt nicht unter Linse frosted on both sides, doesn't fit under lens
2-5038	Farbfilter nur unter Glas oder Linse color filter only under glass or lens	rot, red
2-5039		magenta, magenta
2-5040		gelb, yellow
2-5043		blau, blue
2-5044		grün, green

Linsen, Gläser und Farbfilter frei kombinierbar.
Lenses, glasses and color filter freely selectable.

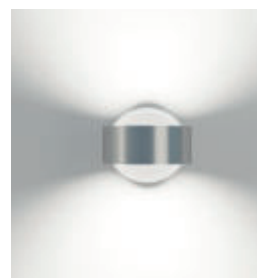
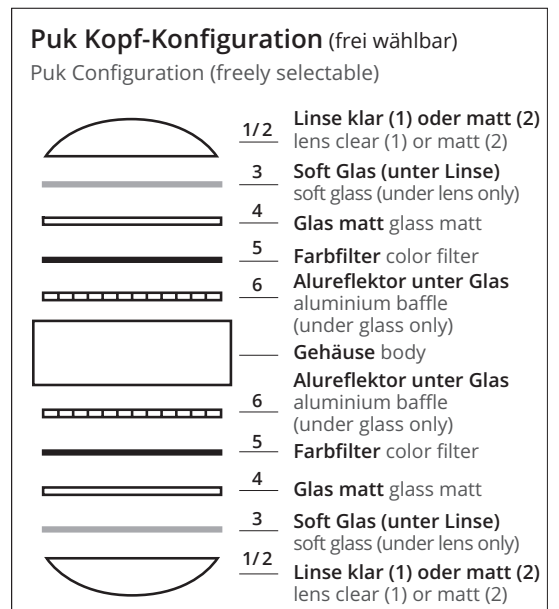

Linse matt lens matt



Linse klar lens clear

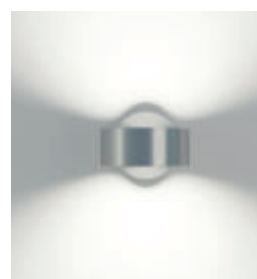

Glas matt glass matt

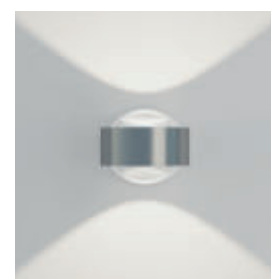

2 x Soft Glas/Linse
2 x soft glass/lens

Textilkabel/textile cable:

Art. Nr. item no.	Farbe color
+Art-Nr. 7-980	transparent
+Art-Nr. 7-987	white
+Art-Nr. 7-982	orange
+Art-Nr. 7-983	red
+Art-Nr. 7-988	anthracite
+Art-Nr. 7-986	black
+Art-Nr. 5-07951	Kabelverlängerung pro 1 m cable extension each 1 m





Design by[®]

R
Z

Ralf Ziel

Ralf Ziel

Follow us:



Top Light GmbH & Co. KG
Industriezentrum 100
32139 Spenge

fon +49 (0) 52 25 . 8 63 12 - 0
fax +49 (0) 52 25 . 8 63 12 - 10

www.top-light.de
brief@top-light.de
www.orange-one.de

